



RX-V3800

AV Receiver

OWNER'S MANUAL

Important safety instructions

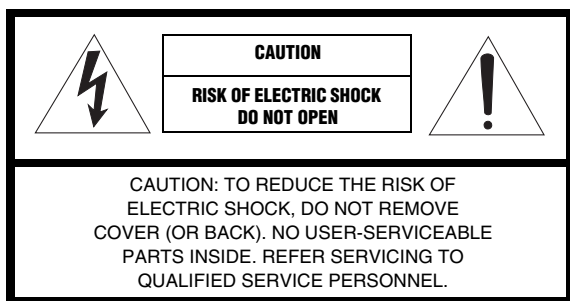

• Explanation of Graphical Symbols



The lightning flash with arrowhead symbol, within an equilateral triangle, is intended to alert you to the presence of uninsulated “dangerous voltage” within the product’s enclosure that may be of sufficient magnitude to constitute a risk of electric shock to persons.



The exclamation point within an equilateral triangle is intended to alert you to the presence of important operating and maintenance (servicing) instructions in the literature accompanying the appliance.

- 1 Read Instructions – All the safety and operating instructions should be read before the product is operated.
 - 2 Retain Instructions – The safety and operating instructions should be retained for future reference.
 - 3 Heed Warnings – All warnings on the product and in the operating instructions should be adhered to.
 - 4 Follow Instructions – All operating and use instructions should be followed.
 - 5 Cleaning – Unplug this product from the wall outlet before cleaning. Do not use liquid cleaners or aerosol cleaners.
 - 6 Attachments – Do not use attachments not recommended by the product manufacturer as they may cause hazards.
 - 7 Water and Moisture – Do not use this product near water – for example, near a bath tub, wash bowl, kitchen sink, or laundry tub; in a wet basement; or near a swimming pool; and the like.
 - 8 Accessories – Do not place this product on an unstable cart, stand, tripod, bracket, or table. The product may fall, causing serious injury to a child or adult, and serious damage to the product. Use only with a cart, stand, tripod, bracket, or table recommended by the manufacturer, or sold with the product. Any mounting of the product should follow the manufacturer’s instructions, and should use a mounting accessory recommended by the manufacturer.
 - 9 A product and cart combination should be moved with care. Quick stops, excessive force, and uneven surfaces may cause the product and cart combination to overturn.
- 
- 10 Ventilation – Slots and openings in the cabinet are provided for ventilation and to ensure reliable operation of the product and to protect it from overheating, and these openings must not be blocked or covered. The openings should never be blocked by placing the product on a bed, sofa, rug, or other similar surface. This product should not be placed in a built-in installation such as a bookcase or rack unless proper ventilation is provided or the manufacturer’s instructions have been adhered to.
 - 11 Power Sources – This product should be operated only from the type of power source indicated on the marking label. If you are not sure of the type of power supply to your home, consult your product dealer or local power company. For products intended to operate from battery power, or other sources, refer to the operating instructions.
 - 12 Grounding or Polarization – This product may be equipped with a polarized alternating current line plug (a plug having one blade wider than the other). This plug will fit into the power outlet only one way. This is a safety feature. If you are unable to insert the plug fully into the outlet, try reversing the plug. If the plug should still fail to fit, contact your electrician to replace your obsolete outlet. Do not defeat the safety purpose of the polarized plug.
 - 13 Power-Cord Protection – Power-supply cords should be routed so that they are not likely to be walked on or pinched by items placed upon or against them, paying particular attention to cords at plugs, convenience receptacles, and the point where they exit from the product.
 - 14 Lightning – For added protection for this product during a lightning storm, or when it is left unattended and unused for long periods of time, unplug it from the wall outlet and disconnect the antenna or cable system. This will prevent damage to the product due to lightning and power-line surges.
 - 15 Power Lines – An outside antenna system should not be located in the vicinity of overhead power lines or other electric light or power circuits, or where it can fall into such power lines or circuits. When installing an outside antenna system, extreme care should be taken to keep from touching such power lines or circuits as contact with them might be fatal.
 - 16 Overloading – Do not overload wall outlets, extension cords, or integral convenience receptacles as this can result in a risk of fire or electric shock.
 - 17 Object and Liquid Entry – Never push objects of any kind into this product through openings as they may touch dangerous voltage points or short-out parts that could result in a fire or electric shock. Never spill liquid of any kind on the product.
 - 18 Servicing – Do not attempt to service this product yourself as opening or removing covers may expose you to dangerous voltage or other hazards. Refer all servicing to qualified service personnel.
 - 19 Damage Requiring Service – Unplug this product from the wall outlet and refer servicing to qualified service personnel under the following conditions:
 - a) When the power-supply cord or plug is damaged,
 - b) If liquid has been spilled, or objects have fallen into the product,
 - c) If the product has been exposed to rain or water,

- d) If the product does not operate normally by following the operating instructions. Adjust only those controls that are covered by the operating instructions as an improper adjustment of other controls may result in damage and will often require extensive work by a qualified technician to restore the product to its normal operation,
 - e) If the product has been dropped or damaged in any way, and
 - f) When the product exhibits a distinct change in performance - this indicates a need for service.
- 20 Replacement Parts** – When replacement parts are required, be sure the service technician has used replacement parts specified by the manufacturer or have the same characteristics as the original part. Unauthorized substitutions may result in fire, electric shock, or other hazards.
- 21 Safety Check** – Upon completion of any service or repairs to this product, ask the service technician to perform safety checks to determine that the product is in proper operating condition.
- 22 Wall or Ceiling Mounting** – The unit should be mounted to a wall or ceiling only as recommended by the manufacturer.
- 23 Heat** – The product should be situated away from heat sources such as radiators, heat registers, stoves, or other products (including amplifiers) that produce heat.

- 24 Outdoor Antenna Grounding** – If an outside antenna or cable system is connected to the product, be sure the antenna or cable system is grounded so as to provide some protection against voltage surges and built-up static charges. Article 810 of the National Electrical Code, ANSI/NFPA 70, provides information with regard to proper grounding of the mast and supporting structure, grounding of the lead-in wire to an antenna discharge unit, size of grounding conductors, location of antenna discharge unit, connection to grounding electrodes, and requirements for the grounding electrode.

EXAMPLE OF ANTENNA GROUNDING

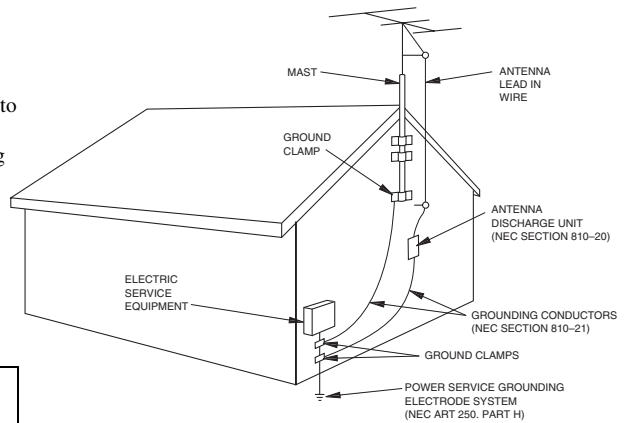

NEC – NATIONAL ELECTRICAL CODE

Note to CATV system installer:

This reminder is provided to call the CATV system installer’s attention to Article 820-40 of the NEC that provides guidelines for proper grounding and, in particular, specifies that the cable ground shall be connected to the grounding system of the building, as close to the point of cable entry as practical.

FCC INFORMATION (for US customers)

1 IMPORTANT NOTICE: DO NOT MODIFY THIS UNIT!

This product, when installed as indicated in the instructions contained in this manual, meets FCC requirements. Modifications not expressly approved by Yamaha may void your authority, granted by the FCC, to use the product.

- 2 IMPORTANT:** When connecting this product to accessories and/or another product use only high quality shielded cables. Cable/s supplied with this product **MUST** be used. Follow all installation instructions. Failure to follow instructions could void your FCC authorization to use this product in the USA.

- 3 NOTE:** This product has been tested and found to comply with the requirements listed in FCC Regulations, Part 15 for Class “B” digital devices. Compliance with these requirements provides a reasonable level of assurance that your use of this product in a residential environment will not result in harmful interference with other electronic devices.

This equipment generates/uses radio frequencies and, if not installed and used according to the instructions found in the users manual, may cause interference harmful to the operation of other electronic devices.

Compliance with FCC regulations does not guarantee that interference will not occur in all installations. If this product is found to be the source of interference, which can be determined by turning the unit “OFF” and “ON”, please try to eliminate the problem by using one of the following measures:

Relocate either this product or the device that is being affected by the interference.

Utilize power outlets that are on different branch (circuit breaker or fuse) circuits or install AC line filter/s.

In the case of radio or TV interference, relocate/reorient the antenna. If the antenna lead-in is 300 ohm ribbon lead, change the lead-in to coaxial type cable.

If these corrective measures do not produce satisfactory results, please contact the local retailer authorized to distribute this type of product. If you can not locate the appropriate retailer, please contact Yamaha Electronics Corp., U.S.A. 6660 Orangethorpe Ave, Buena Park, CA 90620.

The above statements apply **ONLY** to those products distributed by Yamaha Corporation of America or its subsidiaries.

Caution: read this before operating your unit.

- 1 To assure the finest performance, please read this manual carefully. Keep it in a safe place for future reference.
- 2 Install this sound system in a well ventilated, cool, dry, clean place – away from direct sunlight, heat sources, vibration, dust, moisture, and/or cold. Allow ventilation space of at least 30 cm on the top, 20 cm on the left and right, and 20 cm on the back of this unit.
- 3 Locate this unit away from other electrical appliances, motors, or transformers to avoid humming sounds.
- 4 Do not expose this unit to sudden temperature changes from cold to hot, and do not locate this unit in an environment with high humidity (i.e. a room with a humidifier) to prevent condensation inside this unit, which may cause an electrical shock, fire, damage to this unit, and/or personal injury.
- 5 Avoid installing this unit where foreign objects may fall onto this unit and/or this unit may be exposed to liquid dripping or splashing. On the top of this unit, do not place:
 - Other components, as they may cause damage and/or discoloration on the surface of this unit.
 - Burning objects (i.e. candles), as they may cause fire, damage to this unit, and/or personal injury.
 - Containers with liquid in them, as they may fall and liquid may cause electrical shock to the user and/or damage to this unit.
- 6 Do not cover this unit with a newspaper, tablecloth, curtain, etc. in order not to obstruct heat radiation. If the temperature inside this unit rises, it may cause fire, damage to this unit, and/or personal injury.
- 7 Do not plug in this unit to a wall outlet until all connections are complete.
- 8 Do not operate this unit upside-down. It may overheat, possibly causing damage.
- 9 Do not use force on switches, knobs and/or cords.
- 10 When disconnecting the power cable from the wall outlet, grasp the plug; do not pull the cable.
- 11 Do not clean this unit with chemical solvents; this might damage the finish. Use a clean, dry cloth.
- 12 Only voltage specified on this unit must be used. Using this unit with a higher voltage than specified is dangerous and may cause fire, damage to this unit, and/or personal injury. Yamaha will not be held responsible for any damage resulting from use of this unit with a voltage other than specified.
- 13 To prevent damage by lightning, keep the power cord and outdoor antennas disconnected from a wall outlet or the unit during a lightning storm.
- 14 Do not attempt to modify or fix this unit. Contact qualified Yamaha service personnel when any service is needed. The cabinet should never be opened for any reasons.
- 15 When not planning to use this unit for long periods of time (i.e. vacation), disconnect the AC power plug from the wall outlet.
- 16 Install this unit near the AC outlet and where the AC power plug can be reached easily.
- 17 Be sure to read the “Troubleshooting” section on common operating errors before concluding that this unit is faulty.
- 18 Before moving this unit, press **Ⓐ MASTER ON/OFF** to release it outward to the OFF position to turn off this unit, the main room, Zone 2 and Zone 3 and then disconnect the AC power plug from the AC wall outlet.
- 19 **VOLTAGE SELECTOR** (Asia and General models only)
The **VOLTAGE SELECTOR** on the rear panel of this unit must be set for your local main voltage **BEFORE** plugging into the AC wall outlet. Voltages are as follows:
..... 110/120/220/230–240 V AC, 50/60 Hz
- 20 The batteries shall not be exposed to excessive heat such as sunshine, fire or like.
- 21 Excessive sound pressure from earphones and headphones can cause hearing loss.

WARNING

TO REDUCE THE RISK OF FIRE OR ELECTRIC SHOCK, DO NOT EXPOSE THIS UNIT TO RAIN OR MOISTURE.

As long as this unit is connected to the AC wall outlet, it is not disconnected from the AC power source even if you turn off this unit by **Ⓐ MASTER ON/OFF**. In this state, this unit is designed to consume a very small quantity of power.

FOR CANADIAN CUSTOMERS

To prevent electric shock, match wide blade of plug to wide slot and fully insert.
This Class B digital apparatus complies with Canadian ICES-003.

POUR LES CONSOMMATEURS CANADIENS

Pour éviter les chocs électriques, introduire la lame la plus large de la fiche dans la borne correspondante de la prise et pousser jusqu'au fond.
Cet appareil numérique de la classe B est conforme à la norme NMB-003 du Canada.

IMPORTANT

Please record the serial number of this unit in the space below.

MODEL:

Serial No.:

The serial number is located on the rear of the unit.

Retain this Owner's Manual in a safe place for future reference.

COMPLIANCE INFORMATION STATEMENT (DECLARATION OF CONFORMITY PROCEDURE)

Responsible Party: Yamaha Electronics Corporation, U.S.A.
Address: 6660 Orangethorpe Avenue
Buena Park, CA 90620
Telephone: 714-522-9105
Fax: 714-670-0108
Type of Equipment: AV Receiver
Model Name: RX-V3800

- This device complies with Part 15 of the FCC Rules.
 - Operation is subject to the following conditions:
 - This device may not cause harmful interference.
 - This device must accept any interference received including interference that may cause undesired operation.
- See the “Troubleshooting” section at the end of this manual if interference to radio reception is suspected.

Contents

INTRODUCTION

Notices.....	2
Features	3
Supplied accessories	4
Getting started	5
Quick start guide	6

PREPARATION

Connections	12
Optimizing the speaker setting for your listening room (YPAO)	37
Using the automatic setup (Auto Setup).....	37

BASIC OPERATION

Playback	41
Basic procedure	41
Selecting audio input jacks (AUDIO SELECT).....	42
Selecting the MULTI CH INPUT component.....	42
Using your headphones.....	42
Muting the audio output.....	43
Playing video sources in the background of an audio source.....	43
Using the sleep timer	43
Operating the amplifier functions of this unit by using the graphical user interface (GUI) screen.....	44
Sound field programs	45
Selecting sound field programs	45
Sound field program descriptions.....	45
Using CINEMA DSP 3D mode.....	50
Enjoying unprocessed input sources.....	50
Using audio features.....	51
Enjoying pure hi-fi sound	51
Adjusting the tonal quality.....	51
Adjusting the speaker level.....	52
Enjoying multi-channel sources in 2-channel stereo	52
FM/AM tuning	53
Automatic tuning	53
Manual tuning	53
Automatic preset tuning.....	54
Manual preset tuning	54
Selecting preset stations.....	55
Exchanging preset stations	55
XM™ Satellite Radio tuning	56
Connecting the XM™ Mini-Tuner Home Dock.....	56
Activating XM™ Satellite Radio	57
Basic XM™ Satellite Radio operations.....	57
Setting the XM™ Satellite Radio preset channels.....	59
Displaying the XM™ Satellite Radio information	60
Using iPod™.....	62
Controlling iPod™.....	62
Using Network/USB features.....	64
Navigating the network and USB menus.....	64
Using a PC server or Yamaha MCX-2000	66
Using the Internet Radio.....	67
Using a USB memory device or a USB portable audio player	68
Using shortcut buttons	68
Recording	70

ADVANCED OPERATION

Advanced sound configurations.....	71
Selecting decoders	71
Graphical user interface (GUI) screen.....	73
Stereo/Surround (Stereo/Surround menu)	74
Input Select	81
Manual Setup (Volume)	84
Manual Setup (Sound)	85
Manual Setup (Video)	89
Manual Setup (Basic)	91
Manual Setup (NET/USB).....	94
Manual Setup (Option)	96
Signal Info. (Input signal information).....	98
Language	99
Saving and recalling the system settings (System Memory)	100
Saving the current system settings.....	100
Loading the stored system settings	101
Using examples.....	102
Remote control features.....	105
Controlling this unit, a TV, or other components.....	105
Setting remote control codes	107
Programming codes from other remote controls	109
Changing source names in the display window	110
Macro programming features	111
Clearing configurations	114
Using multi-zone configuration.....	117
Connecting the Zone 2 and Zone 3 components	117
Controlling Zone 2 or Zone 3	118
Advanced setup.....	122
Using the advanced setup menu	122

ADDITIONAL INFORMATION

Troubleshooting.....	127
Resetting the system.....	137
Glossary.....	138
Sound field program information.....	142
Parametric equalizer information	143
Specifications	144
Index	146

APPENDIX

(at the end of this manual)

Front Panel.....	i
Remote Control	ii
Sound output in each sound field program.....	iii
GPL/LGPL.....	v
List of remote control codes	ix

“**A** MASTER ON/OFF” or “**1** DVD” (example) indicates the name of the parts on the front panel or the remote control. Refer to the attached sheet or the pages at the end of this manual for the information about each position of the parts.

INTRODUCTION

PREPARATION

BASIC
OPERATION

ADVANCED
OPERATION





ADDITIONAL
INFORMATION

APPENDIX

English

Notices

About this manual

-  indicates a tip for your operation.
- Some operations can be performed by using either the buttons on the front panel or the ones on the remote control. In case the button names differ between the front panel and the remote control, the button name on the remote control is given in parentheses.
- This manual is printed prior to production. Design and specifications are subject to change in part as a result of improvements, etc. In case of differences between the manual and product, the product has priority.
- This unit is equipped with GUI display menu language switching capability. In this manual, the illustrations of the GUI are examples when you set the GUI language to English.
- “ MASTER ON/OFF” or “ DVD” (example) indicates the name of the parts on the front panel or the remote control. Refer to the attached sheet or the pages at the end of this manual for the information about each position of the parts.
- The symbol “ ” with page number(s) indicates the corresponding reference page(s).

Note on source code distribution

This product includes software code subject to the GNU General Public License (GPL) or the GNU Lesser General Public License (LGPL). The copy, distribution, or change of this software code is licensed under the terms of the GPL or the LGPL. The source code is available at the following website:
<http://www.global.yamaha.com/download/>

The source code is also available on a physical media (such as a CD-ROM) at actual cost.

Contact: AV products division, YAMAHA CORPORATION,
10-1 Nakazawa-cho, Naka-ku, Hamamatsu 430-8650,
Japan

In principle, the source code is offered for 3 years from the day of purchase.

We Want You Listening For A Lifetime



Yamaha and the Electronic Industries Association's Consumer Electronics Group want you to get the most out of your equipment by playing it at a safe level. One that lets the sound come through loud and clear without annoying blaring or distortion – and, most importantly, without affecting your sensitive hearing. Since hearing damage from loud sounds is often undetectable until it is too late, Yamaha and the Electronic Industries Association's Consumer Electronics Group recommend you to avoid prolonged exposure from excessive volume levels.



Manufactured under license from Dolby Laboratories.
“Dolby”, “Pro Logic”, and the double-D symbol are trademarks of Dolby Laboratories.



Manufactured under license under U.S. Patent No's: 5,451,942;5,956,674;5,974,380;5,978,762;6,226,616;6,487,535 & other U.S. and worldwide patents issued & pending. DTS is a registered trademark and the DTS logos, Symbol, DTS-HD and DTS-HD Master Audio are trademark of DTS, Inc. © 1996-2007 DTS, Inc. All Rights Reserved.

iPod™

“iPod” is a trademark of Apple Inc., registered in the U.S. and other countries.



Fraunhofer Institut
Integrierte Schaltungen

MPEG Layer-3 audio coding technology licensed from Fraunhofer IIS and Thomson.



This receiver supports network connections.



“HDMI”, the “HDMI” logo, and “High-Definition Multimedia Interface” are trademarks or registered trademarks of HDMI Licensing LLC.

SILENT™
CINEMA

“SILENT CINEMA” is a trademark of YAMAHA CORPORATION.



The XM name and related logos are registered trademarks of XM Satellite Radio Inc.



This product is manufactured under license from Neural Audio Corporation and THX Ltd. YAMAHA CORPORATION hereby grants the user a non-exclusive, non-transferable, limited right of use to this product under U.S.A. and foreign patent, patent pending and other technology or trademarks owned by Neural Audio Corporation and THX Ltd. “Neural Surround”, “Neural Audio”, “Neural” and “NRL” are trademarks and logos owned by Neural Audio Corporation. THX is a trademark of THX Ltd., which may be registered in some jurisdictions. All rights reserved.

Windows XP, Windows Vista, Windows Media Audio, Windows Media Connect and Windows Media Player are either registered trademarks or trademarks of Microsoft corporation in the United States and/or other countries.

Features

Built-in 7-channel power amplifier

- ◆ Minimum RMS output power (20 Hz to 20 kHz, 0.04% THD, 8 Ω)
Front: 140 W + 140 W
Center: 140 W
Surround: 140 W + 140 W
Surround back: 140 W + 140 W

Sound field programs

- ◆ Proprietary Yamaha technology for the creation of sound fields
- ◆ CINEMA DSP 3D mode for creating intensive and accurate stereoscopic sound field
- ◆ Compressed Music Enhancer mode to improve the sound quality of compression artifacts (such as the MP3 format) to that of a high-quality multi-channel source playback
- ◆ Virtual CINEMA DSP
- ◆ SILENT CINEMA

Digital audio decoders

- ◆ Dolby TrueHD, Dolby Digital Plus decoder
- ◆ DTS-HD Master Audio, DTS-HD High Resolution Audio decoder
- ◆ Dolby Digital/Dolby Digital EX decoder
- ◆ DTS/DTS-ES Matrix 6.1, Discrete 6.1, DTS 96/24 decoder
- ◆ Dolby Pro Logic/Dolby Pro Logic II/Dolby Pro Logic IIX decoder
- ◆ DTS NEO:6 decoder
- ◆ Neural-THX Surround decoder (U.S.A. and Canada models only)

Sophisticated FM/AM tuner

- ◆ 40-station random and direct preset tuning
- ◆ Automatic preset tuning
- ◆ Preset station shifting capability (preset editing)

XM™ Satellite Radio

- ◆ XM Satellite Radio tuning capability (using XM Mini-Tuner and Home Dock, sold separately)
- ◆ Neural-THX Surround decoder to play back the XM HD content of XM Satellite Radio broadcasts in multi-channels, resulting in a full surround sound experience
- ◆ XM Satellite Radio information displaying capability

HDMI™ (High-Definition Multimedia Interface)

- ◆ HDMI interface for standard, enhanced or high-definition video as well as multi-channel digital audio based on HDMI version 1.3a
- ◆ Automatic audio and video synchronization (lip sync) information capability
- ◆ Deep Color video signal (30/36 bits) transmission capability
- ◆ High refresh rate and high resolution video signals capability
- ◆ High definition digital audio format signals capability
- ◆ Analog video to HDMI digital video up-conversion (composite video ↔ S-video ↔ component video → HDMI digital video) capability for monitor out
- ◆ Analog video up-scaling from 480i (NTSC)/576i (PAL) or 480p/576p to 720p, 1080i or 1080p

iPod controlling capability

- ◆ DOCK terminal to connect a Yamaha iPod universal dock (such as the YDS-10, sold separately), which supports iPod (Click and Wheel), iPod nano, and iPod mini

Network features

- ◆ NETWORK port to connect a PC and Yamaha MCX-2000 or access the Internet Radio via LAN
- ◆ DHCP automatic or manual network configuration

USB features

- ◆ USB port to connect a USB memory device or a USB portable audio player

Other features

- ◆ YPAO (Yamaha Parametric Room Acoustic Optimizer) for automatic speaker setup
- ◆ 192-kHz/24-bit D/A converter
- ◆ GUI (graphical user interface) menus that allow you to optimize this unit to suit your individual audio/video system
- ◆ GUI display menu language switching capability (English, Japanese, French, German, Spanish and Russian)
- ◆ 6 or 8-channel additional input jacks for discrete multi-channel input
- ◆ Analog video interlace/progressive conversion from 480i (NTSC)/576i (PAL) to 480p/576p
- ◆ S-video signal input/output capability
- ◆ Component video input/output capability includes (3 COMPONENT VIDEO INs and 1 MONITOR OUT)
- ◆ Optical and coaxial digital audio signal jacks
- ◆ Pure Direct mode for pure hi-fi sound for all sources
- ◆ Adaptive dynamic range controlling capability
- ◆ Adaptive DSP effect level controlling capability
- ◆ Remote control with preset remote control codes, learning, macro and buttons and display backlight capability
- ◆ ZONE 2/ZONE 3 custom installation facility
- ◆ Zone switching capability between the main zone and ZONE 2/ZONE 3 using ZONE CONTROLS
- ◆ Zone 2 video output and displaying OSD (on-screen display) capability
- ◆ System Memory capability for saving and recalling multiple system parameter settings
- ◆ Sleep timer

Supplied accessories

Check that you received all of the following parts.

Remote control

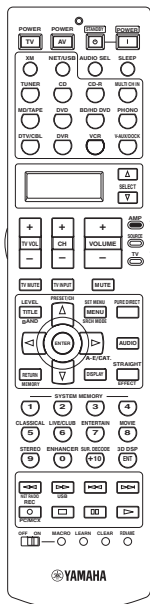

Zone 2/Zone 3 remote control

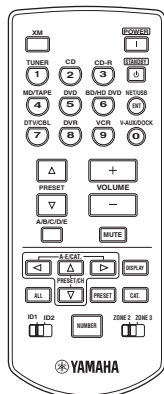

Batteries (6) (AAA, LR03)

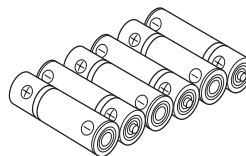

Speaker terminal wrench

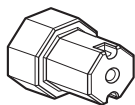

Power cable (Two for Asia model)

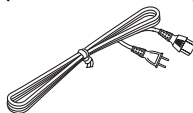

Optimizer microphone

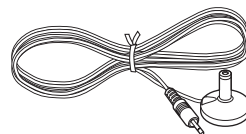

Indoor FM antenna

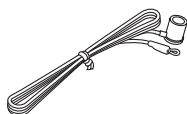

AM loop antenna

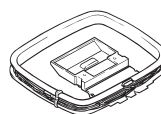

Note

The form of the supplied accessories varies depending on the models.

Getting started

■ Installing batteries in the remote control

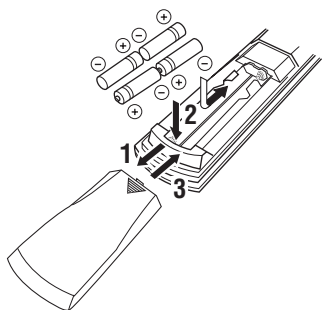

1 Press the ▼ part and slide the battery compartment cover off.

2 Insert the four supplied batteries (AAA, LR03) according to the polarity markings (+ and -) on the inside of the battery compartment.

3 Slide the cover back until it snaps into place.

■ Installing batteries in the Zone 2/Zone 3 remote control

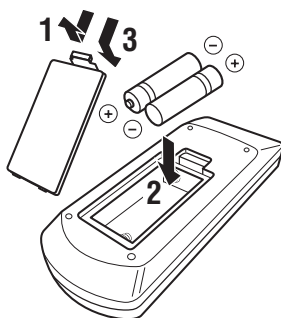

1 Take off the battery compartment cover.

2 Insert the two supplied batteries (AAA, LR03) according to the polarity markings (+ and -) on the inside of the battery compartment.

3 Snap the battery compartment cover back into place.

Notes

- Change all of the batteries if you notice the following conditions:
 - the operation range of the remote control decreases.
 - the transmit indicator (⊗) does not flash or its light becomes dim.
- Do not use old batteries together with new ones.
- Do not use different types of batteries (such as alkaline and manganese batteries) together. Read the packaging carefully as these different types of batteries may have the same shape and color.
- We strongly recommend that you use alkaline batteries.
- If the batteries have leaked, dispose of them immediately. Avoid touching the leaked material or letting it come into contact with clothing, etc. Clean the battery compartment thoroughly before installing new batteries.
- Do not throw away batteries with general house waste; dispose of them correctly in accordance with your local regulations.
- If the remote control is without batteries for more than 2 minutes, or if exhausted batteries remain in the remote control, the contents of the memory may be cleared. When the memory is cleared, insert new batteries, set up the remote control code and program any acquired functions that may have been cleared.

■ VOLTAGE SELECTOR (Asia and General models only)

Caution

The VOLTAGE SELECTOR on the rear panel of this unit must be set for your local voltage BEFORE plugging the power cable into the AC wall outlet. Improper setting of the VOLTAGE SELECTOR may cause damage to this unit and create a potential fire hazard.

Rotate the VOLTAGE SELECTOR clockwise or counterclockwise to the correct position using a straight slot screwdriver.

Voltages are as follows:

.....AC 110/120/220/230–240 V, 50/60 Hz

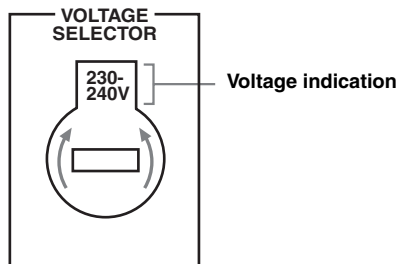

Quick start guide

The following steps describe the easiest way to enjoy DVD movie playback in your home theater.

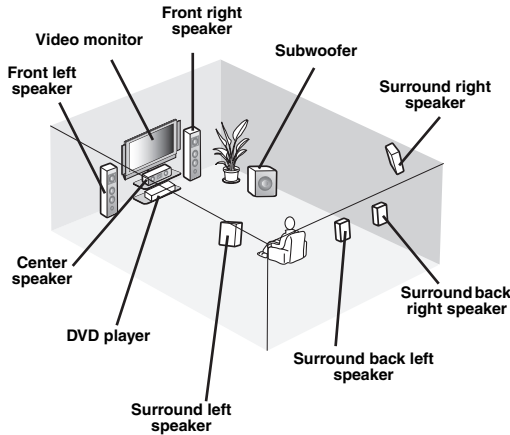

Step 1: Set up your speakers

P. 7

Step 2: Connect your DVD player and other components

P. 8

Step 3: Turn on the power and start playback

P. 10

Enjoy DVD playback!

Preparation: Check the items

In these steps, you need the following supplied accessories.

- AM loop antenna
- Indoor FM antenna
- Power cable

The following items are not included in the package of this unit.

- Speakers**
 - Front speaker x 2
 - Center speaker x 1
 - Surround speaker x 4

Select magnetically shielded speakers. The minimum required speakers are two front speakers. The priority of the requirement of other speakers is as follows:

 1. Two surround speakers
 2. One center speaker
 3. One (or two) surround back speaker(s)
- Active subwoofer** x 1
Select an active subwoofer equipped with an RCA input jack.
- Speaker cable** x 7
- Subwoofer cable** x 1
Select a monaural RCA cable.
- DVD player** x 1
Select DVD player equipped with coaxial digital audio output jack and composite video output jack.
- Video monitor** x 1
Select a TV monitor, video monitor or projector equipped with a composite video input jack.
- Video cable** x 2
Select an RCA composite video cables.
- Digital coaxial audio cable** x 1

Step 1: Set up your speakers

Place your speakers in the room and connect them to this unit.

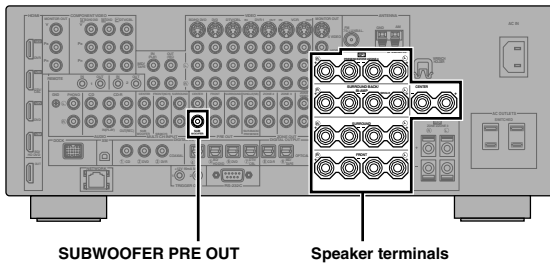

1 Place your speakers and subwoofer in the room.

2 Connect speaker cables to each speaker.

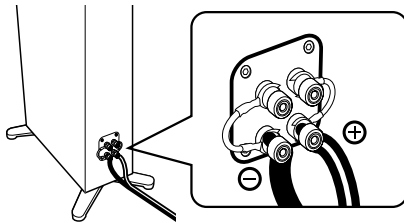

3 Connect each speaker cable to the corresponding speaker terminal of this unit.

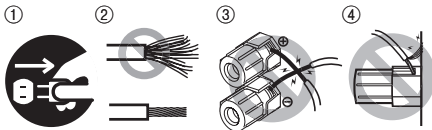

- 1 Make sure that this unit and the subwoofer are unplugged from the AC wall outlets.
- 2 Twist the exposed wires of the speaker cables together to prevent short circuits.
- 3 Do not let the bare speaker wires touch each other.
- 4 Do not let the bare speaker wires touch any metal part of this unit.

Be sure to connect the left channel (L), right channel (R), “+” (red) and “-” (black) properly.

Front speakers and center speaker

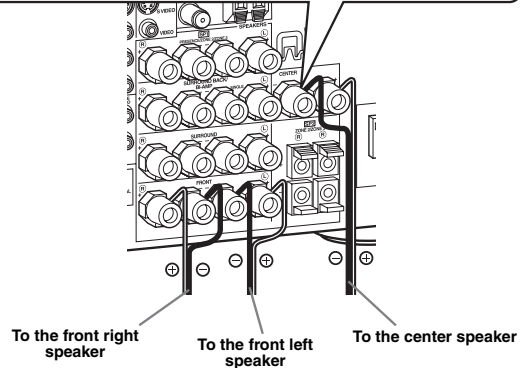
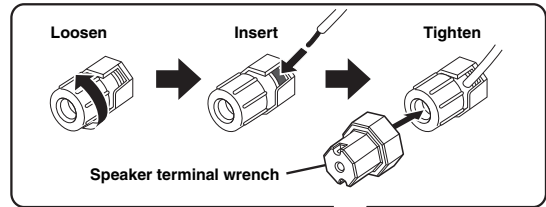

Surround and surround back speakers

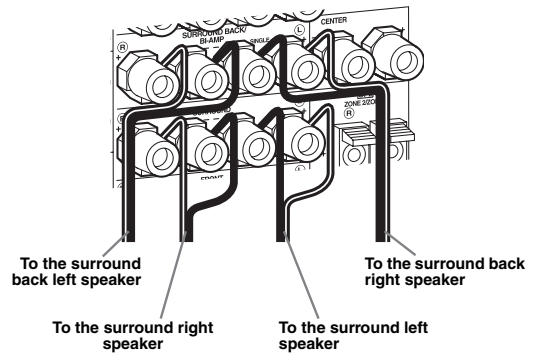

4 Connect the subwoofer cable to the **SUBWOOFER PRE OUT** jack of this unit and the input jack of the subwoofer.

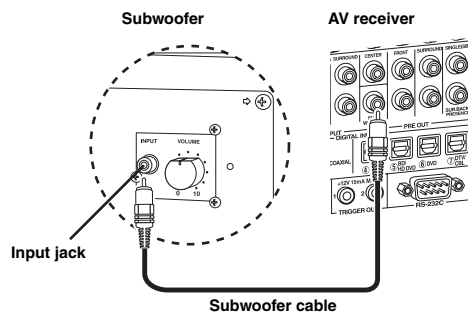

Step 2: Connect your DVD player and other components

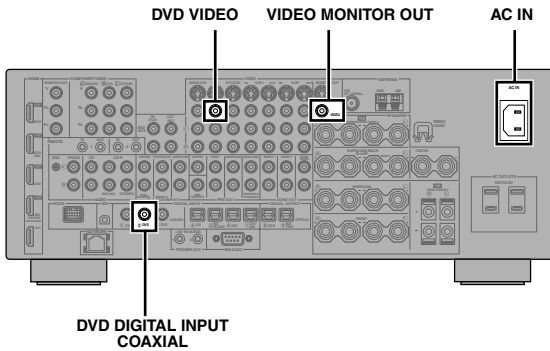

Make sure that this unit and the DVD player are unplugged from the AC wall outlets.

- 1 Connect the digital coaxial audio cable to the digital coaxial audio output jack of your DVD player and the DVD DIGITAL INPUT COAXIAL jack of this unit.

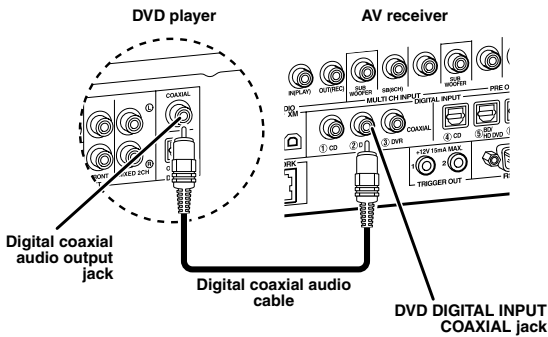

- 2 Connect the video cable to the composite video output jack of your DVD player and the DVD VIDEO jack of this unit.

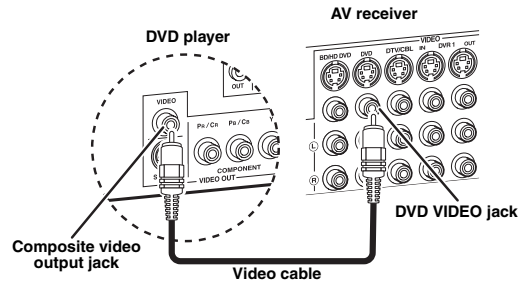

- 3 Connect the video cable to the VIDEO MONITOR OUT jack of this unit and the video input jack of your video monitor.

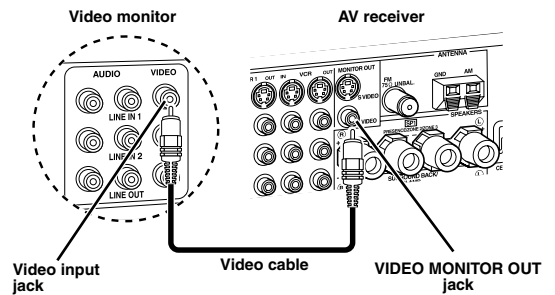

4 Connect the supplied AM loop antenna and indoor FM antenna to this unit.

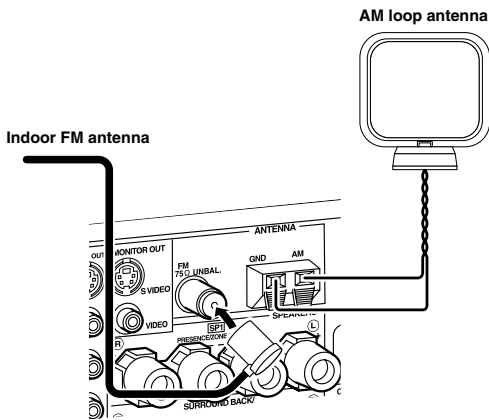

Note

The types of the supplied indoor FM antenna and the FM antenna terminal of this unit are different depending on the models.

Connecting the wire of the AM loop antenna

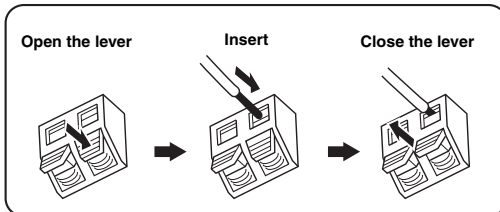

The wire of the AM loop antenna does not have any polarity and you can connect either end of the wire to AM or GND terminal.

Assembling the supplied AM loop antenna

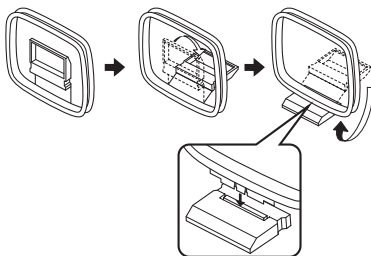

5 Connect the supplied power cable to AC IN of this unit and then plug the power cable and other components into the AC wall outlet.



- This unit is equipped with AC OUTLET(S) that provide(s) power to other components (except Korea model). See page 32 for details.
- (Asia model only) Select one of the supplied power cables suitable for the type of AC wall outlet in your location before plugging this into the AC wall outlet.

For further connections

- Using other kinds of speaker combinations P. 13
- Connecting a video monitor via various ways of connection P. 23
- Connecting a DVD player via various ways of connection P. 25
- Connecting a DVD recorder or a digital video recorder P. 26
- Connecting a set-top box P. 26
- Connecting a CD player, an MD recorder, or a turntable P. 27
- Connecting an external amplifier P. 28
- Connecting a DVD player via multi-channel analog audio connection P. 29
- Connecting a Yamaha iPod universal dock P. 30
- Using the REMOTE IN/OUT jacks P. 30
- Using the VIDEO AUX jacks on the front panel P. 30
- Connecting FM/AM antennas P. 32
- Connecting XM Mini-Tuner Home Dock P. 56
- Connecting this unit to your network P. 31
- Connecting a USB device P. 68

General connection information

- General information on jacks and cable plugs P. 20
- General information on HDMI P. 21
- Speaker impedance settings P. 33

Step 3: Turn on the power and start playback

Check the type of the connected speakers.
If the speakers are 6-ohm speakers, set "SPEAKER IMP." to "6Ω MIN" before using this unit (see page 122). You can also use 4-ohm speakers as the front speakers (see page 33).

1 Turn on the video monitor connected to this unit.

2 Press **(A) MASTER ON/OFF inward to the ON position on the front panel.**

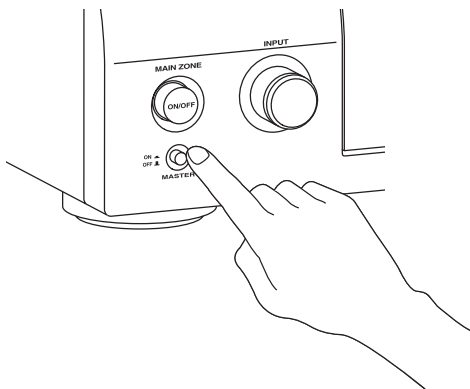

3 Rotate the **(C) INPUT selector to set the input source to "DVD".**



- The recommended sound field program is set for each input source (DVD, etc.). You can also use various sound field programs and other sound modes for playback. Refer to the following pages for details:
 - see pages 50 and 71 to use various sound field programs
 - see page 50 to turn on or off the sound effect
 - see page 51 to use the pure direct mode for high fidelity sound
- You can also set the input source to "TUNER" to use the FM/AM tuning feature. For information on the FM/AM tuning, see pages 53 to 55.

4 Start playback of the desired DVD on your player.

5 Rotate **(B) VOLUME to adjust the volume.**

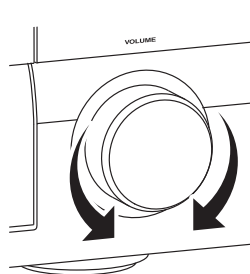

■ **After using this unit...**



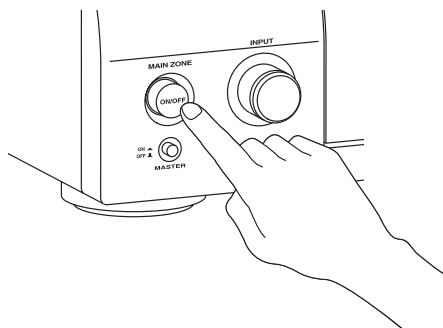



Press **(B) MAIN ZONE ON/OFF to set this unit to the standby mode.**







This unit is set to the standby mode and consumes a small amount of power in order to receive infrared signals from the remote control. To turn on this unit from the standby mode, press **(B)** MAIN ZONE ON/OFF on the front panel (or **(P)** POWER on the remote control). See page 33 for details.

What do you want to do with this unit?



Using various input sources

- Basic operations of this unit  P. 41
- Enjoying FM/AM radio programs  P. 53
- Enjoying XM Satellite Radio programs  P. 56
- Using your iPod with this unit  P. 62
- Enjoying the contents stored on your PC  P. 64
- Enjoying Internet radio programs and Podcasts  P. 67
- Using USB devices with this unit  P. 68





Using various sound features

- Using various sound field programs  P. 45
- Using the Pure Direct mode for high fidelity sound  P. 51
- Adjusting the tonal quality of the speakers  P. 51
- Customizing the sound field programs  P. 74













Adjusting the parameters of this unit

- Automatically optimizing the speaker parameters for your listening room (Auto Setup)  P. 37
- Setting the remote control  P. 105





Additional features

- Displaying the current input source signal information in the GUI  P. 98
- Saving and recalling the system settings of this unit (System Memory)  P. 100
- Using headphones  P. 42
- Using this unit in multiple rooms simultaneously (multi-zone configuration)  P. 117
- Automatically turning off this unit  P. 43

Manually adjusting various parameters of this unit

- Setting the language of the GUI menu  P. 99
- Assigning the input/output jacks of this unit  P. 82
- Setting the parameters for each input source  P. 81
- Setting the parameters related to the volume level  P. 84
- Adjusting the tonal quality of each channel manually by using the parametric equalizer  P. 85
- Adjusting the audio and video synchronization  P. 87
- Muting the selected speaker channel  P. 88
- Setting the parameters related to the video signals  P. 89
- Setting the basic speaker configuration  P. 91
- Setting the network parameters  P. 94
- Setting the parameters of the multi-zone feature  P. 96
- Protecting the various settings  P. 98

Adjusting the advanced parameters

- Setting the speaker impedance of the connected speakers  P. 122
- Setting the language of the GUI menu  P. 126
- Setting the video format of the connected video monitor  P. 126
- Setting the parameters of this unit to default values  P. 137

Connections

Rear panel

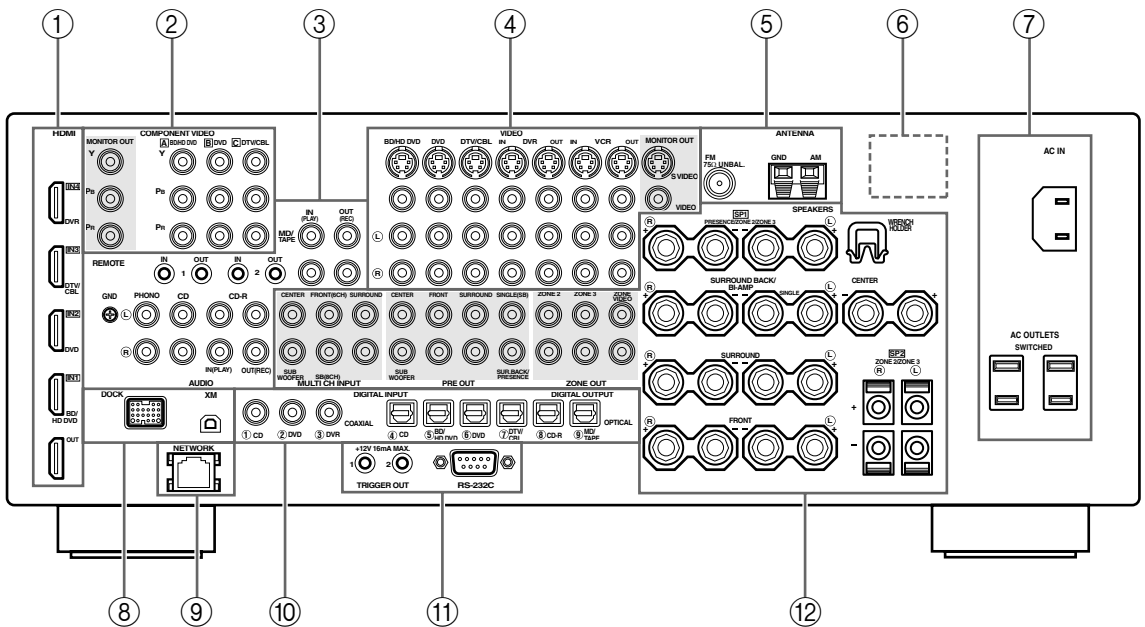

	Name	Page
①	HDMI connectors	21
②	COMPONENT VIDEO jacks	23 – 26
③	Audio component jacks	27
	REMOTE IN/OUT jacks	30
④	Video component jacks	23 – 26
⑤	ANTENNA terminals	32
⑥	VOLTAGE SELECTOR (Asia and General models only)	32
⑦	AC IN	32
	AC OUTLET(S)	32
⑧	DOCK terminal	30
	XM jack (U.S.A. and Canada models only)	56
⑨	NETWORK port	31
⑩	DIGITAL INPUT/OUTPUT jacks	24
⑫	MULTI CH INPUT jacks	29
	PRE OUT jacks	28
	ZONE OUT jacks	117
	Speaker terminals	15
	WRENCH HOLDER	18

⑪ TRIGGER OUT jack

This is a control expansion terminal for custom installation. Consult your dealer for details.

⑫ RS-232C terminal

This is a control expansion terminal for factory use only. Consult your dealer for details.

Placing speakers

The speaker layout below shows the speaker setting we recommend. You can use it to enjoy the CINEMA DSP and multi-channel audio sources.

7.1-channel speaker layout

7.1-channel speaker layout is highly recommended for playback the sound of high definition audio formats (Dolby TrueHD, DTS-HD Master Audio, etc.) as well as the conventional audio sources with sound field programs. See page 15 for connection information.



We recommend that you also add the presence speakers for the effect sounds of the CINEMA DSP sound field program. See page 17 for details.

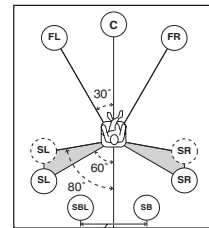
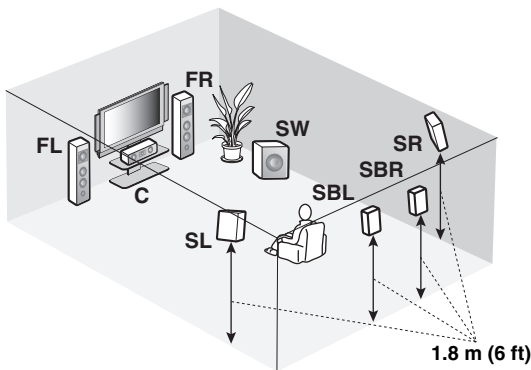

30 cm (12 in) or more

Speaker indications

FL/FR: Front left/right

C: Center

SL/SR: Surround left/right

SBL/SBR: Surround back left/right

SW: Subwoofer

Front left and right speakers

The front speakers are used for the main source sound plus effect sounds. Place these speakers at an equal distance from the ideal listening position. The distance of each speaker from each side of the video monitor should be the same.

Center speaker

The center speaker is for the center channel sounds (dialog, vocals, etc.). If for some reason it is not practical to use a center speaker, you can do without it. Best results, however, are obtained with the full system.

Surround left and right speakers

The surround speakers are used for effect and surround sounds.

Surround back left and right speakers

The surround back speakers supplement the surround speakers and provide more realistic front-to-back transitions.

Subwoofer

The use of a subwoofer with a built-in amplifier, such as the Yamaha Active Servo Processing Subwoofer System, is effective not only for reinforcing bass frequencies from any or all channels, but also for reproducing the high fidelity sound of the LFE (low-frequency effect) channel included in Dolby Digital and DTS sources. The position of the subwoofer is not so critical, because low bass sounds are not highly directional. But it is better to place the subwoofer near the front speakers. Turn it slightly toward the center of the room to reduce wall reflections.

■ 6.1-channel speaker layout

See page 15 for connection information.



We recommend that you also add the presence speakers for the effect sounds of the CINEMA DSP sound field program. See page 17 for details.

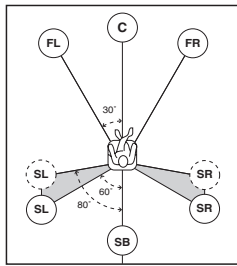
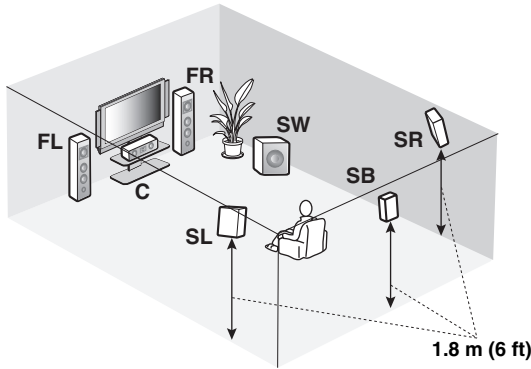

Speaker indications

FL/FR: Front left/right
C: Center
SL/SR: Surround left/right
SB: Surround back left/right
SW: Subwoofer

■ 5.1-channel speaker layout

See page 15 for connection information.



We recommend that you also add the presence speakers for the effect sounds of the CINEMA DSP sound field program. See page 17 for details.

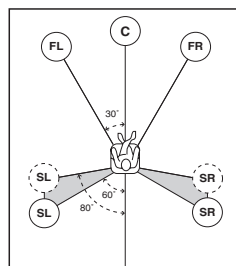
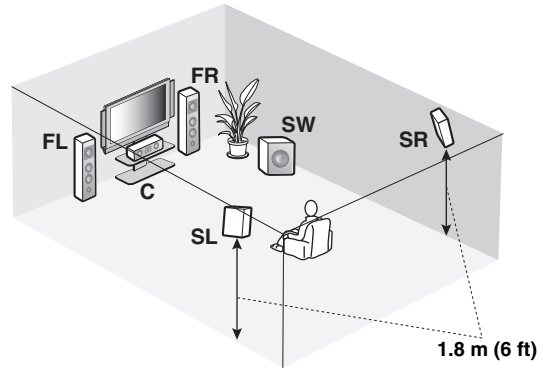

Speaker indications

FL/FR: Front left/right
C: Center
SL/SR: Surround left/right
SW: Subwoofer

Front left and right speakers

Center speaker

Surround left and right speakers

Subwoofer

The functions and settings of each speaker are the same as those for the 7.1-channel speaker layout (see page 13).

Surround back speaker

Connect a single surround speakers to the SURROUND BACK SINGLE speaker terminal and place the single surround back speaker behind the listening position. The surround back left and right channel signals are mixed down and output at the single surround back speaker when you set “Surround Back” to “Small x1” or “Large x1” (see page 92).

Front left and right speakers

Center speaker

Subwoofer

The functions and settings of each speaker are the same as those for the 7.1-channel speaker layout (see page 13).

Surround left and right speakers

Connect the surround speakers to the SURROUND speaker terminals even if you place the surround speakers behind the listening position. For the smooth and unbroken sound field behind the listening position, place the surround left and right speakers farther back compared with the placement in the 7.1-channel speaker layout. The surround back channel signals are directed to the surround left and right speakers when “Surround Back” is set to “None” (see page 92).

For other speaker combinations

You can enjoy multi-channel sources with sound field programs by using a speaker combination other than the 7.1/6.1/5.1-channel speaker combinations.

Use the automatic setup feature (see page 37) or set the “Speaker Set” parameters in “Manual Setup” (see page 91) to output the surround sounds at the connected speakers.

Connecting speakers

Be sure to connect the left channel (L), right channel (R), “+” (red) and “-” (black) properly. If the connections are faulty, this unit cannot reproduce the input sources accurately.

Caution

- Before connecting the speakers, make sure that this unit is turned off (see page 33).
- Do not let the bare speaker wires touch each other or do not let them touch any metal part of this unit. This could damage this unit and/or speakers.
- Use magnetically shielded speakers. If this type of speaker still creates interference with the monitor, place the speakers away from the monitor.
- If you are to use 6-ohm speakers, be sure to set “SPEAKER IMP.” to “6ΩMIN” before using this unit (see page 33). You can also use 4-ohm speakers as the front speakers (see page 122).

Notes

- A speaker cord is actually a pair of insulated cables running side by side. Cables are colored or shaped differently, perhaps with a stripe, groove or ridge. Connect the striped (grooved, etc.) cable to the “+” (red) terminals of this unit and your speaker. Connect the plain cable to the “-” (black) terminals.
- You can use the SP1 terminals to connect the Zone 2 or Zone 3 speakers as well as the presence speakers (see page 118).

■ For the 7.1-channel speaker setting

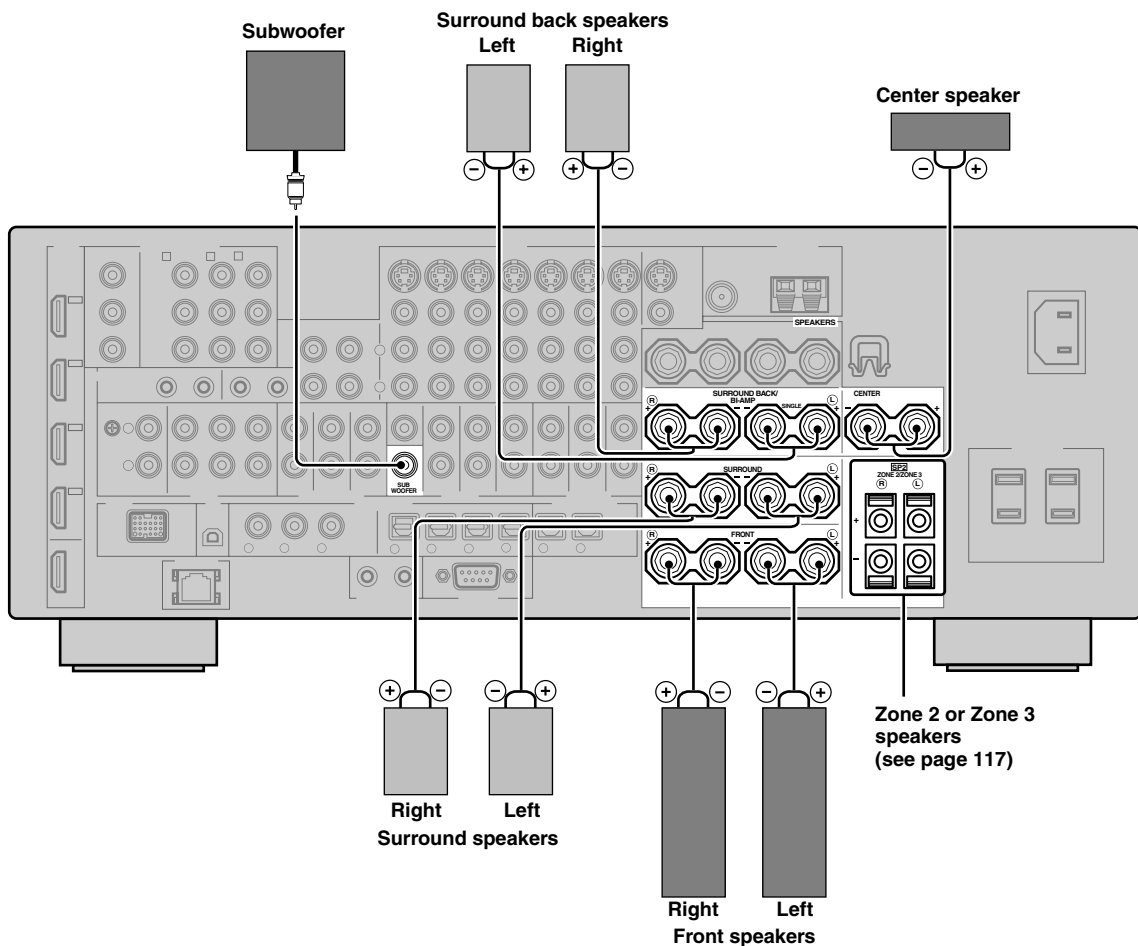

■ For the 6.1-channel speaker setting

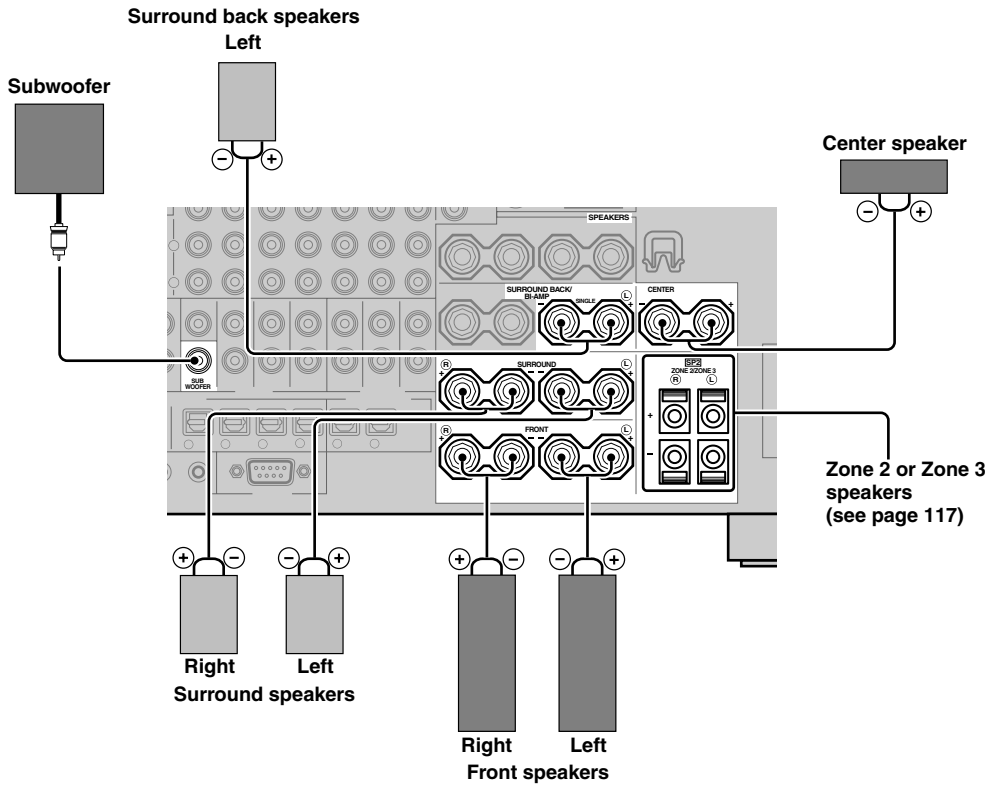

■ For the 5.1-channel speaker setting

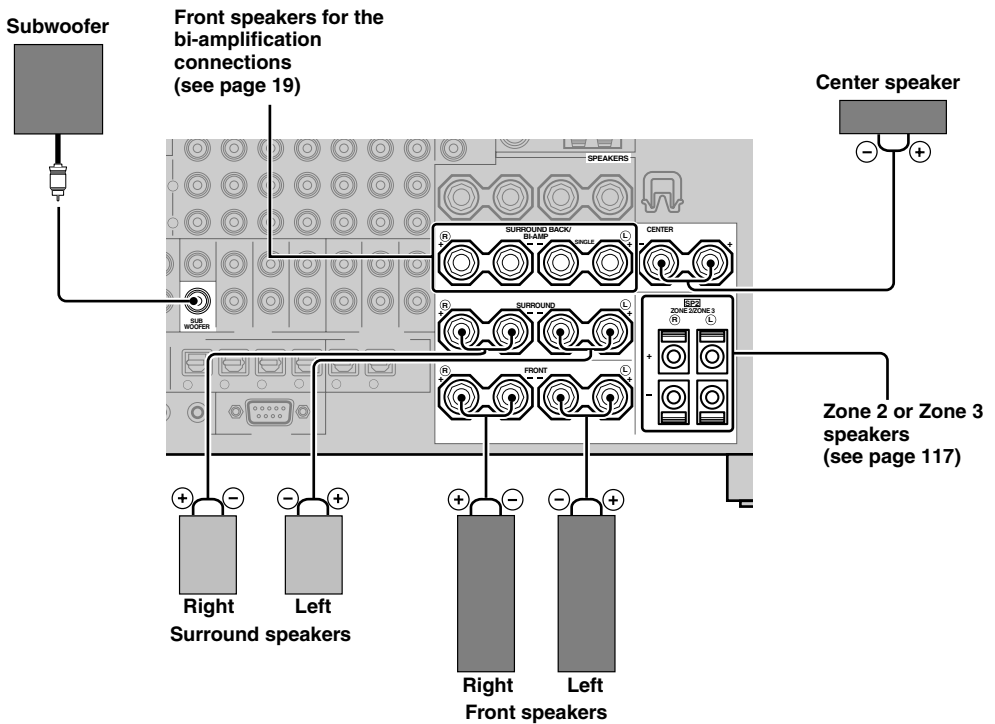

Using presence speakers

The presence speakers supplement the sound from the front speakers with extra ambient effects produced by the sound field programs (see page 45). Presence left and right speakers function more effectively when the CINEMA DSP 3D mode is active (see page 50). You can adjust the vertical position of dialogues with using the presence speakers (see page 75). To use the presence speakers, connect the speakers to SP1 speaker terminals and then set “Presence” to “Yes” (see page 92).

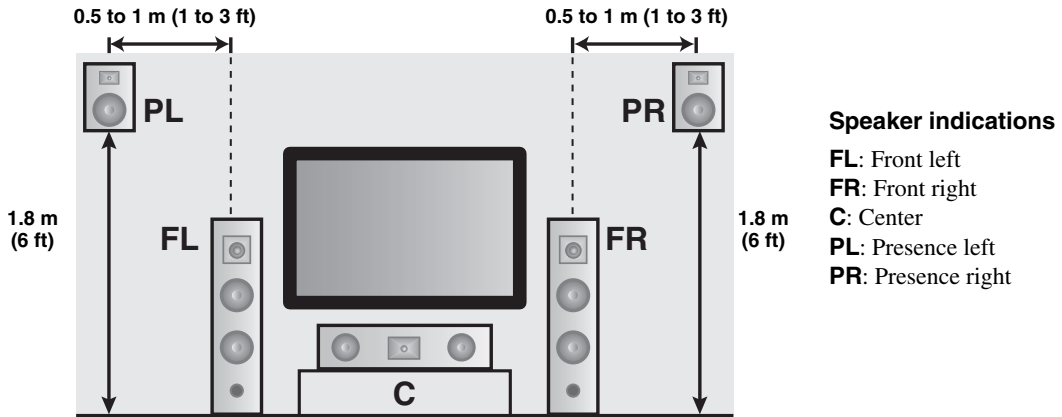

Notes

- If “Presence” is set to “None”, this unit cannot activate the CINEMA DSP 3D mode.
- You can connect both surround back and presence speakers to this unit, but they do not output sound simultaneously. This unit automatically switches the presence speakers and surround back speakers depending on the input sources and the selected sound field programs. You can set to prioritize either set of speakers using the “PR/SB Priority” parameter in “Basic” (see page 93).

■ Connecting presence left and right speakers

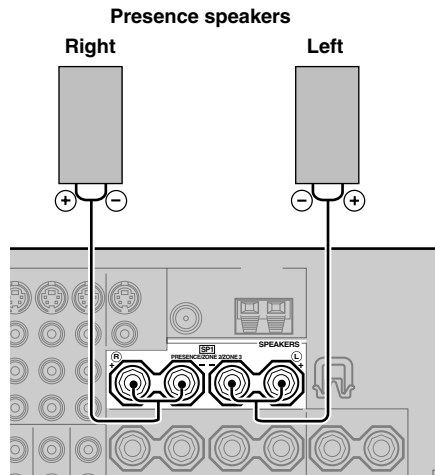

■ Connecting the speaker cable

- 1 Remove approximately 10 mm (0.4 in) of insulation from the end of each speaker cable and then twist the exposed wires of the cable together to prevent short circuits.

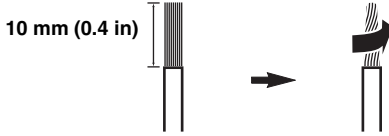

- 2 Loosen the knob using the supplied speaker terminal wrench.

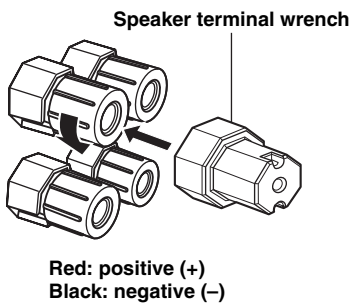

- 3 Insert one bare wire into the hole on the side of each terminal.

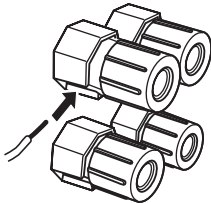

- 4 Tighten the knob to secure the wire using the supplied speaker terminal wrench.

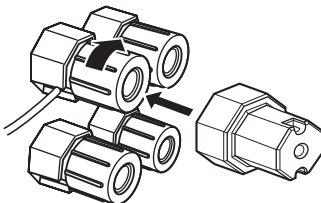

- 5 Hook the speaker terminal wrench onto the WRENCH HOLDER on the rear panel of this unit when not in use.

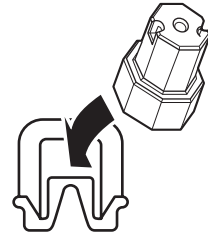

■ Connecting to the SP2 speaker terminals

Connect Zone 2 or Zone 3 speakers to these terminals (see page 117).

- 1 Open the tab.

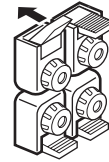

Red: positive (+)
Black: negative (-)

- 2 Insert one bare wire into the hole on the terminal.

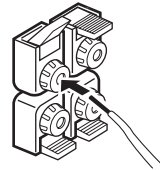

- 3 Close the tab to secure the wire.

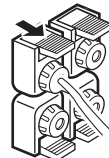

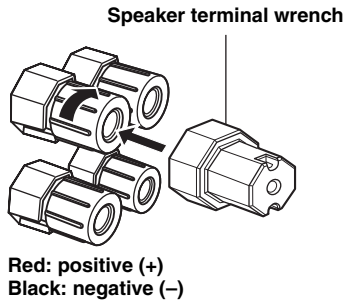

■ Connecting the banana plug (except U.K., Europe, Asia and Korea models)

1 Tighten the knob using the supplied speaker terminal wrench.

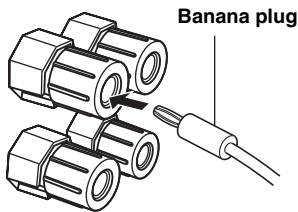

2 Insert the banana plug connector into the end of the corresponding terminal.



 You can also use the banana plug with the SP2 speaker terminals. Open the tab and then insert one banana plug into the hole on the terminal. Do not close the tab after connecting the banana plug.

■ Using bi-amplification connections

Caution

Remove the shorting bars or bridges of your speakers to separate the LPF (low pass filter) and HPF (high pass filter) crossovers.

This unit allows you to make bi-amplification connections to one speaker system. Check if your speakers support bi-amplification.

To make the bi-amplification connections, use the FRONT and SURROUND BACK/BI-AMP terminals as shown below. To activate the bi-amplification connections, set "BI-AMP" to "ON" in "ADVANCED SETUP" (see page 126).

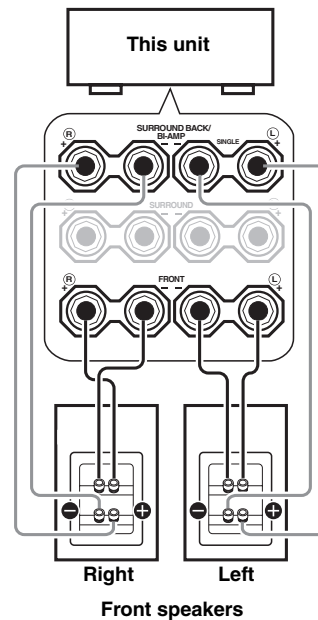

Note

When you make the conventional connection, make sure that the shorting bars are put into the terminals of the speakers appropriately. Refer to the instruction manuals of the speakers for details.

Information on jacks and cable plugs

Audio jacks and cable plugs

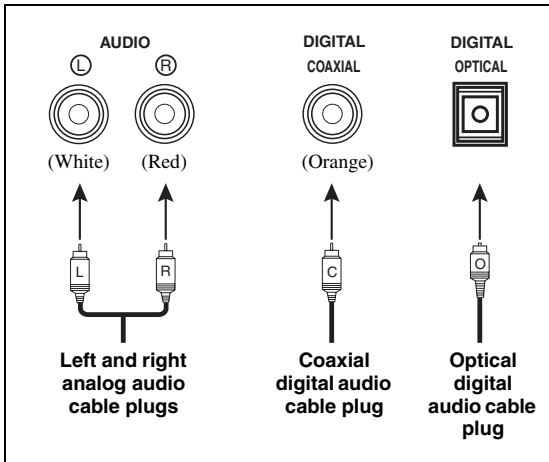

Video jacks and cable plugs

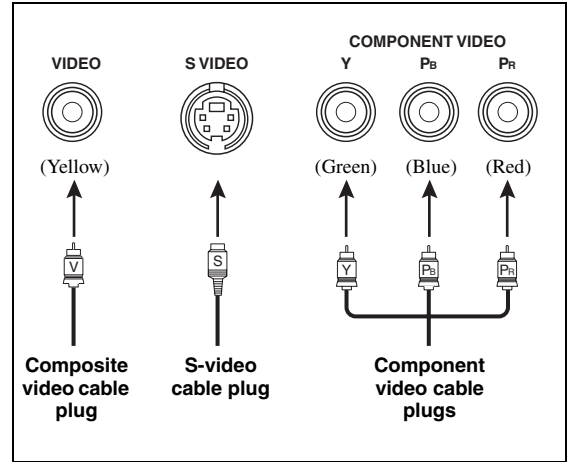

■ Audio jacks

This unit has three types of audio jacks. Connection depends on the availability of audio jacks on your other components.

AUDIO jacks

For conventional analog audio signals transmitted via left and right analog audio cables. Connect red plugs to the right jacks and white plugs to the left jacks.

DIGITAL COAXIAL jacks

For digital audio signals transmitted via coaxial digital audio cables.

DIGITAL OPTICAL jacks

For digital audio signals transmitted via optical digital audio cables.

Note

You can use the digital jacks to input PCM, Dolby Digital and DTS bitstreams. When you connect components to both the COAXIAL and OPTICAL jacks, priority is given to the signals input at the COAXIAL jack. All digital input jacks are compatible with 96-kHz sampling digital signals.

■ Video jacks

This unit has three types of video jacks. Connect the video input jacks of this unit to the video output jacks of the input source components to switch the audio and video sources simultaneously. Connection depends on the availability of input jacks on your video monitor.

VIDEO jacks

For conventional composite video signals transmitted via composite video cables.

S VIDEO jacks

For S-video signals, separated into the luminance (Y) and chrominance (C) video signals transmitted on separate wires of S-video cables.

COMPONENT VIDEO jacks

For component video signals, separated into the luminance (Y) and chrominance (P_B, P_R) video signals transmitted on separate wires of component video cables.



This unit is equipped with the video conversion function. See pages 22 and 89 for details.

Information on HDMI™

This unit has four HDMI input jacks and one HDMI output jack for digital audio and video signal input/output. Connect the HDMI IN1, HDMI IN2, HDMI IN3, or HDMI IN4 jack of this unit to the HDMI output jack of other HDMI components (such as a DVD player). Connect the HDMI OUT jack of this unit to the HDMI input jack of other HDMI components (such as a TV and a projector).

The video or audio signals input at the HDMI IN jacks of the selected input source are output at the HDMI OUT jack of this unit.



- You can check the potential problem about the HDMI connection (see page 98).
- See page 145 for the information on the input signal capability of this unit for the HDMI connection.

■ HDMI jack and cable plug

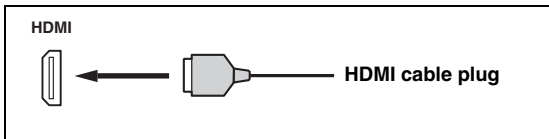

- We recommend that you use a commercially available HDMI cable shorter than 5 meters (16 feet) with the HDMI logo printed on it.
- Use a conversion cable (HDMI jack ↔ DVI-D jack) to connect this unit to other DVI components.

Notes

- Do not disconnect or connect the cable or turn off the power of the HDMI components connected to the HDMI OUT jack of this unit while data is being transferred. Doing so may disrupt playback or cause noise.
- The HDMI OUT jack outputs the audio signals input at the HDMI input jacks only even if “Support Audio” is set to “Other” (see page 98).
- If you turn off the power of the video monitor connected to the HDMI OUT jack via a DVI connection, this unit may fail to establish the connection to the component.
- The analog video signals input at the composite video, S-video and component video jacks can be digitally up-converted to be output at the HDMI OUT jack. Set “Conversion” to “On” in “Manual Setup” (see page 89) to activate this feature.

■ Default input assignment of HDMI input jacks

HDMI input jack	Assigned input source
IN1	BD/HD DVD
IN2	DVD
IN3	DTV/CBL
IN4	DVR

Audio and video signal flow

Audio signal flow

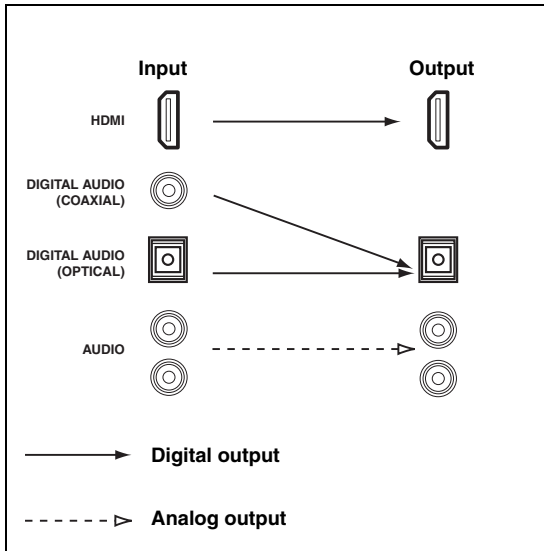

Notes

- 2-channel as well as multi-channel PCM, Dolby Digital and DTS signals input at the HDMI input jacks can be output at the HDMI OUT jack only when "Support Audio" is set to "Other" (see page 98).
- The following types of audio signals can be only input at HDMI input jacks:
 - DSD
 - Dolby TrueHD
 - Dolby Digital Plus
 - DTS-HD Master Audio
 - DTS-HD High Resolution Audio

Video signal flow

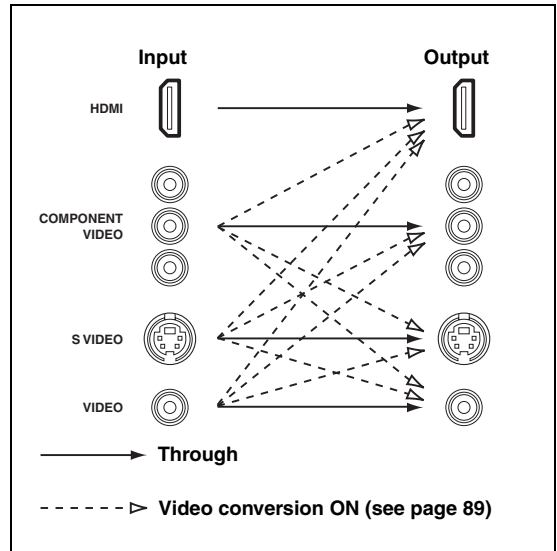

You can deinterlace and convert the resolution of the video signals by using "Video" parameters. See page 89 for details.

Notes

- When the analog video signals are input at the COMPONENT VIDEO, S VIDEO and VIDEO jacks, the priority order of the input signals is as follows:
 1. COMPONENT VIDEO
 2. S VIDEO
 3. VIDEO
- Digital video signals input at the HDMI input jacks cannot be output from analog video output jacks.
- The analog component video signals (with 480i (NTSC)/576i (PAL) of resolution only) are converted to the S-video or composite video signals and output at the VIDEO or S VIDEO MONITOR OUT jacks.
- The analog component video signals with 1080p of resolution are only output at the COMPONENT VIDEO MONITOR OUT jacks.
- The GUI signal is not output at the DVR OUT and VCR OUT jacks and is not recorded.

Connecting a TV monitor or projector

Connect your TV (or projector) to the HDMI OUT jack, the COMPONENT VIDEO MONITOR OUT jacks, the S VIDEO MONITOR OUT jack or the VIDEO MONITOR OUT jack of this unit.



Make sure that this unit and other components are unplugged from the AC wall outlets.



You can select to play back HDMI audio signals on this unit or on another HDMI component connected to the HDMI OUT jack on the rear panel of this unit. Use the “Support Audio” parameter in “Option” to select the component to play back HDMI audio signals (see page 98).

Notes

- Some video monitors connected to this unit via a DVI connection fail to recognize the HDMI audio/video signals being input if they are in the standby mode. In this case, the HDMI indicator flashes irregularly.
- Set “Conversion” in “Video” to “On” (see page 89) to display the short message displays.
- The GUI screen appears with the wall paper or gray background depending on the input video signal format and the setting of the parameters in “Wall Paper” (see page 91).
- If the connected video monitor is compatible with the automatic audio and video synchronization feature (automatic lip sync feature), this unit adjusts the audio and video timing automatically (see page 87). Connect the video monitor to the HDMI OUT jack of this unit to use the feature.

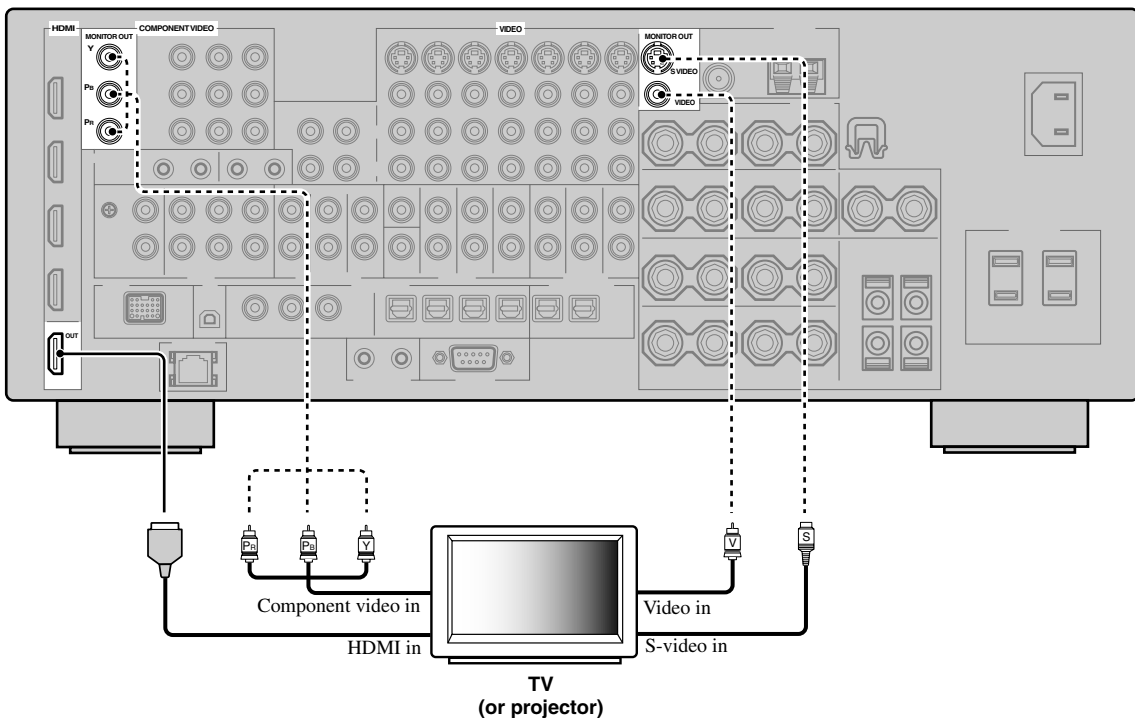

———— indicates recommended connections

- - - - - indicates alternative connections

Connecting other components



Make sure that this unit and other components are unplugged from the AC wall outlets.

Notes

- When “Conversion” is set to “Off” (see page 89), be sure to make the same type of video connections as those made for your TV (see page 23). For example, if you connected your TV to the VIDEO MONITOR OUT jack of this unit, connect your other components to the VIDEO jacks.
- When “Conversion” is set to “On” (see page 89), the converted video signals are output only at the MONITOR OUT jacks. When recording a source, you must make the same type of video connections between each component.
- To make a digital connection to a component other than the default component assigned to each DIGITAL INPUT or DIGITAL OUTPUT jack, select the corresponding setting for “Option”, “Optical Output”, or “Coaxial Input” in “I/O Assignment” (see page 82).
- If you connect your DVD player to both the DIGITAL INPUT (OPTICAL) and the DIGITAL INPUT (COAXIAL) jacks, priority is given to the signals input at the DIGITAL INPUT (COAXIAL) jack.

■ Connecting a Blu-ray Disc or HD DVD player

Connect your Blu-ray Disc or HD DVD player to the HDMI IN1 jack of this unit to perform the features of the Blu-ray Disc or HD DVD completely.

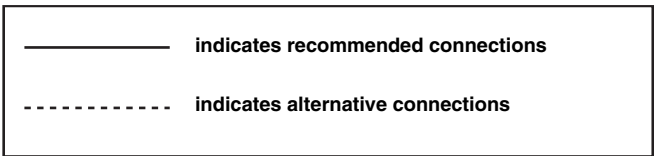
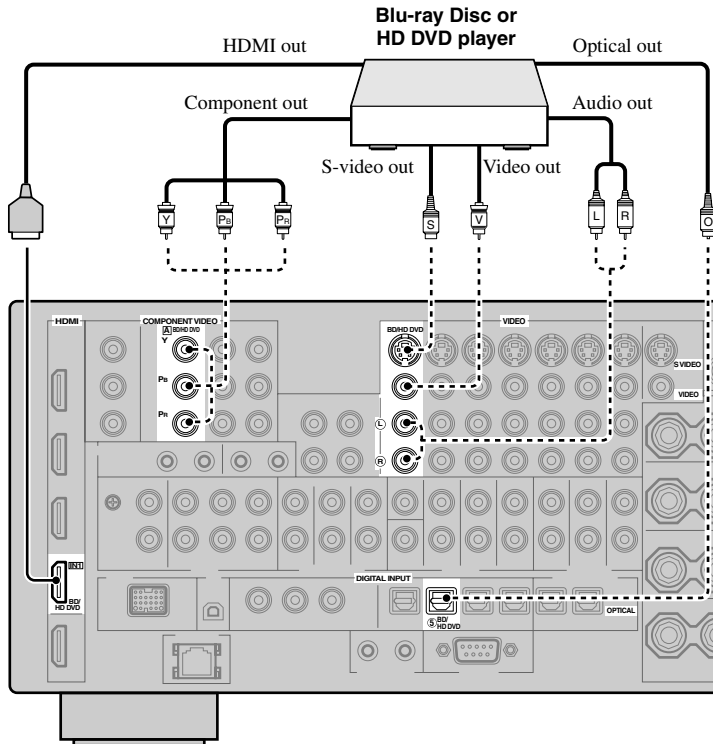

■ Connecting a DVD player

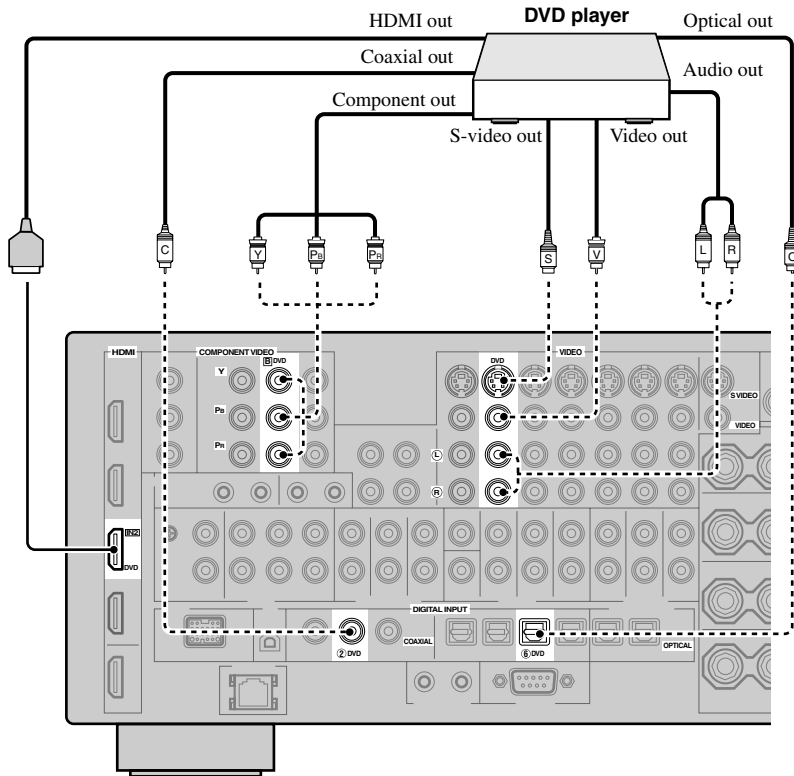

———— indicates recommended connections
 - - - - - indicates alternative connections

■ Connecting a set-top box

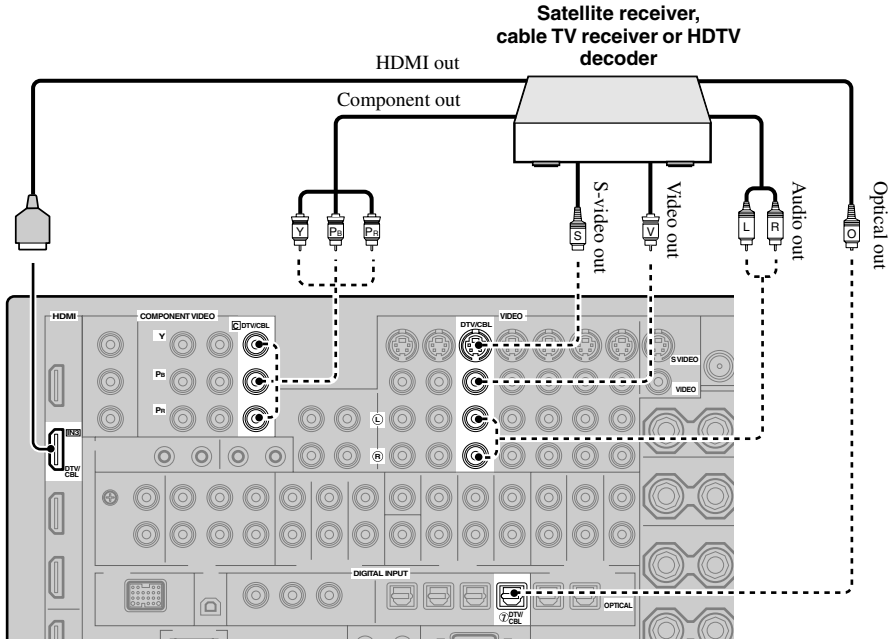

■ Connecting a DVD recorder, PVR or VCR

Note

* When you connect another VCR to this unit, connect it to the VCR terminals (S VIDEO IN, VIDEO IN, AUDIO IN, S VIDEO OUT, VIDEO OUT and AUDIO OUT jacks) same as DVR terminals except the DIGITAL INPUT (COAXIAL) jack.

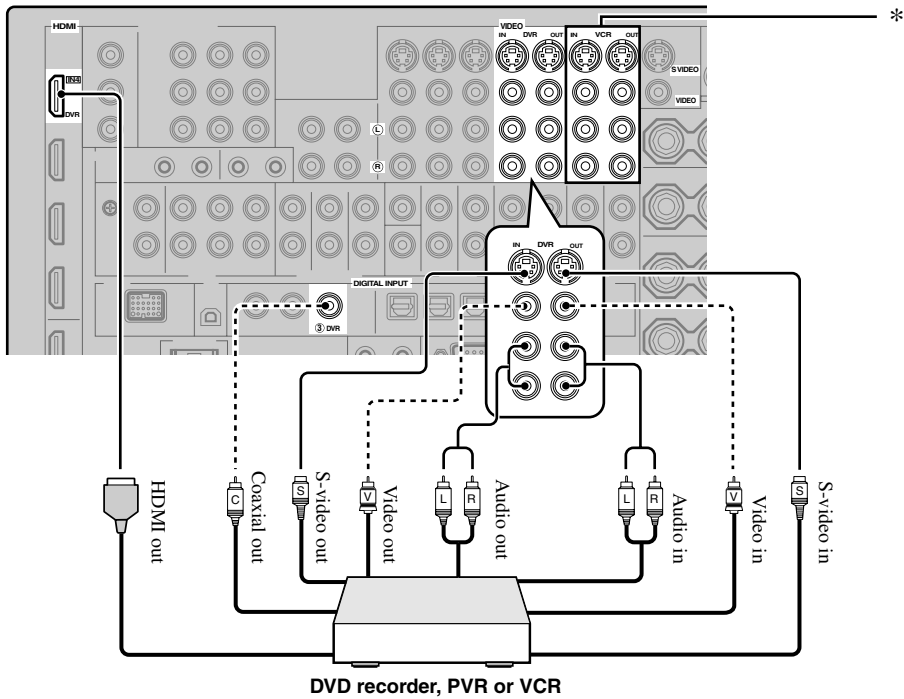

■ Connecting audio components

Notes

- Connect your turntable to the GND terminal of this unit to reduce noise in the signal. However, you may hear less noise without the connection to the GND terminal for some turntables.
- The PHONO jacks are only compatible with a turntable with an MM or a high-output MC cartridge. To connect a turntable with a low-output MC cartridge to the PHONO jacks, use an in-line boosting transformer or an MC-head amplifier.
- When you connect both the DIGITAL INPUT (OPTICAL) jack and the DIGITAL INPUT (COAXIAL) jack to an audio component, the priority is given to the DIGITAL INPUT (COAXIAL) jack.

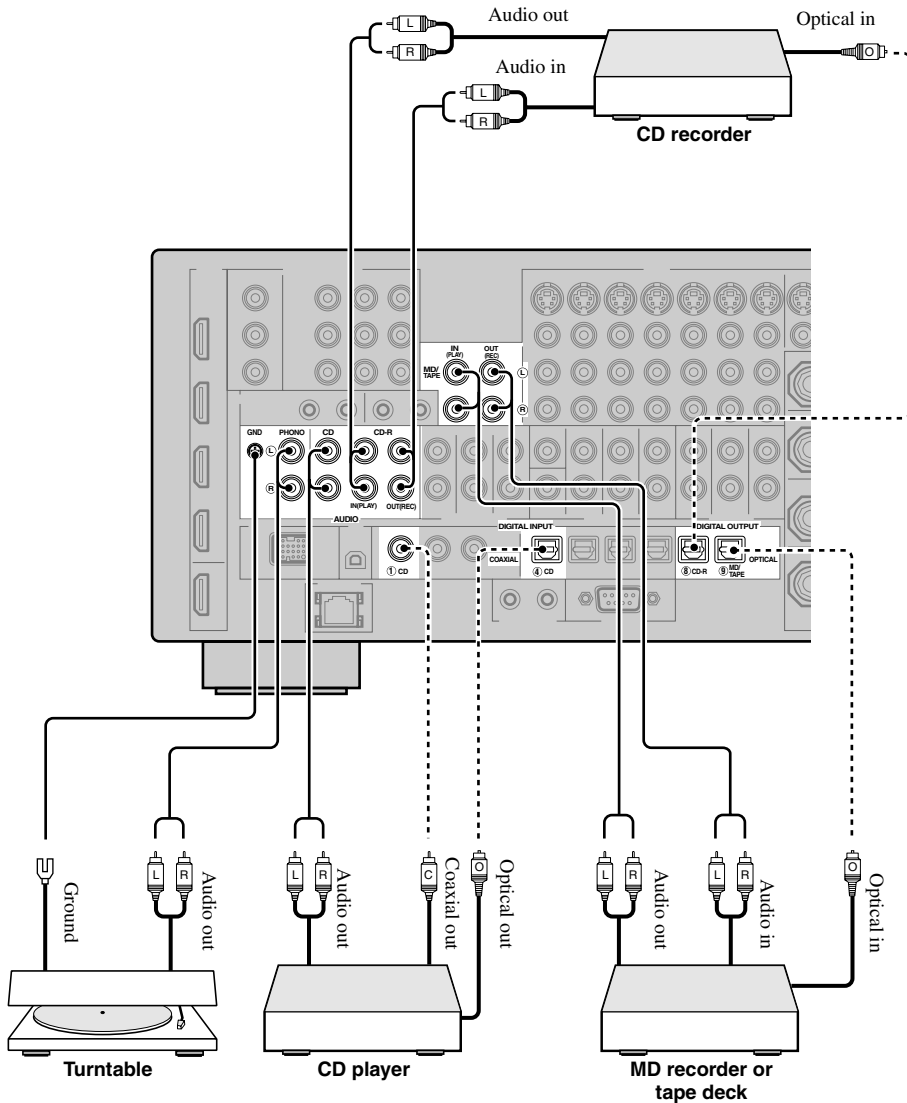

— indicates recommended connections
 - - - indicates alternative connections

■ Connecting an external amplifier

This unit has more than enough power for any home use. However, if you want to add more power to the speaker output or if you want to use another amplifier, connect an external amplifier to the PRE OUT jacks.

Notes

- When you make connections to the PRE OUT jacks, do not make connections to the SPEAKERS terminals.
- Each PRE OUT jack outputs the same channel signals as the corresponding SPEAKERS terminals.
- Adjust the volume level of the subwoofer with the control on the subwoofer (see page 52).
- Some signals may not be output at the SUBWOOFER PRE OUT jack depending on the settings for “Speaker Set” (see page 91) and “Bass Out” (see page 92).
- You can use the automatic setup feature even if you use an external amplifier (see page 37).

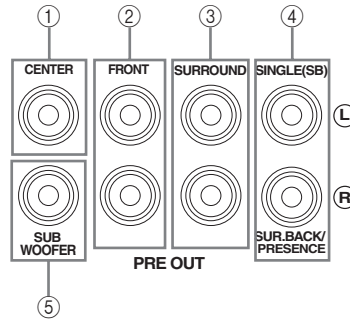

① CENTER PRE OUT jack

Center channel output jack.

② FRONT PRE OUT jacks

Front channel output jacks.

③ SURROUND PRE OUT jacks

Surround channel output jacks.

④ SURROUND BACK/PRESENCE PRE OUT jacks

Surround back or presence channel output jacks. When you only connect one external amplifier for the surround back channel, connect it to the SINGLE (SB) jack.



- Set the “Surround Back” to “Large x2”, “Large x1”, “Small x2” or “Small x1” and “Presence” to “None” (see page 92) to output the surround back channel signals at SURROUND BACK/PRESENCE PRE OUT jacks.
- Set the “Presence” to “Yes” and “Surround Back” to “None” (see page 92) to output the presence channel signals at SURROUND BACK/PRESENCE PRE OUT jacks.
- When “BI-AMP” is set to “ON” (see page 19), this unit output the front channel audio signals at the SUR.BACK/PRESENCE PRE OUT jacks.

⑤ SUBWOOFER PRE OUT jack

Connect a subwoofer with a built-in amplifier.

■ Connecting a multi-format player or an external decoder

This unit is equipped with 6 additional input jacks (left and right FRONT, CENTER, left and right SURROUND and SUBWOOFER) for discrete multi-channel input from a multi-format player, external decoder, sound processor or pre-amplifier.

If you set “Input Channels” to “8ch” in “MULTI CH” (see page 83), you can use the input jacks assigned as “Front Input” in “Multi CH Assign” (see page 83) together with the MULTI CH INPUT jacks to input 8-channel signals. Connect the output jacks on your multi-format player or external decoder to the MULTI CH INPUT jacks. Be sure to match the left and right outputs to the left and right input jacks for the front and surround channels.

Notes

- When you select the component connected to the MULTI CH INPUT jacks as the input source (see page 42), this unit automatically turns off the digital sound field processor, and you cannot select sound field programs.
- This unit does not redirect signals input at the MULTI CH INPUT jacks to accommodate for missing speakers. We recommend that you connect at least a 5.1-channel speaker system before using this feature.
- When the component connected to the MULTI CH INPUT jacks of this unit is selected as the input source, only the signals input at MULTI CH INPUT FRONT jacks are output from the connected headphones.

For 6-channel input

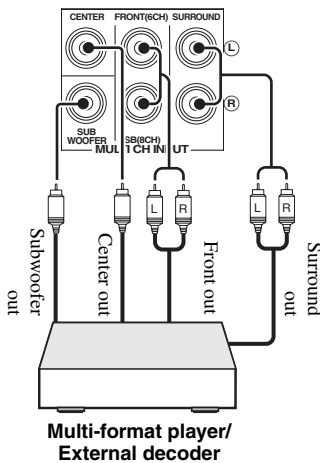

For 8-channel input

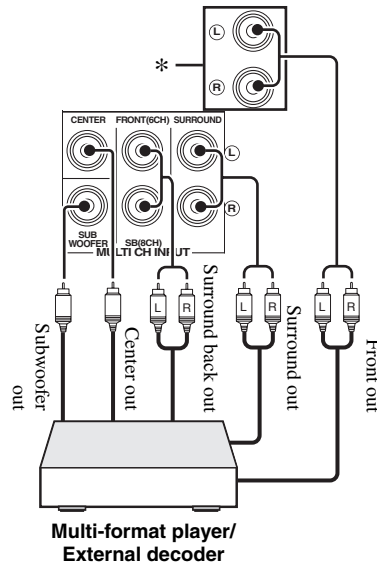

Note

- * The analog audio input jacks assigned as “Front Input” in “Multi CH Assign” (see page 83).

■ Connecting a Yamaha iPod universal dock

This unit is equipped with the DOCK terminal on the rear panel that allows you to connect a Yamaha iPod universal dock (such as the YDS-10, sold separately) where you can station your iPod and control playback of your iPod using the supplied remote control. Connect a Yamaha iPod universal dock (such as the YDS-10, sold separately) to the DOCK terminal on the rear panel of this unit using its dedicated cable.

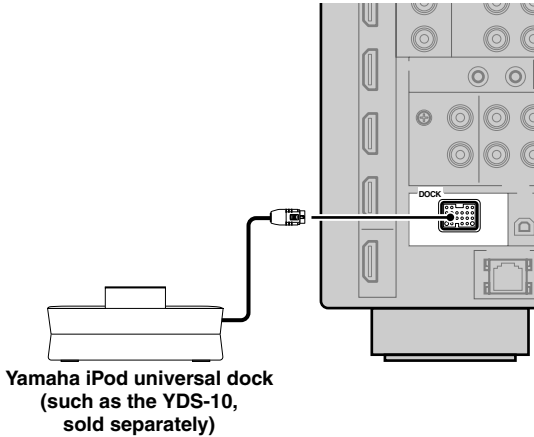

■ Using REMOTE IN/OUT jacks

When the components are the Yamaha products and have the capability of the transmission of the remote control signals, connect the REMOTE IN and REMOTE OUT jacks with the monaural analog mini cable as follows. See page 117 for more details of this feature.

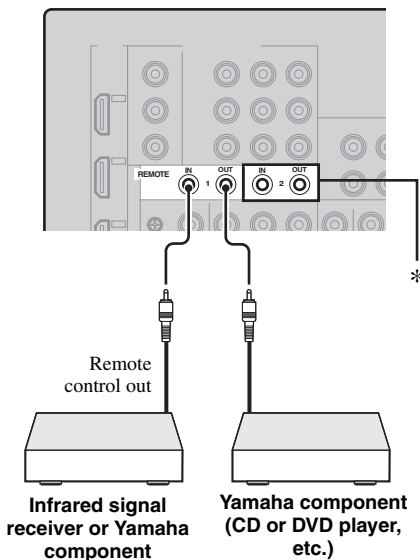

* You can connect another set of infrared signal receiver and Yamaha component to the REMOTE IN 2 and OUT 2 jacks same as the REMOTE IN 1 and OUT 1 jacks.

Using the VIDEO AUX jacks on the front panel

Use the VIDEO AUX jacks on the front panel to connect a game console or a video camera to this unit.

Caution

Be sure to turn down the volume of this unit and other components before making connections.

Note

The audio signals input at the DOCK terminal on the rear panel take priority over the ones input at the VIDEO AUX jacks.

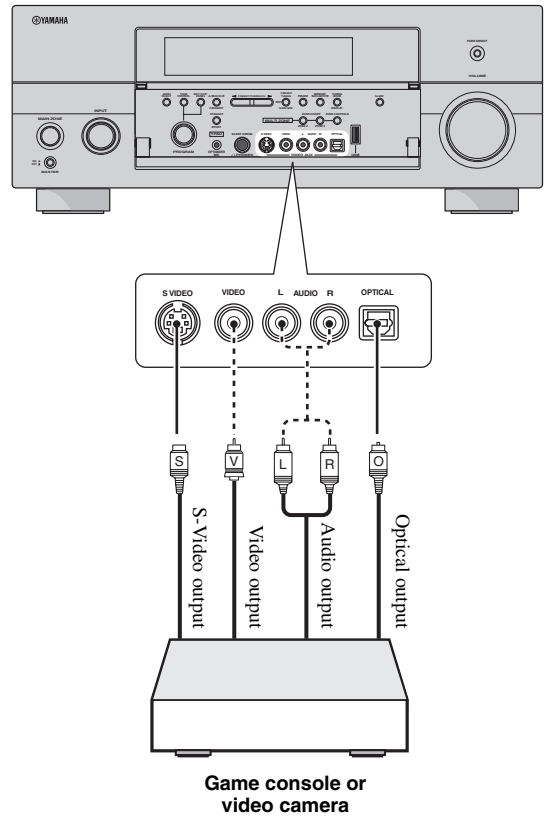

Connecting the network

To connect this unit to your network, plug one end of a network cable (CAT-5 or higher straight cable) into the NETWORK port of this unit, and plug the other end into one of the LAN ports on your router that supports the DHCP (Dynamic Host Configuration Protocol) server function. The following diagram shows a connection example where this unit is connected to one of the LAN ports on a 4-port router. To enjoy music files saved on your PC and Yamaha MCX-2000 or access the Internet Radio, each device must be connected properly in the network.

Notes

- You must use an STP cable (commercially available) to connect a network hub or router and this unit.
- If the DHCP server function on your router is disabled, you need to configure the network settings manually (see page 94).
- Yamaha MCX-2000, MCX-A10 and MCX-C15 may not be for sale in same locations.

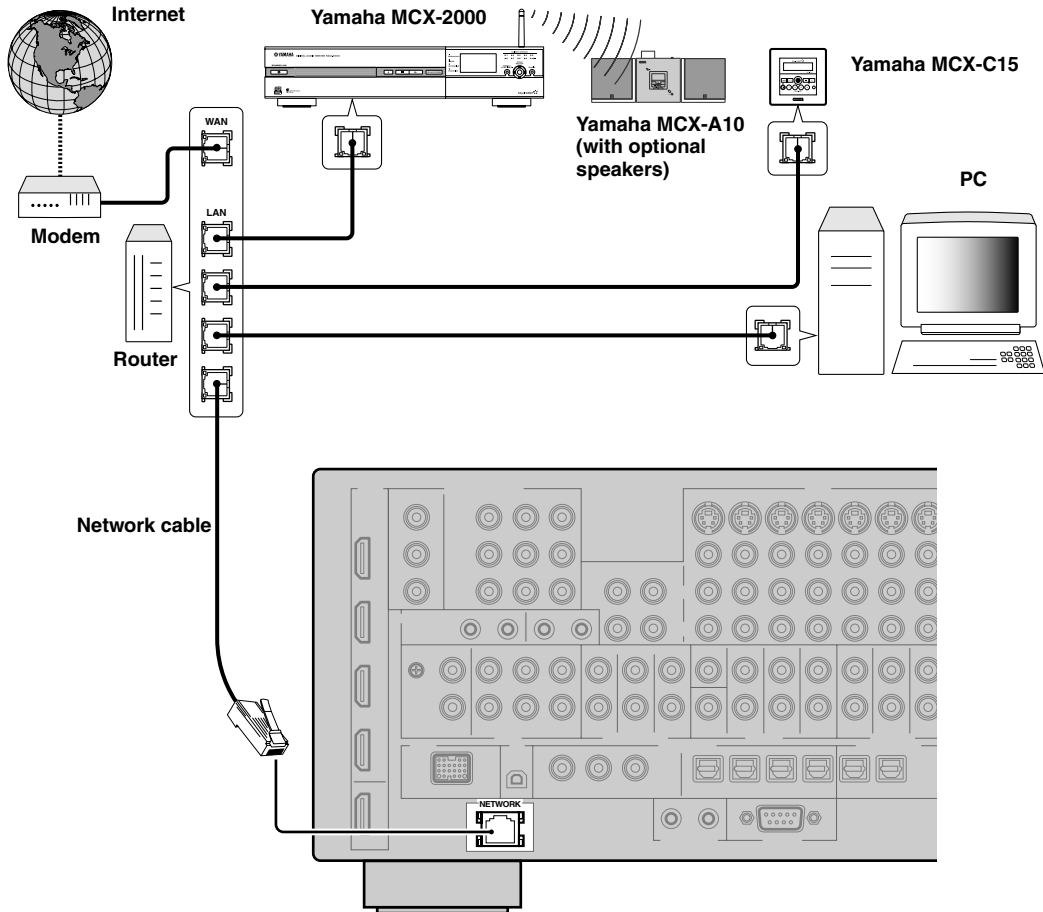

Connecting the FM and AM antennas

Both FM and AM indoor antennas are supplied with this unit. Connect each antenna correctly to the designated terminals. In general, these antennas should provide sufficient signal strength.

Notes

- (Asia and General models only) Be sure to set the tuner frequency step according to the frequency spacing in your area (see page 126).
- The AM loop antenna should be placed away from this unit.
- The AM loop antenna should always be connected, even if an outdoor AM antenna is connected to this unit.
- A properly installed outdoor antenna provides clearer reception than an indoor one. If you experience poor reception quality, install an outdoor antenna. Consult the nearest authorized Yamaha dealer or service center about outdoor antennas.

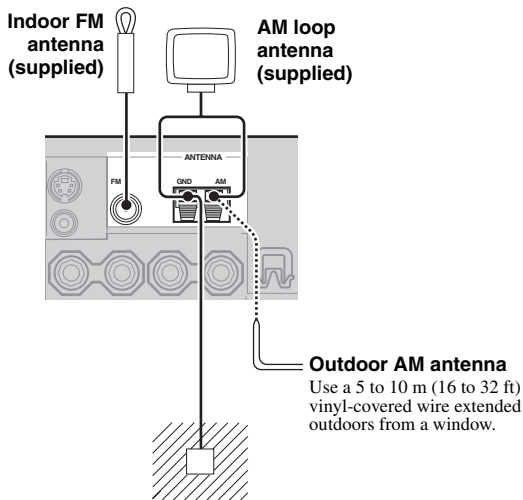

For maximum safety and minimum interference, connect the antenna GND terminal to a good earth ground. A good earth ground is a metal stake driven into moist earth.

Connecting the power cable

■ Connecting the AC power cable

Plug the supplied AC power cable into the AC inlet after all other connections are complete, then plug the AC power cable into an AC wall outlet.

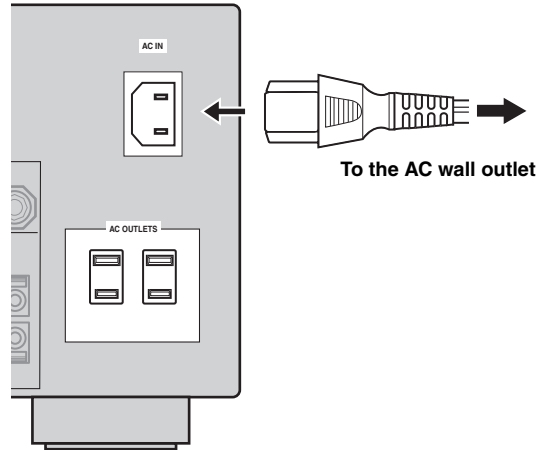

Note

(Asia model only) Select one of the supplied power cables suitable for the type of AC wall outlet in your location before plugging this unit into the AC wall outlet.

■ AC OUTLET(S) (SWITCHED)

U.K. and Australia models..... 1 outlet
Korea model..... None
Other models..... 2 outlets

Use these outlet(s) to supply power to any connected components. Connect the power cable of your other components to these outlet(s). Power to these outlet(s) is supplied when this unit is turned on. However, power to these outlet(s) is cut off when this unit is turned off. For information on the maximum power or the total power consumption of the components that can be connected to these outlet(s), see "Specifications" on page 144.

Memory back-up

The memory back-up circuit prevents the stored data from being lost even if this unit is in the standby mode. However, the stored data will be lost in case the power cable is disconnected from the AC wall outlet or if the power supply is cut off for more than one week.

Setting the speaker impedance and GUI language

Caution

If you are to use 6-ohm speakers, set “SPEAKER IMP.” to “6ΩMIN” as follows BEFORE using this unit. You can also use 4-ohm speakers as the front speakers.

Before using this unit, set the speaker impedance of the connected speakers and the language of the menu items and messages, that appears in the GUI (graphical user interface) screen of this unit.

- 1 Make sure this unit is turned off.
- 2 Press and hold **ⓅSTRAIGHT** on the front panel and then press **ⓂMASTER ON/OFF** inward to the ON position to turn on this unit. This unit turns on, and the advanced setup menu (see page 122) appears in the front panel display.



- 3 Rotate the **ⓄPROGRAM** selector to select “SPEAKER IMP.”.
- 4 Press **ⓅSTRAIGHT** repeatedly to select “6ΩMIN”.
- 5 Rotate the **ⓄPROGRAM** selector to select “GUI LANGUAGE”.
- 6 Press **ⓅSTRAIGHT** repeatedly to select the desired language setting for the GUI screen in the video monitor.

Choices: **ENGLISH** (English), **JAPANESE** (Japanese), **FRENCH** (French), **GERMAN** (German), **SPANISH** (Spanish), **RUSSIAN** (Russian)

Notes

- This setting does not affect to the messages that appear in the front panel display.
- You can also select the GUI language by using GUI screen. See page 99 for details.

- 7 Press **ⓂMASTER ON/OFF** to release it outward to the OFF position to save the new setting and turn off this unit.

The setting you made is reflected next time you turn on this unit.

Turning this unit on and off

Turning on this unit

Press **ⓂMASTER ON/OFF** on the front panel inward to the ON position to turn on this unit. When you turn on this unit by pressing **ⓂMASTER ON/OFF**, the main zone is turned on.



When you turn on this unit, there will be a delay for a few seconds before this unit can reproduce sound.

Turning off this unit

Press **ⓂMASTER ON/OFF** on the front panel again to release it outward to the OFF position to turn off this unit.

Notes

- **ⓂMAIN ZONE ON/OFF** on the front panel as well as **ⓅPOWER** and **ⓂSTANDBY** on the remote control are operational only when **ⓂMASTER ON/OFF** is pressed inward to the ON position.
- Basically, we recommend that you use the standby mode to turn off this unit.

Turning on the main zone from the standby mode

Press **ⓂMAIN ZONE ON/OFF** (or **ⓂSTANDBY**) to set the main zone to the standby mode.

In the standby mode, this unit consumes a small amount of power in order to receive infrared signals from the remote control.

Set the main zone to the standby mode

Press **ⓂMAIN ZONE ON/OFF** (or **ⓅPOWER**) to turn on the main zone.



- When you turn on this unit, there will be a delay for a few seconds before this unit can reproduce sound.
- These buttons are operational only when **ⓂMASTER ON/OFF** is pressed inward to the ON position.

If there are some problems...

- First, turn off and then turn on this unit again.
- If problems persist, initialize the parameters of this unit. See page 137 for details.

Using the remote control

The remote control transmits a directional infrared ray. Be sure to aim the remote control directly at the remote control sensor on this unit during operation.

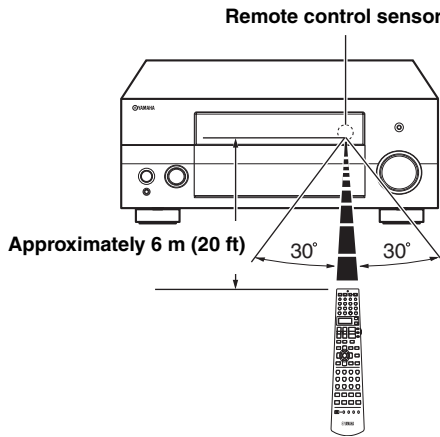

② LIGHT

Lights up the remote control buttons and the display window (⑫).

Display window (⑫)

Shows the name of the selected input source that you can control.

Infrared window (⑳)

Outputs infrared control signals. Aim this window at the component you want to operate.

Transmit indicator (㉑)

Flashes while the remote control is sending infrared signals.

Operation mode selector (⑭)

The function of some buttons depends on the operation mode selector position.

AMP

Operates the amplifier function of this unit.

SOURCE

Operates the component selected with an input selector button (see page 106).

TV

Operates the TV assigned to either DTV/CBL or PHONO (see page 105).

Notes

- Do not spill water or other liquids on the remote control.
- Do not drop the remote control.
- Do not leave or store the remote control in the following types of conditions:
 - places of high humidity, such as near a bath
 - places of high temperatures, such as near a heater or stove
 - places of extremely low temperatures
 - dusty places

Opening and closing the front panel door

When you want to use the controls behind the front panel door, open the door by gently pressing on the lower part of the panel. Keep the door closed when not using these controls.

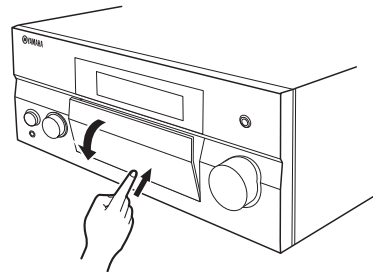

To open, press gently on the lower part of the panel.

Front panel display

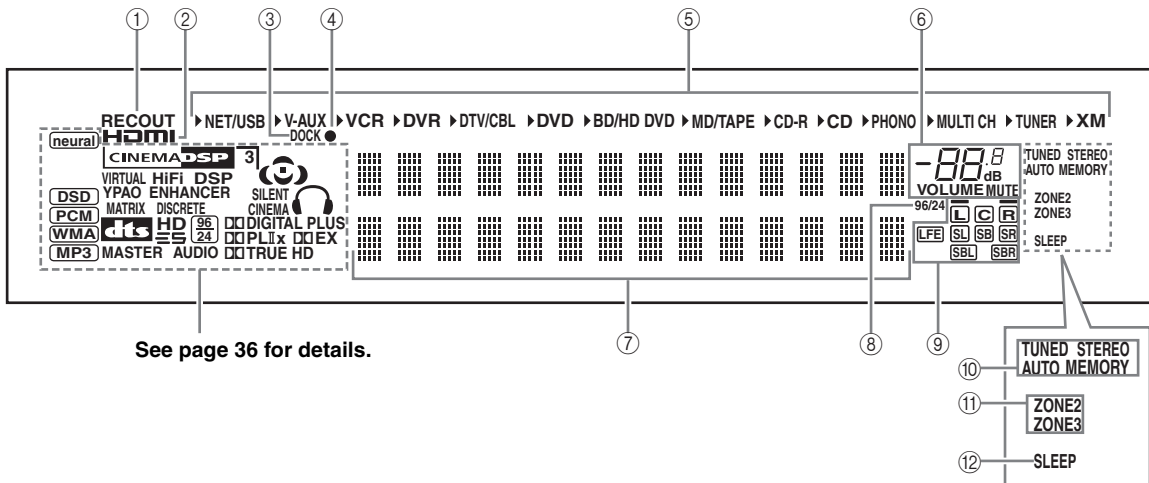

① RECOUT indicator

Lights up when this unit is in the recording input source selecting mode (see page 70).

② HDMI indicator

Lights up when the signal of the selected input source is input at one of the HDMI input jacks (see page 21).

③ DOCK indicator

Lights up when you station your iPod in a Yamaha iPod universal dock (such as the YDS-10, sold separately) connected to the DOCK terminal of this unit (see page 30).

④ Battery charge indicator

Lights up when this unit charges the battery of the stationed iPod in the standby mode of this unit (see page 62).

⑤ Input source indicators

The corresponding cursor lights up to show the currently selected input source.

Note

The XM indicator is only applicable to the U.S.A. and Canada models.

⑥ MUTE indicator and VOLUME level indicator

- Indicates the current volume level.
- The MUTE indicator flashes while the MUTE function is on (see page 43).

⑦ Multi-information display

Shows the name of the current sound field program and other information when adjusting or changing settings.

⑧ 96/24 indicator

Lights up when a DTS 96/24 signal is input to this unit.

⑨ Input channel and speaker indicators

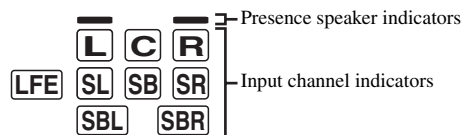

Input channel indicators

- Indicate the channel components of the current digital input signal.
- Light up or flash according to the settings of the speakers when this unit is in the auto setup procedure (see page 37) or the speaker level setting procedure in the “Speaker Level” (see page 94).

Presence speaker indicators

Light up according to setting for “Presence” (see page 92) in “Speaker Set” when this unit is in the auto setup procedure (see page 37) or the speaker level setting procedure in the “Speaker Level” (see page 94).



You can make settings for the presence and surround back speakers automatically by running “Auto Setup” (see page 37) or manually by adjusting settings for “Presence” (see page 92) and “Surround Back” (see page 92) in “Speaker Set”.

10 Tuner indicators

Lights up when this unit is in the FM, AM or XM Satellite Radio tuning mode.

TUNED indicator

Lights up when this unit is tuned into a station (see page 53).

STEREO indicator

Lights up when this unit is receiving a strong signal for an FM stereo broadcast while the AUTO indicator is lit (see page 53).

AUTO indicator

Lights up when this unit is in the automatic tuning mode (see page 53).

MEMORY indicator

Flashes to show that a station can be stored (see page 55).



MEMORY indicator also flashes while this unit is in the shortcut memory preset mode of NET/USB (see page 68).

11 ZONE2/ZONE3 indicators

Lights up when Zone 2 or Zone 3 is turned on (see page 117).

12 SLEEP indicator

Lights up while the sleep timer is on (see page 43).



13 neural indicator (U.S.A. and Canada models only)

Lights up when the Neural-THX Surround decoder is activated (see page 71).

14 YPAO indicator

Lights up when you run “Auto Setup” and when the speaker settings set in “Auto Setup” are used without any modifications (see page 37).

15 Input signal indicators

The respective indicator lights up when this unit is reproducing DSD (Direct Stream Digital), PCM (Pulse Code Modulation), WMA (Windows Media Audio), or MP3 (MPEG-1 Audio Layer-3) audio signals.

16 DSP indicators

The respective indicator lights up when any of the sound field programs are selected.

CINEMA DSP indicator

Lights up when you select a CINEMA DSP sound field program (see page 45).

HiFi DSP indicator

Lights up when you select a HiFi DSP sound field program (see page 51).

VIRTUAL indicator

Lights up when Virtual CINEMA DSP is active (see page 50).

3D indicator

Lights up when the CINEMA DSP 3D mode is active (see page 50).

17 Sound field indicators

Light up to indicate the active sound fields (see page 45).

18 ENHANCER indicator

Lights up when the Compressed Music Enhancer mode is turned on (see page 49).

19 Headphones indicator

Lights up when headphones are connected (see page 42).

20 SILENT CINEMA indicator

Lights up when headphones are connected and a sound field program is selected (see page 50).

21 Decoder indicators

The respective indicator lights up when any of the decoders of this unit function.

Optimizing the speaker setting for your listening room (YPAO)

This unit employs the YPAO (Yamaha Parametric Room Acoustic Optimizer) technology which lets you avoid troublesome listening-based speaker setup and achieves highly accurate sound adjustments automatically. The supplied optimizer microphone collects and this unit analyzes the sound your speakers produce in your actual listening environment.

Using the automatic setup (Auto Setup)

Notes

- Be advised that it is normal for loud test tones to be output during the automatic setup procedure.
 - To achieve the best results, make sure the room is as quiet as possible while the automatic setup procedure is in progress. If there is too much ambient noise, the results may not be satisfactory.
- 
- If an error occurs during the automatic setup procedure and an error or warning message appears in the GUI screen or in the front panel display, see the “Auto Setup” section in “Troubleshooting” on pages 135 and 136 for a complete list of error and warning messages and proper remedies.
 - The initial setting for each parameter is indicated in bold.
 - Before performing operations, set the operation mode selector on the remote control to **AMP**.

Basic procedure of the automatic setup

1 Make sure of the following check points before starting the automatic setup operations.

- Speakers are connected appropriately.
- Headphones are disconnected from this unit.
- This unit and the video monitor are turned on.
- The connected subwoofer is turned on and the volume level is set to about half way (or slightly less).

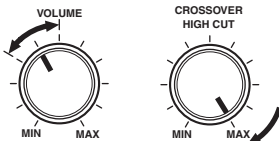

Controls of a subwoofer (example)

- The crossover frequency controls of the connected subwoofer is set to the maximum.
- If you use the external amplifiers (see page 28), the amplifiers are turned on and the settings are appropriate.
- The room is sufficiently quiet.

2 Connect the supplied optimizer microphone to the OPTIMIZER MIC jack on the front panel.

“MIC ON” and “View OSD MENU” appears in the front panel display.

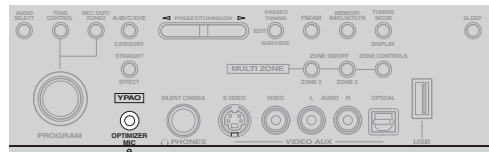

Omni-directional microphone

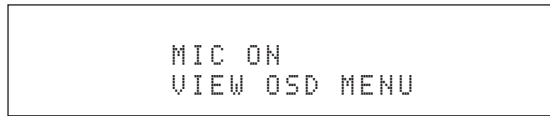

The following menu screen appears on the video monitor.

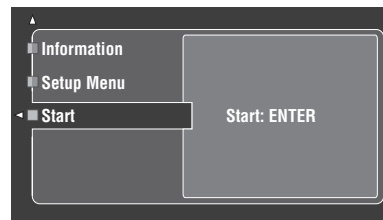

Following message appears in the front panel display after a while. You can only perform the automatic setup with the GUI menu.

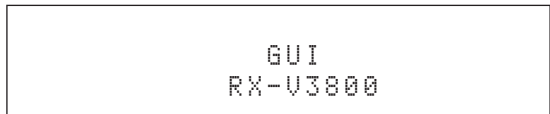

3 Place the optimizer microphone at your normal listening position on a flat level surface with the omni-directional microphone heading upward.

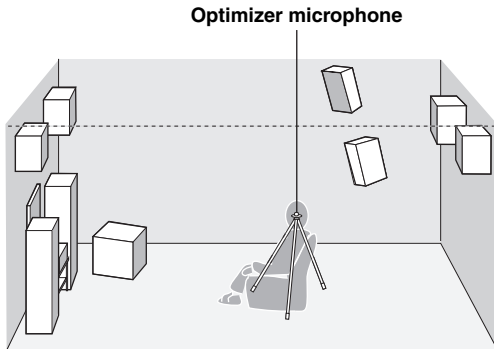

It is recommended that you use a tripod (etc.) to affix the optimizer microphone at the same height as your ears would be when you are seated in your listening position. You can use the attached screw of a tripod (etc.) to fix the optimizer microphone to the tripod (etc.).

Before proceeding next operation

Once you perform the next operation, this unit starts the automatic setup procedure immediately. For the accurate measurements, once you perform the next operation, we recommend that you get out of the room or move to the position where you do not interrupt the accurate measurements (for example, along the wall with no speakers installed nearby).

4 Press $\text{4} \blacktriangleright$ ENTER to start the setup procedure.

This unit starts the automatic setup procedure immediately. Loud test tones are output from each speaker during the automatic setup procedure. During the setup procedure, “Measuring...” appears in the GUI screen.

Notes

- During the automatic setup procedure, do not perform any operation on this unit.
- We recommend that you get out of the room while this unit is in the automatic setup procedure. Keep quiet when you leave the room. The necessary time for the automatic setup procedure may differ depending on the environment of the listening room and connected speakers (from 30 seconds to 3 minutes).



To stop the automatic setup procedure and set this unit to the pause mode, press one of the cursor buttons ($\text{4} \blacktriangle / \blacktriangledown / \blacktriangleleft / \blacktriangleright$) or $\text{4} \blacktriangleright$ ENTER. In the pause mode, press $\text{4} \blacktriangle$ to retry the procedure, and $\text{4} \blacktriangleleft$ to cancel the Auto Setup procedure.

5 Once all items are set successfully, following display appears in the GUI screen.

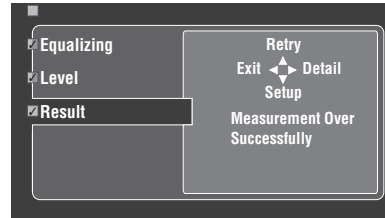

- Press $\text{4} \blacktriangledown$ and select “Setup” to set the measured values.
- Press $\text{4} \blacktriangle$ and select “Retry” to retry the automatic setup procedure. This unit starts the automatic setup procedure immediately again.
- Press $\text{4} \blacktriangleright$ and select “Detail” to view information about measurement results and warning messages. In the information display, press $\text{4} \blacktriangle / \blacktriangledown$ repeatedly to toggle between the parameters. For more details about warning messages, see the “Auto Setup” section in “Troubleshooting” on page 135.
- Press $\text{4} \blacktriangleleft$ and select “Exit” to exit from the Auto Setup procedure. If you select “Exit”, “Don’t Setup?” appears on the screen. To set the measured values and exit, select “Setup”. To cancel the settings and exit, select “Cancel”.



If you are not satisfied with the results or want to manually adjust each parameter, set the parameters in “Basic” (see page 91).

Notes

- If you change speakers, speaker positions, or the layout of your listening environment, run “Auto Setup” again to recalibrate your system.
- The distances displayed in the “Distance” results may be longer than the actual distance depending on the characteristics of your subwoofer or external amplifiers if you connect them.
- In the “Equalizing” results, different values may be set for the same band to provide finer adjustments.

If warning message appears...

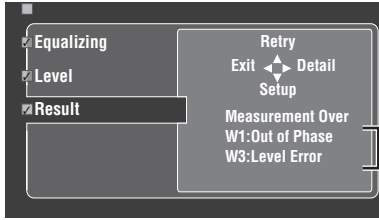

Warning messages

When this unit detects potential problems during the automatic setup procedure, warning messages appears in the result display. See the “Auto Setup” section in “Troubleshooting” on page 135 for a complete list of warning messages and proper remedies.

6 Press ⑰ SET MENU to exit from the GUI screen.

Notes

- After you have completed the automatic setup procedure, be sure to disconnect the optimizer microphone.
- The optimizer microphone is sensitive to heat. Keep it away from direct sunlight and do not place it on top of this unit.

Customizing the measurements

You can select the parametric equalizer type, and activate or deactivate each check items.

1 Connect the supplied optimizer microphone to this unit and place the microphone appropriately.

Refer to the steps 1 to 3 of “Basic procedure” on page 41.

2 Press ④△ to select “Setup Menu” and then ④▷.

“Setup Menu” is selected as the currently selected menu item.

3 Press ④△ / ▽ repeatedly to select “Wiring”, “Distance”, “Size”, “Equalizing”, or “Level”, and then press ④▷ to set the selected parameter.

4 Press ④△ / ▽ repeatedly to select the desired parameter and then ④ENTER to confirm the selection.

5 Repeat steps 3 and 4 until you set all the desired parameters.

This unit performs the following checks:

Wiring (Speaker wiring)

Checks which speakers are connected and the polarity of each speaker.

Distance (Speaker distance)

Checks the distance of each speaker from the listening position and adjusts the timing of each channel.

Size (Speaker size)

Checks the frequency response of each speaker and sets the appropriate low-frequency crossover for each channel.

Choices: **Check**, Skip

- Select “Check” to automatically check and adjust the item.
- Select “Skip” to skip the item and perform no adjustments.

Equalizing (Parametric equalizer level)

Parametric equalizer adjusts the level of the specified frequency bands. This unit automatically selects the crucial frequency bands for the listening room and adjusts the level of the selected frequency bands to create a cohesive sound field in the room. You can select the type of the parametric equalizer adjustment from the following choices.

Choices: **Check:Natural**, Check:Flat, Check:Front, Skip

- Select “Check:Natural” to average out the frequency response of all speakers with higher frequencies being less emphasized. Recommended if the “Check:Flat” setting sounds a little harsh.
- Select “Check:Flat” to average the frequency response of all speakers. Recommended if all of your speakers are of similar quality.
- Select “Check:Front” to adjust the frequency response of each speaker in accordance with the sound of your front speakers. Recommended if your front speakers are of much higher quality than your other speakers.
- Select “Skip” to skip the selected item and perform no adjustments.

Level (Volume level)

Checks and adjusts the volume level of each speaker.

Choices: **Check**, Skip

- Select “Check” to automatically check and adjust this item.
- Select “Skip” to skip this item and perform no adjustments.



A check mark appears at the left of the parameter you set other than “Skip”.

6 Once you have selected the desired settings of each parameter, press **⏪** to return to the previous menu level and then press **⏩** to select “Start”.

7 After the setting of the measurement, start the automatic setup procedure.

Refer to steps 4 to 6 of “Basic procedure of the automatic setup” on page 37 for details.

System Memory feature

You can save multiple result of the automatic setup by using the System Memory feature. See page 100 for details.

■ Reviewing the result of the automatic setup

Use this feature to review the result of the automatic setup.

1 Set the operation mode selector to **AMP** and then press **SET MENU** to turn on the GUI screen.

2 Press **⏶** / **⏷** repeatedly and then **⏵** to select “Auto Setup”.

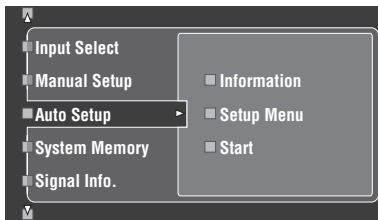

3 Press **⏶** to select “Information”.

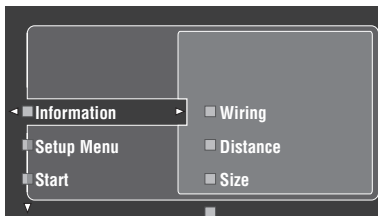

4 Press **⏵** and then **⏷** repeatedly to select the desired check items.

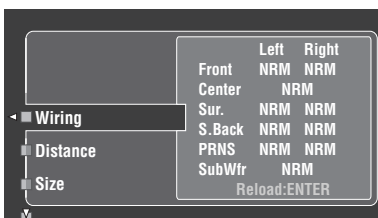

Wiring (Speaker wiring)

Displays the polarity of each connected speaker.

- “NRM” appears when the polarity of the connected speaker is normal.
- “REV” appears when the polarity of the connected speaker is reversed.

Note

“—” appears when no speaker is connected to the corresponding speaker channel.

Distance (Speaker distance)

Displays the speaker distance from the listening position. Press **⏶** / **⏷** to switch the unit to display the value of the each speaker distance.

Note

“—” appears when no speaker is connected to the corresponding speaker channel.

Size (Speaker size)

Displays the size of the connected speakers. The bass cross over frequency (“Cross”) appears at the bottom of the menu area.

- “LRG” appears when the connected speaker has the ability to reproduce the low-frequency signals effectively.
- “SML” appears when the connected speaker does not have the ability to reproduce the low-frequency signals effectively.

Note

“—” appears when no speaker is connected to the corresponding speaker channel.

Equalizing (Speaker equalizing)

Displays the result of the adjustment of the frequency responses of each connected speaker.

Note

“—” appears when no speaker is connected to the corresponding speaker channel.

Level (speaker level)

Displays the speaker output level of the connected speakers.

Note

“—” appears when no speaker is connected to the corresponding speaker channel.

Playback

Caution

Extreme caution should be exercised when you play back CDs encoded in DTS. If you play back a CD encoded in DTS on a DTS-incompatible CD player, you will only hear some unwanted noise that may damage your speakers. Check whether your CD player supports CDs encoded in DTS. Also, check the sound output level of your CD player before you play back a CD encoded in DTS.



To play DTS-encoded CDs when using a digital audio connection, set "Decoder Mode" in "Input Select" to "DTS" before playback (see page 82).

Before performing the following operations, set the operation mode selector on the remote control to **AMP**.

Basic procedure

1 Turn on the video monitor connected to this unit.



- You can control this unit by using the graphical user interface (GUI) screen. See page 44 for details.
- You can turn on or off the short message displays on the video monitor. See page 90 for details.

2 Rotate the **INPUT** selector (or set the operation mode selector to **AMP** and then press one of the input selector buttons (1)) to select the desired input source.

The name of the currently selected input source appears in the front panel display and in the short message display for a few seconds.

Available input sources

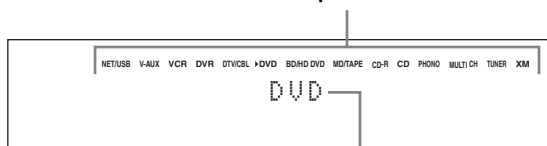

Currently selected input source

3 Start playback on the selected source component or select a broadcast station.

- Refer to the instruction manuals for the source component.
- See page 53 for details about FM/AM tuning instructions.
- See page 56 for details about XM Satellite Radio tuning instruction.
- See page 62 for details about the iPod operation with this unit.
- See page 64 for details about playback of Internet Radio programs and the music contents in the PC or USB memory devices.

4 Rotate **VOLUME** (or press **VOLUME +/-**) to adjust the volume to the desired output level.

Control range: Mute, -80.0 dB (minimum) to +16.5 dB (maximum)



See page 52 to adjust the level of each speaker.

5 Rotate the **PROGRAM** selector on the front panel (or press one of the sound field program selector buttons (25)) repeatedly to select the desired sound field program.

The name of the selected sound field program appears in the front panel display and in the short message display. See page 45 for details about sound field programs.

Currently selected sound field program category

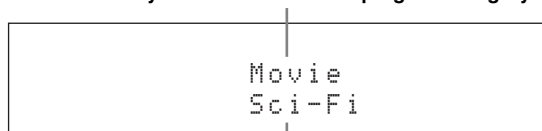

Currently selected sound field program

Note

Sound field programs cannot be selected when the component connected to the MULTI CH INPUT jacks is selected as the input source (see page 42).



- Choose a sound field program based on your listening preference, not merely on the name of the program.
- When you select an input source, this unit automatically selects the last sound field program used with the corresponding input source.

Selecting audio input jacks (AUDIO SELECT)

This unit comes with a variety of input jacks. Use this feature (audio input jack select) to switch the input jack assigned to an input source when more than one jacks are assigned to an input source.



- We recommend setting the audio input jack select to “AUTO” in most cases.
- You can adjust the default the audio input jack select of this unit by using “Audio Select” in “Option” (see page 98).
- You can also set the audio input jack select setting in “Audio Select” in “Input Select” (see page 82).

1 Rotate the **ⓈINPUT selector (or press one of the input selector buttons (①)) to select the desired input source.**

2 Press **ⓈAUDIO SELECT (or **Ⓢ**AUDIO SEL) repeatedly to select the desired Audio input jack select setting.**

Available input sources

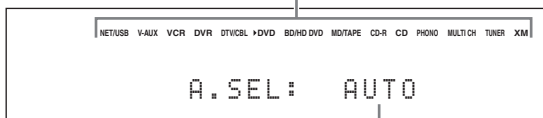

Currently selected Audio input jack select setting

AUTO	Automatically selects input signals in the following order: (1) HDMI (2) Digital signals (3) Analog signals
HDMI	Selects only HDMI signals. When HDMI signals are not input, no sound is output.
COAX/OPT	Automatically selects input signals in the following order: (1) Digital signals input at the COAXIAL jack. (2) Digital signals input at the OPTICAL jack. When no signals are input, no sound is output.
ANALOG	Selects only analog signals. If no analog signals are input, no sound is output.

Note

This feature is not available when no digital input jack (OPTICAL, COAXIAL and HDMI) are assigned. Use “I/O Assignment” in “Input Select” to reassign the respective input jack (see page 82).

Selecting the MULTI CH INPUT component

Use this feature to select the component connected to the MULTI CH INPUT jacks (see page 29) as the input source.

Rotate the **ⓈINPUT selector on the front panel to select MULTI CH (or press **①**MULTI CH IN).**



Use “MULTI CH” menu in “Input Select” to set the parameters for MULTI CH (see page 83).

Note

Sound field programs and the Compressed Music Enhancer mode cannot be selected when the component connected to the MULTI CH INPUT jacks is selected as the input source (see page 45).

Using your headphones

Connect a pair of headphones with a stereo analog audio cable plug to the PHONES jack on the front panel.

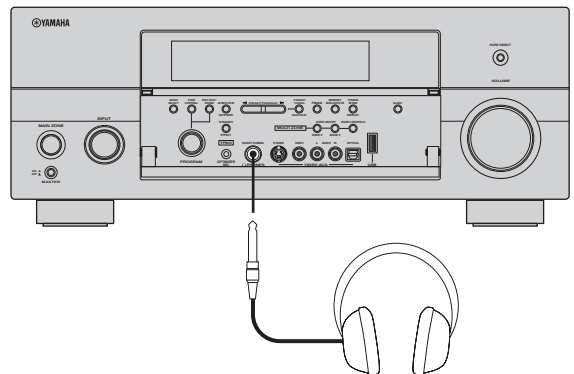

When you select a sound field program, SILENT CINEMA mode activates automatically (see page 50).

Notes

- When you connect headphones, no signals are output at the speaker terminals.
- When the component connected to the MULTI CH INPUT jacks of this unit is selected as the input source, only the signals input at the MULTI CH INPUT FRONT jacks are output from the connected headphones.
- All digital multi-channel audio signals (except DSD signals) are mixed down to the left and right headphone channels.

Muting the audio output

Press **MUTE** on the remote control to mute the audio output. Press **MUTE** again to resume the audio output.



- You can also rotate **VOLUME** on the front panel or press **VOLUME +/-** on the remote control to resume the audio output.
- You can adjust the muting level by using the “Muting Type” parameter in “Volume” (see page 84).
- The MUTE indicator flashes in the front panel display when the audio output is muted and disappears from the front panel display when the audio output is resumed.

Playing video sources in the background of an audio source

You can combine a video image from a video source with sound from an audio source. For example, you can enjoy listening to classical music while viewing beautiful scenery from the video source on the video monitor.

Press the input selector buttons (1) to select a video source and then an audio source.



Set the “BGV” parameter in the “MULTI CH” menu to the desired setting to select the default background video input source of the MULTI CH INPUT sources (see page 83).

Using the sleep timer

Use this feature to automatically set the main zone to the standby mode after a certain amount of time. The sleep timer is useful when you are going to sleep while this unit is playing or recording a source. The sleep timer also automatically turns off any external components connected to the AC OUTLET(S) (see page 32).

1 Rotate the **INPUT** selector (or press one of the input selector buttons (1)) to select the desired input source.

2 Start playback on the selected source component or select a broadcast station.

Refer to the operating instructions for the source component.

See page 53 for details about tuning instructions.

3 Press **SLEEP** (or **SLEEP**) repeatedly to set the amount of time.

Each time you press **SLEEP** (or **SLEEP**), the front panel display changes as shown below.

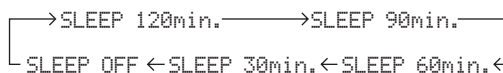

The SLEEP indicator flashes while you are switching the amount of time for the sleep timer. Once the sleep timer is set, the SLEEP indicator lights up in the front panel display, and the display returns to the selected sound field program.

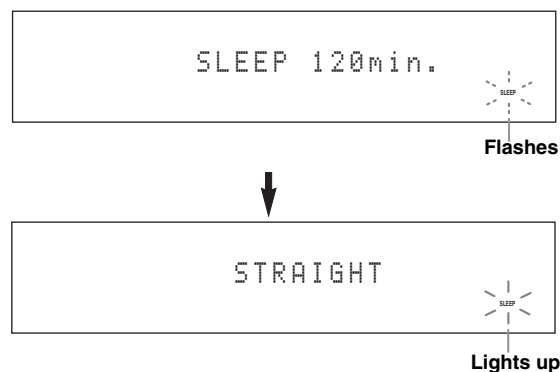

Canceling the sleep timer

Press **SLEEP** (or **SLEEP**) repeatedly until “SLEEP OFF” appears in the front panel display.

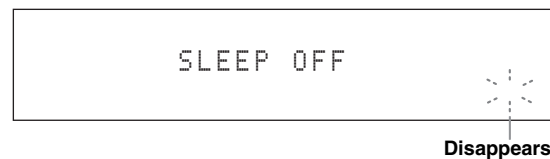

The SLEEP indicator turns off, and “SLEEP OFF” disappears from the front panel display after a few seconds.



The sleep timer setting can also be canceled by pressing **MAIN ZONE ON/OFF** (or **STANDBY**) to set the main zone to the standby mode.

Operating the amplifier functions of this unit by using the graphical user interface (GUI) screen

This unit features a sophisticated graphical user interface (GUI) screen that helps you to control the amplifier function of this unit. With the GUI screen, you can view the information of the signals being input and the status of this unit. You can also set up this unit using the GUI screen (see page 73).

■ Items in GUI screen

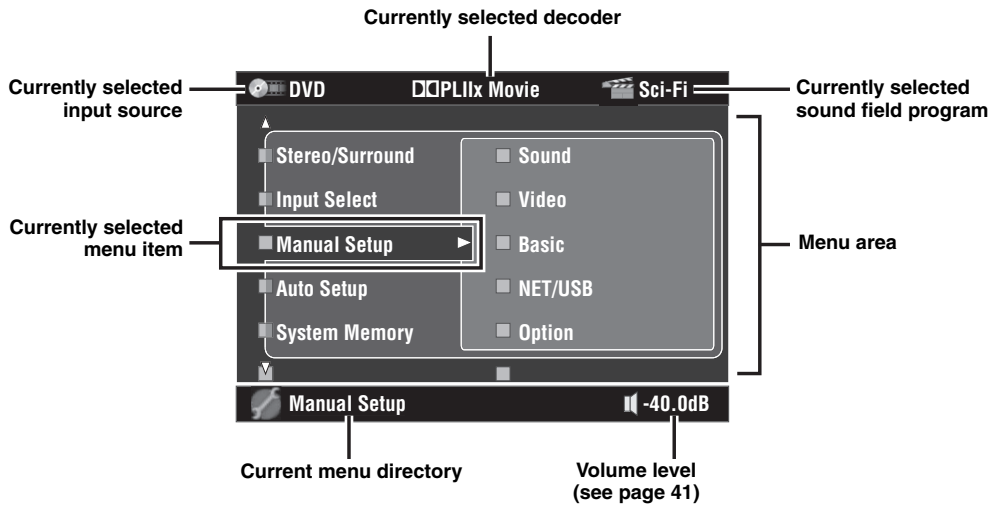

- Set the operation mode selector to **AMP** when you operate this unit by using GUI screen.
- See page 73 for details about the contents in the menu area.
- This unit reserves the previously selected GUI screen.

■ Basic controls in the GUI screen

button	feature
④ Cursor Δ / ∇	Press to select the item in the current menu level.
④ Cursor \triangleright	Press to select the currently selected menu item and move to the next menu level.
④ Cursor \triangleleft	Press to return to the previous menu level.
④ ENTER	Press to select the currently selected menu item and move to the next menu level.
⑰ SET MENU	Press to display or turn off the GUI screen.

Sound field programs

This unit is equipped with a variety of precise digital decoders that allow you to enjoy multi-channel playback from almost any stereo or multi-channel sound source. This unit is also equipped with a Yamaha digital sound field processing (DSP) chip containing several sound field programs which you can use to enhance your playback experience.



- The Yamaha CINEMA DSP sound field program are compatible with all Dolby Digital, DTS, Dolby Surround, Dolby TrueHD, and DTS-HD Master Audio sources.
- The Yamaha HiFi DSP sound field programs recreate real-world acoustic environments made from precise measurements taken in actual concert halls, music venues, movie theaters, etc. Thus, you may notice variations in the strength of the reflections coming from the front, back, left and right.

Selecting sound field programs

Rotate the **PROGRAM** selector (or set the operation mode selector to **AMP** and then press one of the sound field selector buttons repeatedly).

The name of the selected sound field program appears in the front panel display and in the short message display.

Notes

- When you select an input source, this unit automatically selects the last sound field program used with the corresponding input source.
- Sound field programs cannot be selected when the component connected to the MULTI CH INPUT jacks is selected as the input source (see page 42) or when this unit is in the Pure Direct mode (see page 51).
- When you play back DTS 96/24 sources with any sound field program, this unit applies the selected program without activating the DTS 96/24 decoder.
- Sampling frequencies higher than 48 kHz are sampled down to 48 kHz or lower and then sound field programs are applied.



You can select the desired sound field programs and setting the parameters by using GUI screen. See page 74 for details.

Sound field program descriptions



Select a sound field program based on your listening preference, not merely on the name of the program, etc.

Remote control button	Category of the program	Name of the program	Created sound fields	CINEMA DSP or HiFi DSP
	MOVIE	Sci-Fi		
This program clearly reproduces the finely elaborated sound design of the latest science fiction and special effects-featuring movies. You can enjoy a variety of cinematographically created virtual spaces reproduced with clear separation between dialog, sound effects and background music.				
Decoder Type DSP Level	Init. Delay Room Size	Sur. Init. Delay Sur. Room Size	SB. Init. Delay SB. Room Size	Dialogue Lift
Available sound field parameters (see page 76)				Program description

Sound field indicators

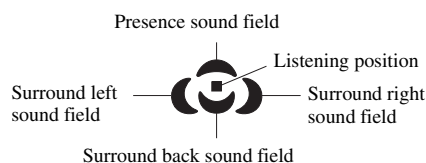



■ **For audio music sources**



For audio music sources, we also recommend using the Pure Direct mode (see page 51), the “STRAIGHT” mode (see page 50) or surround decode mode (see page 71).



CLASSICAL 5	CLASSICAL	Hall in Munich		HiFi DSP
This sound field simulates a concert hall with approximately 2500 seats in Munich, using stylish wood for the interior finishing as normal standards for European concert halls. Fine, beautiful reverberations spread richly, creating a calming atmosphere. The listener's virtual seat is at the center left of the arena.				
DSP Level Init. Delay	Room Size Liveness	Dialogue Lift		
CLASSICAL 5	CLASSICAL	Hall in Vienna		HiFi DSP
This is an approximately 1700-seated, middle-sized concert hall with a shoebox shape that is traditional in Vienna. Pillars and ornate carvings create extremely complex reflections from all around the audience, producing a very full, rich sound.				
DSP Level Init. Delay	Room Size Liveness	Dialogue Lift		
CLASSICAL 5	CLASSICAL	Hall in Amsterdam		HiFi DSP
The large, shoe box shaped hall seats about 2200 around the circle stage. Reflections are rich and pleasing while the sound travels freely.				
DSP Level Init. Delay	Room Size Liveness	Dialogue Lift		
CLASSICAL 5	CLASSICAL	Church in Freiburg		HiFi DSP
Located in the south of Germany, this grand, stone-built church has a pointed tower at 120 meters in height. Its long and narrow shape and the high ceiling enable the elongated reverberation time and limited initial reflection time. Thus, the rich reverberation rather than the sound itself reproduces the atmosphere of the church.				
DSP Level Init. Delay	Liveness Rev. Time	Rev. Delay Rev. Level	Dialogue Lift	
CLASSICAL 5	CLASSICAL	Chamber		HiFi DSP
This program creates a relatively wide space with a high ceiling like an audience hall in a palace. It offers pleasant reverberations that are suitable for courtly music and chamber music.				
DSP Level Init. Delay	Liveness Rev. Time	Rev. Delay Rev. Level	Dialogue Lift	
LIVE/CLUB 6	LIVE/CLUB	Village Vanguard		HiFi DSP
The Jazz club is on 7th Avenue, New York. This small club with the low ceiling makes the powerful reflections converge toward the stage located in the corner.				
DSP Level Init. Delay	Room Size Liveness	Dialogue Lift		
LIVE/CLUB 6	LIVE/CLUB	Warehouse Loft		HiFi DSP
The warehouse resembles some lofts in Soho. Sound reflects off the concrete walls clearly with a lot of energy.				
DSP Level Init. Delay	Room Size Liveness	Rev. Time Rev. Delay	Rev. Level Dialogue Lift	

LIVE/CLUB 6	LIVE/CLUB	Cellar Club		HiFi DSP
This program simulates a live house with a low ceiling and homey atmosphere. A realistic, live sound field features powerful sound as if the listener is in a row in front of a small stage.				
DSP Level Init. Delay	Room Size Liveness	Dialogue Lift		
LIVE/CLUB 6	LIVE/CLUB	The Roxy Theatre		HiFi DSP
This is the sound field of a rock music live house in Los Angeles, with approximately 460 seats. The listener's virtual seat is at the center left of the hall.				
DSP Level Init. Delay	Room Size Liveness	Rev. Time Rev. Delay	Rev. Level Dialogue Lift	
LIVE/CLUB 6	LIVE/CLUB	The Bottom Line		HiFi DSP
This is the sound field at stage front in The Bottom Line, a famous New York jazz club. The floor can seat 300 people to the left and right in a sound field offering real and vibrant sound.				
DSP Level Init. Delay	Room Size Liveness	Dialogue Lift		

■ For various sources

Note



The available sound field parameters and the created sound fields differ depending on the input sources and the settings of this unit.



ENTERTAIN 7	ENTERTAINMENT	Sports		CINEMA DSP
This program allows the listeners to enjoy stereo sport broadcasts and studio variety programs with enriched live feeling. In sports broadcasts, the voices of the commentator and sportscaster are positioned clearly on the center while the atmosphere of the stadium expands in an optimum space to offer the listeners with a feeling of presence in the stadium.				
DSP Level Init. Delay	Room Size Sur. Init. Delay	Sur. Room Size SB. Init. Delay	SB. Room Size Dialogue Lift	
ENTERTAIN 7	ENTERTAINMENT	Action Game		CINEMA DSP
This sound field is suitable for action games such as car racing and FPS games. It uses the reflection data that limits the effects range per channel in order to offer a powerful playing environment with a being-there feeling by enhancing various effects tones while maintaining a clear sense of directions.				
DSP Level Init. Delay	Room Size Sur. Init. Delay	Sur. Room Size SB. Init. Delay	SB. Room Size Dialogue Lift	
ENTERTAIN 7	ENTERTAINMENT	Roleplaying Game		CINEMA DSP
This sound field is suitable for role-playing and adventure games. It combines the sound field effects for movies and the sound field design used with "Action Game" to represent the depth and 3D feeling of the field during play, while offering movie-like surround effects in the movie scenes in the game.				
DSP Level Init. Delay	Room Size Sur. Init. Delay	Sur. Room Size SB. Init. Delay	SB. Room Size Dialogue Lift	

■ For visual sources of music

Note

The available sound field parameters and the created sound fields differ depending on the input sources and the settings of this unit.

	ENTERTAINMENT	Music Video		
This sound field offers an image of a concert hall for live performance of pop, rock and jazz music. The listener can indulge oneself in a hot live space thanks to the presence sound field that emphasizes the vividness of vocals and solo play and the beat of rhythm instruments, and to the surround sound field that reproduces the space of a big live hall.				
DSP Level Init. Delay	Room Size Sur. Init. Delay	Sur. Room Size SB. Init. Delay	SB. Room Size Dialogue Lift	

	ENTERTAINMENT	Recital/Opera		
This program controls the amount of reverberations at an optimum level and emphasizes the depth and clarity of human voices. “Opera” offers the reverberations of an orchestra box in front of the listener at the same time as providing the acoustic positioning and feeling of presence on the stage. The surround sound field is relatively moderate, but the data for concert hall effects are used to represent the inherent beauty of music. The listener will not be fatigued even after long hours of opera entertainment.				
DSP Level Init. Delay	Room Size Sur. Init. Delay	Sur. Room Size SB. Init. Delay	SB. Room Size Dialogue Lift	



■ For movie sources









You can select the desired decoder used with following sound field program (except “Mono Movie”). See page 71 for details.



Note



The available sound field parameters and the created sound fields differ depending on the input sources and the settings of this unit.



	MOVIE	Standard		
This program create a sound field emphasizing the surrounding feeling without disturbing the original acoustic positioning of multi-channel audio such as Dolby Digital and DTS. It has been designed with the concept of “an ideal movie theater”, in which the audience is surrounded by beautiful reverberations from the left, right and rear.				
Decoder Type DSP Level	Sur. Init. Delay Sur. Room Size	Sur. Liveness SB. Init. Delay	SB Room Size SB Liveness	Dialogue Lift

	MOVIE	Spectacle		
This program represents the spectacular feeling of large-scale movie productions. It reproduces a broad theater sound field matching the cinemascope and wider-screen movies with an excellent dynamic range from very small to extremely large sound.				
Decoder Type DSP Level	Init. Delay Room Size	Sur. Init. Delay Sur. Room Size	SB. Init. Delay SB. Room Size	Dialogue Lift



	MOVIE	Sci-Fi		
This program clearly reproduces the finely elaborated sound design of the latest science fiction and special effects-featuring movies. You can enjoy a variety of cinematographically created virtual spaces reproduced with clear separation between dialog, sound effects and background music.				
Decoder Type DSP Level	Init. Delay Room Size	Sur. Init. Delay Sur. Room Size	SB. Init. Delay SB. Room Size	Dialogue Lift

	MOVIE	Adventure		
<p>This program is ideal for precisely reproducing the sound design of action and adventure movies. The sound field restrains reverberations but puts emphasis on reproducing a powerful space expanded widely to the left and right. The reproduced depth is also restrained relatively to ensure the separation between audio channels and the clarity of the sound.</p>				
Decoder Type	Init. Delay	Sur. Init. Delay	SB. Init. Delay	Dialogue Lift
DSP Level	Room Size	Sur. Room Size	SB. Room Size	

	MOVIE	Drama		
<p>This sound field features stable reverberations that match a wide range of movie genres from serious dramas to musicals and comedies. The reverberations are modest but offer an optimum 3D feeling, reproducing effects tones and background music softly but cubically around clear words and center positioning in a way that does not fatigue the listener even after long hours of viewing.</p>				
Decoder Type	Init. Delay	Sur. Init. Delay	SB. Init. Delay	Dialogue Lift
DSP Level	Room Size	Sur. Room Size	SB. Room Size	

	MOVIE	Mono Movie		
<p>This program is provided for reproducing monaural video sources such as a classic movie in an atmosphere of a good old movie theater. The program produces the optimum expansion and reverberation to the original audio to create a comfortable space with a certain sound depth.</p>				
DSP Level	Room Size	Rev. Time	Rev. Delay	
Init. Delay	Liveness	Rev. Level	Dialogue Lift	

■ Stereo playback

	STEREO	2ch STEREO		
<p>Use this program to mix down multi-channel sources to 2 channels. See page 52 for details.</p>				
Direct				

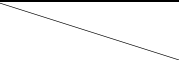
	STEREO	7ch STEREO		HiFi DSP
<p>Use this program to output sound from all speakers. When you play back multi-channel sources, this unit downmixes the source to 2 channels, and then output the sound from all speakers. This program creates a larger sound field and is ideal for background music at parties, etc.</p>				
Center Level	Surround R Level	Presence L Level		
Surround L Level	Sur. Back Level	Presence R Level		

■ The Compressed Music Enhancer

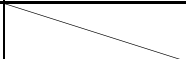
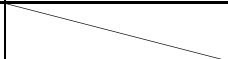
	MUSIC ENHANCER	Straight Enhancer		
<p>Use this program to improve the sound enhancer nearest to the original depth and width of the 2-channel or multi-channel compression artifacts.</p>				
Level				

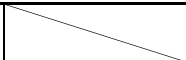
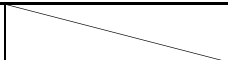
	MUSIC ENHANCER	7ch Enhancer		
<p>Use this program to play back compression artifacts in 7-channel stereo.</p>				
Level				

■ Using sound field programs without surround speakers (Virtual CINEMA DSP)

Virtual CINEMA DSP allows you to enjoy the CINEMA DSP or HiFi DSP sound field programs without surround speakers. It creates virtual speakers to reproduce the natural sound field.

When you set “Surround” to “None” (see page 92), Virtual CINEMA DSP activates automatically whenever you select a CINEMA DSP or HiFi DSP sound field program (see page 45).

Note

Virtual CINEMA DSP will not activate even when “Surround” is set to “None” (see page 92) in the following cases:

- when the component connected to the MULTI CH INPUT jacks is selected as the input source (see page 42).
- when headphones are connected to the PHONES jack.
- when this unit is in the “7ch stereo” mode.

■ Enjoying multi-channel sources and sound field programs with headphones (SILENT CINEMA)

SILENT CINEMA allows you to enjoy multi-channel music or movie sound through ordinary headphones. SILENT CINEMA activates automatically whenever you connect headphones to the PHONES jack while listening to CINEMA DSP or HiFi DSP sound field programs (see page 45). When activated, the SILENT CINEMA indicator lights up in the front panel display.

Notes

- SILENT CINEMA does not activate when the component connected to the MULTI CH INPUT jacks is selected as the input source (see page 42).
- SILENT CINEMA is not effective when the Pure Direct (see page 51) or “2ch Stereo” mode (see page 52) is selected, or when this unit is in the “STRAIGHT” mode.

Before performing the following operation, set the operation mode selector on the remote control to **AMP**.

Using CINEMA DSP 3D mode

CINEMA DSP 3D mode creates the intensive and accurate stereoscopic sound field in the listening room. You can activate and deactivate the CINEMA DSP 3D mode.

Press **3D DSP repeatedly to turn on and off the CINEMA DSP 3D mode.**

- “3D:ON” appears in the front panel display and the 3D indicator (see page 36) lights up while this unit is in the CINEMA DSP 3D mode. CINEMA DSP 3D mode creates the intensive and stereoscopic sound field in the listening room.
- “3D:OFF” appears in the front panel display and the 3D indicator disappears when the CINEMA DSP 3D mode is turned off. Conventional CINEMA DSP mode creates the large and expanding sound field in the listening room.

Notes

- “3D:—” appears when the CINEMA DSP 3D mode is not available.
- If you set “Presence” to “None”, this unit cannot activate the CINEMA DSP 3D mode.
- This unit activates the CINEMA DSP 3D mode only when you select one of the CINEMA DSP or HiFi DSP sound field programs.
- When your headphones are connected to this unit, this unit cannot activate the CINEMA DSP 3D mode.

Enjoying unprocessed input sources

When this unit is in the “STRAIGHT” mode, 2-channel stereo sources are output from only the front left and right speakers. Multi-channel sources are decoded straight into the appropriate channels without any additional effect processing.



You can also select the “STRAIGHT” mode by using GUI screen. See page 74 for details.

Press **STRAIGHT (or **STRAIGHT**) to select “STRAIGHT”.**

STRAIGHT



The names of the audio signal format of the input source and the active decoder appear in the front panel display.

■ Deactivating the “STRAIGHT” mode

Press **STRAIGHT (or **STRAIGHT**) so that “STRAIGHT” disappears from the front panel display.**

The sound effect is turned back on.



You can also select desired sound field program by rotating the **PROGRAM** selector (or press one of the desired sound field program buttons (**PROGRAM**)) repeatedly.

Using audio features

Before performing the following operation, set the operation mode selector on the remote control to **AMP**.

Enjoying pure hi-fi sound

Use the Pure Direct mode to enjoy the pure fidelity sound of the selected source. When the Pure Direct mode is activated, this unit plays back the selected source with the least circuitry.

Press **PURE DIRECT** (or **PURE DIRECT**) to turn on or off the Pure Direct mode.

The **PURE DIRECT** button on the front panel lights up and the front panel display automatically turns off while this unit is in the Pure Direct mode.

Notes

- When this unit is in the Pure Direct mode, this unit does not output any video signals at the MONITOR OUT jacks and the HDMI OUT jack.
- When you set Audio input jack selects to “AUTO”, “HDMI”, or “COAX/OPT” (see page 42) and play back the bitstreams or multi-channel PCM sources, this unit activates the corresponding decoder.
- The following operations are not possible when this unit is in the Pure Direct mode:
 - switching the sound field program
 - displaying the GUI screen
 - operating video functions (video conversion, etc.)
- The Pure Direct mode is automatically canceled whenever this unit is turned off.



The front panel display turns on momentarily when an operation is performed.

Adjusting the tonal quality

Use this feature to adjust the balance of bass and treble for the front L/R and center speaker channels and the subwoofer channel.

1 Press **TONE CONTROL** on the front panel repeatedly to select the high-frequency response (**TREBLE**) or the low-frequency response (**BASS**).

2 Rotate the **PROGRAM** selector to adjust the high-frequency response (**TREBLE**) or the low-frequency response (**BASS**).

Control range: -6.0 dB to +6.0 dB

Notes

- If you increase or decrease the high-frequency or the low-frequency sound to an extreme level, the tonal quality of the surround speakers may not match that of the front L/R and center speakers and the subwoofer.
- **TONE CONTROL** is not effective when **PURE DIRECT** is selected, or when **MULTI CH** is selected as the input source.



Use “Tone Control” parameter in “Sound” menu to adjust the balance of bass and treble output to your speakers or headphones by using GUI screen. See page 86 for details.

Before performing the following operation, set the operation mode selector on the remote control to **AMP**.

Adjusting the speaker level

You can adjust the output level of each speaker while listening to a music source. This is also possible when playing sources input at the MULTI CH INPUT jacks.

Note

This operation will override the level adjustments made in “Auto Setup” (see page 37) and “Speaker Level” (see page 94).

1 Press **LEVEL** on the front panel repeatedly to select the speaker you want to adjust.

Display	Adjusted speaker
FRONT L	Front left speaker
CENTER	Center speaker
FRONT R	Front right speaker
SUR. R	Surround right speaker
SB R	Surround back right speaker
SB L	Surround back left speaker
SUR. L	Surround left speaker
SWFR	Subwoofer
PRNS L	Presence left speaker
PRNS R	Presence right speaker



- Once you press **LEVEL** on the remote control, you can also select the speaker by pressing **Δ / ▽**.
- Instead of “SB R” and “SB L”, “SB” is displayed if “Surround Back” is set to either “Small x1” or “Large x1” (see page 92).

2 Press **◀ / ▶** to adjust the speaker output level.

- Press **▶** to increase the value.
- Press **◀** to decrease the value.

Control range: -10.0 dB to +10.0 dB

Enjoying multi-channel sources in 2-channel stereo

You can mix down multi-channel sources to 2 channels and enjoy playback in 2-channel stereo.

Press **STEREO** on the remote control repeatedly to select “2ch Stereo”.



- You can use a subwoofer with this program when “Bass Out” is set to “SWFR” or “Both” (see page 92).
- You can also select the “2ch Stereo” mode by rotating the **PROGRAM** selector on the front panel.
- You can also select the “2ch Stereo” mode and adjust the parameter by using GUI screen. See page 74 for details.
- See page 79 for details about the parameters of the “2ch Stereo” mode.

FM/AM tuning

There are 2 tuning methods: automatic and manual. Automatic tuning is effective when station signals are strong and there is no interference. If the signal from the station you want to select is weak, tune into it manually. You can also use the automatic and manual preset tuning features to store up to 40 stations (A1 to E8: 8 preset station numbers in each of the 5 preset station groups). Furthermore, you can recall any preset stations and exchange the assignment of two preset stations with each other.

Note

Orient the connected FM and AM antennas for the best reception.

Automatic tuning

Automatic tuning is effective when station signals are strong and there is no interference.

- 1 Rotate the **INPUT** selector on the front panel to select “TUNER” as the input source.
- 2 Press **FM/AM** to select the reception band. “FM” or “AM” appears in the front panel display.
- 3 Press **TUNING MODE** so that the **AUTO** indicator lights up in the front panel display.

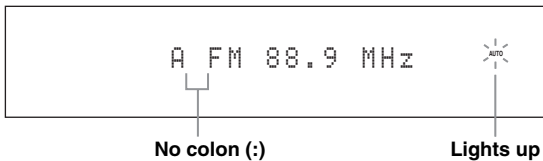

If a colon (:) appears in the front panel display, tuning is not possible. Press **PRESET/TUNING** to turn the colon (:) off.

- 4 Press **PRESET/TUNING/CH** $\triangleleft/\triangleright$ once to begin automatic tuning.

When this unit is tuned into a station, the **TUNED** indicator lights up and the frequency of the received station is shown in the front panel display.

- Press **PRESET/TUNING/CH** \triangleright to tune into a higher frequency.
- Press **PRESET/TUNING/CH** \triangleleft to tune into a lower frequency.

Manual tuning

If the signal received from the station you want to select is weak, tune into it manually.

Note

Manually tuning into an FM station automatically switches the tuner to monaural reception to increase the signal quality.

- 1 Rotate the **INPUT** selector on the front panel to select “TUNER” as the input source.
- 2 Press **FM/AM** to select the reception band. “FM” or “AM” appears in the front panel display.
- 3 Press **TUNING MODE** so that the **AUTO** indicator disappears from the front panel display.

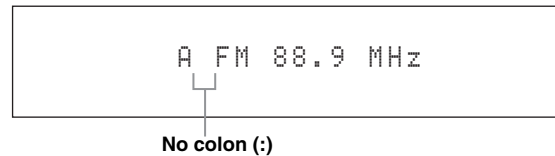

If a colon (:) appears in the front panel display, tuning is not possible. Press **PRESET/TUNING** to turn the colon (:) off.

- 4 Press **PRESET/TUNING/CH** $\triangleleft/\triangleright$ to tune into the desired station manually. Hold down the button to continue searching.

Automatic preset tuning

You can use the automatic preset tuning feature to store up to 40 FM stations with strong signals (A1 to E8: 8 preset station numbers in each of the 5 preset station groups) in order. You can then recall any preset station easily by selecting the preset station number.

1 Rotate the **Ⓢ INPUT selector on the front panel to select “TUNER” as the input source.**

2 Press **Ⓜ FM/AM to select “FM” as the reception band.**

“FM” appears in the front panel display.

3 Press and hold **Ⓜ MEMORY for more than 3 seconds.**

The preset station number as well as the AUTO and MEMORY indicators flashes. After approximately 10 seconds, automatic presetting starts from the current frequency and proceeds toward higher frequencies.



When automatic preset tuning is completed, the front panel display shows the frequency of the last preset station.



- You can specify the preset number from which this unit stores FM stations. Press **Ⓜ** A/B/C/D/E and then **Ⓜ** PRESET/TUNING/CH **◀/▶** repeatedly after you perform step 3 to select the preset station number under which the first station will be stored.
- You can begin tuning toward lower frequencies to store FM stations automatically. Press **Ⓜ** PRESET/TUNING so that the colon (:) disappears from the front panel display and then press **Ⓜ** PRESET/TUNING/CH **◀** after pressing and holding **Ⓜ** MEMORY for more than 3 seconds.

Notes

- Any stored station data existing under a preset station number is cleared when you store a new station under the same preset station number.
- If the number of received stations does not reach 40 (E8), automatic preset tuning automatically stops after searching for all the available stations.
- Only FM stations with sufficient signal strength are stored automatically by automatic preset tuning. If the station you want to store is weak in signal strength, tune into it manually and store it as described in “Manual preset tuning”.
- (Europe model only) Only Radio Data System broadcasting station are stored automatically by automatic preset tuning.

Manual preset tuning

You can also store up to 40 stations (A1 to E8: 8 preset station numbers in each of the 5 preset station groups) manually.

1 Tune into a station automatically or manually.

See page 53 for tuning instructions.

2 Press **Ⓜ MEMORY.**

The MEMORY indicator flashes in the front panel display for approximately 10 seconds.

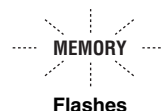

3 Press **Ⓜ A/B/C/D/E repeatedly to select a preset station group (A to E) while the MEMORY indicator is flashing.**

The selected preset station group letter appears.

Check that the colon (:) appears in the front panel display.

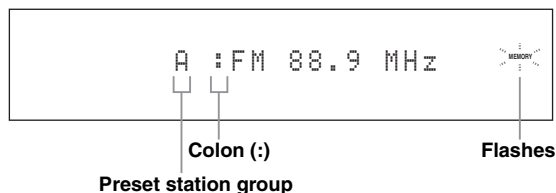

4 Press **Ⓜ PRESET/TUNING/CH **◀/▶** to select a preset station number (1 to 8) while the MEMORY indicator is flashing.**

- Press **Ⓜ** ▶ to select a higher preset station number.
- Press **Ⓜ** ◀ to select a lower preset station number.

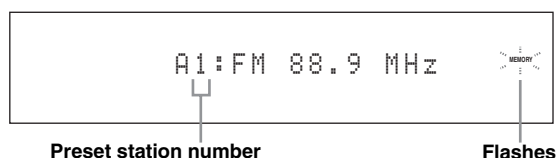

5 Press **ⓄMEMORY** while the MEMORY indicator is flashing.

The station band and frequency appear in the front panel display with the preset station group and number you have selected. The MEMORY indicator disappears from the front panel display.



The displayed station has been stored as A1.

Notes

- Any stored station data existing under a preset station number is cleared when you store a new station under the same preset station number.
- The reception mode (stereo or monaural) is stored along with the station frequency.

Selecting preset stations

You can tune into any desired station simply by selecting the preset station group and number under which it was stored.

Set the operation mode selector to **ⓄSOURCE** and then press **ⓂTUNER** to select "TUNER" as the input source.

1 Press **ⓄA/B/C/D/E** (or **ⓄA-E/CAT.** $\triangleleft/\triangleright$) to select the desired preset station group (A to E).

The preset station group letter appears in the front panel display and changes each time you press the button.

2 Press **ⓂPRESET/TUNING/CH** $\triangleleft/\triangleright$ (or **ⓄPRESET/CH** \triangle/∇) to select the desired preset station number (1 to 8).

The preset station group and number appear in the front panel display along with the station band and frequency.

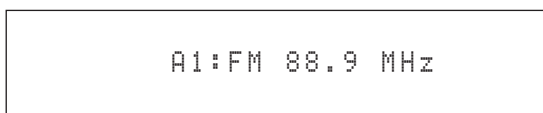

Exchanging preset stations

You can exchange the assignments of two preset stations with each other. The example below describes the procedure to exchange preset station "E1" with "A5".

1 Select preset station "E1" using **ⓄA/B/C/D/E** and **ⓂPRESET/TUNING/CH** $\triangleleft/\triangleright$ on the front panel.

See "Selecting preset stations" on left column.

2 Press and hold **ⓂEDIT** for more than 3 seconds.

"E1" and the MEMORY indicator flash in the front panel display.

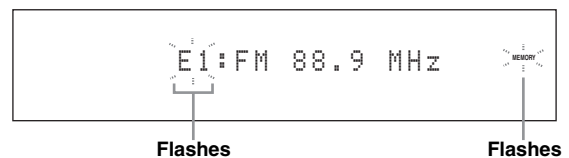

3 Select preset station "A5" using **ⓄA/B/C/D/E** and **ⓂPRESET/TUNING/CH** $\triangleleft/\triangleright$.

"A5" and the MEMORY indicator flash in the front panel display.

See "Selecting preset stations" on left column.

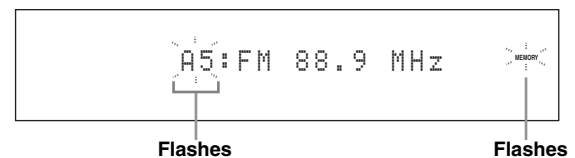

4 Press **ⓂEDIT** again.

"EDIT E1-A5" appears in the front panel display and the assignments of the two preset stations are exchanged.



XM™ Satellite Radio tuning

XM Satellite Radio offers an extraordinary variety of commercial-free music, plus the best in sports, news, talk and entertainment. XM is broadcast in superior digital audio from coast to coast. From rock to reggae, from classical to hip hop, XM has something for every music fan. XM's dedication to playing the richest selection of music is matched by its passion for live sporting events, talk radio, up-to-the-minute news, stand-up comedy, children's programming, and much more.

XM Satellite Radio online information

For U.S. customers: <http://www.xmradio.com/>

For Canadian customers: <http://www.xmradio.ca/>

Note

The XM Satellite Radio service is only available in the 48 contiguous United States (not available in Alaska and Hawaii) and Canada.

XM READY legal disclaimer

Hardware and required monthly subscription sold separately. Other fees and taxes, including a one-time activation fee may apply. Subscription fee is consumer only. All fees and programming subject to change. Channels with frequent explicit language are indicated with an XL. Channel blocking is available for XM radio receivers by calling 1-800-XMRADIO (US residents) and 1-877-GET-XMSR (Canadian residents). For a full listing of the XM commercial-free channels and advertising-supported channels, visit lineup.xmradio.com (US residents) or www.xmradio.ca (Canadian residents). Subscriptions subject to Customer Agreement available at xmradio.com (US residents) and xmradio.ca (Canadian residents). Service only available in the 48 contiguous United States and Canada. ©2007 XM Satellite Radio Inc. All rights reserved. All other trademarks are the property of their respective owners.

■ Enjoying XM HD Surround content

This unit is equipped with the Neural-THX Surround decoder that plays back the XM HD surround sound content of the XM Satellite Radio broadcasts in multi-channels, resulting in a full surround sound experience (see page 72).

Connecting the XM™ Mini-Tuner Home Dock

Connect XM Mini-Tuner and Home Dock (each sold separately) to the XM jack on the rear panel of this unit. For information on your XM Mini-Tuner and Home Dock, see the operating instructions provided with XM Mini-Tuner Dock.

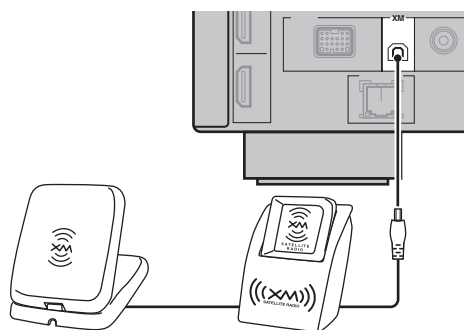

XM Mini-Tuner and
XM Home Dock (sold separately)



- To ensure optimal reception of the XM Satellite Radio signals, the antenna of Home Dock must be placed at or near a south-facing window with no obstacles in the path to the sky. You can mount it indoors or outdoors.
- Use the "Antenna Level" parameter of "XM" in "Input Select" (see page 81) to display the XM Satellite Radio reception level on the video monitor. For the best reception, adjust the orientation of the antenna of connected Home Dock so that a value of 60% or more is displayed.

Note

If "CHECK ANTENNA" appears in the front panel display, Home Dock may not be connected to the XM jack on the rear panel of this unit properly.

Activating XM™ Satellite Radio

■ Checking your XM Radio ID

Once you have installed the XM Mini-Tuner Home Dock, inserted the XM Mini-Tuner, connected the Home Dock to your XM Ready home audio system, and installed the antenna, you are ready to subscribe and begin receiving XM programming. There are three places to find your eight character XM Radio ID: on the XM Mini-Tuner, on the XM Mini-Tuner package, and on XM Channel 0 (see page 58). Record the Radio ID in the following eight squares for reference.



Note

The XM Radio ID does not use the letters “I”, “O”, “S” or “F”.

■ Subscription of your XM Satellite Radio service

For U.S. customers

URL: <http://www.xmradio.com/>

Phone: 1-800-XM-RADIO (1-800-967-2346)

For Canadian customers

URL: <http://www.xmradio.ca/>

Phone (XM’s Listener Care):

1-877-GET-XMSR (1-877-438-9677)

Note

You will need a major credit card. XM will send a signal from the satellites to activate the full channel lineup. Activation normally takes 10 to 15 minutes, but during peak busy periods you may need to keep your XM Ready home audio system on for up to an hour. When you can access the full channel lineup on your XM Ready home audio system you are done.

Basic XM™ Satellite Radio operations

Before performing the following operations, set the operation mode selector on the remote control to **SOURCE**.

1 Rotate the **INPUT** selector (or press **XM**) to select “XM” as the input source.

The cursor on the left of the XM indicator lights up in the front panel display and the XM Satellite Radio information (such as channel number, channel name, category, artist name, or song title) for the currently selected channel appears in the front panel display.

Lights up

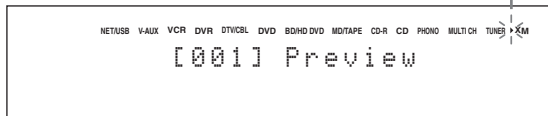

When you select “XM” as the input source, this unit automatically recalls the previously selected channel.

Note

The XM Satellite Radio signals cannot be output at the AUDIO OUT (REC) jacks.

2 Search for a channel by using one of the XM Satellite Radio search modes.

- To select a channel from the all channel list, see “All Channel Search mode” on page 58.
- To select a channel by category, see “Category Search mode” on page 58.
- To select a channel from the preset channels, see “Preset Search mode” on page 58.
- To select the desired channel directly by entering the channel number, see “Direct Number Access mode” on page 58.



- You can use the Neural-THX Surround decoder to enjoy the XM HD surround sound content of the XM Satellite Radio broadcasts in multi-channels (see page 72).
- You can set the XM Satellite Radio preset channels (see page 59).
- You can display the XM Satellite Radio information in the front panel display or in the OSD (see page 60).

Before performing the following operations, set the operation mode selector on the remote control to **④SOURCE** and then press **①XM**.

■ **All Channel Search mode**

- 1 Press **①SEARCH MODE** (or **⑰SRCH MODE**) repeatedly to select “ALL CH SEARCH”.

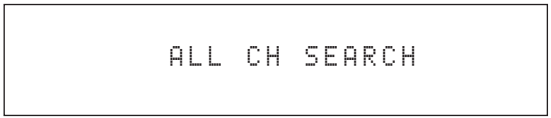

- 2 Press **⑥CATEGORY** (or **④A-E/CAT.** $\triangleleft/\triangleright$) repeatedly to change the channel category.

- 3 Press **⑨PRESET/TUNING/CH** $\triangleleft/\triangleright$ (or **④PRESET/CH** \triangle/∇) repeatedly to search for a channel within all channels.

You can search for a channel quickly by pressing and holding **⑨PRESET/TUNING/CH** $\triangleleft/\triangleright$ (or **④PRESET/CH** \triangle/∇).

■ **Category Search mode**

- 1 Press **①SEARCH MODE** (or **⑰SRCH MODE**) repeatedly to select “CAT SEARCH”.

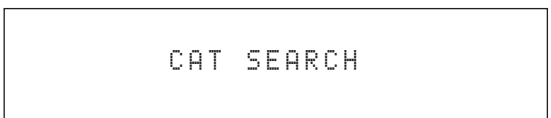

- 2 Press **⑥CATEGORY** (or **④A-E/CAT.** $\triangleleft/\triangleright$) repeatedly to change the channel category.

- 3 Press **⑨PRESET/TUNING/CH** $\triangleleft/\triangleright$ (or **④PRESET/CH** \triangle/∇) repeatedly to search for a channel within the selected channel category.

You can search for a channel quickly by pressing and holding **⑨PRESET/TUNING/CH** $\triangleleft/\triangleright$ (or **④PRESET/CH** \triangle/∇).

■ **Preset Search mode**

Prior to selecting a preset channel in the Preset Search mode, you must preset XM Satellite Radio channels. For details, see “Setting the XM™ Satellite Radio preset channels” on page 59.

The initial factory setting of all preset channels (A1 to E8) is “[001] Preview”.

- 1 Press **①SEARCH MODE** (or **⑰SRCH MODE**) repeatedly to select “PRESET SEARCH”.



- 2 Press **⑥CATEGORY** (or **④A-E/CAT.** $\triangleleft/\triangleright$) repeatedly to change the preset channel group (A to E).

- 3 Press **⑨PRESET/TUNING/CH** $\triangleleft/\triangleright$ (or **④PRESET/CH** \triangle/∇) repeatedly to change the preset channel number (1 to 8).

You can also select the preset channel number directly by pressing the numeric buttons (1 to 8) on the remote control.

■ **Direct Number Access mode**

- 1 Press **⑰SRCH MODE** on the remote control repeatedly to select “ALL CH SEARCH” or “CAT SEARCH”.



or



2 Press the numeric buttons (6) on the remote control to enter the desired three-digit channel number.

For example, to enter the number 123, press the numeric buttons as shown below.



The display changes as follows.

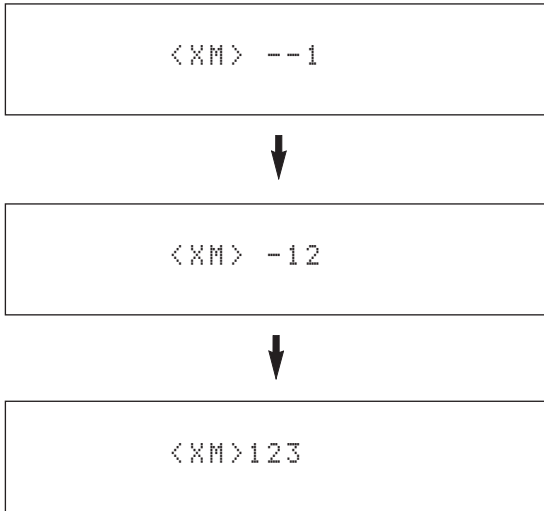

- To enter a one-digit or two-digit channel number, press the numeric buttons (6) on the remote control and then press (ENT) to confirm the input number.
- If no button is pressed within a few seconds after you enter a one-digit or two-digit number, this unit automatically confirms the entered channel number.
- Pressing a button other than the numeric buttons (6) or (ENT) cancels the Direct Number Access mode procedure.
- If you enter the number 0, this unit displays your XM Radio ID (see page 57).

Before performing the following operations, set the operation mode selector on the remote control to (SOURCE) and then press (XM).

Setting the XM™ Satellite Radio preset channels

You can use this feature to store up to 40 XM Satellite Radio channels (A1 to E8: 8 preset channel numbers in each of the 5 preset channel groups). You can then recall any preset channel easily by selecting the preset channel group and number as described in “Preset Search mode” on page 58.

1 Search for a channel you want to set as a preset channel by using one of the XM Satellite Radio search modes.

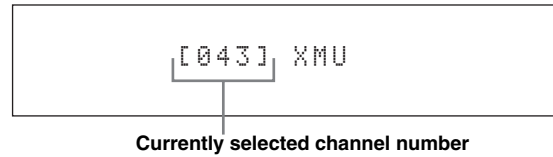

2 Press (MEMORY) (or (MEMORY)).

The MEMORY indicator flashes in the front panel display for approximately 5 seconds.

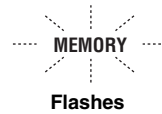

Note

You must proceed to and carry out steps 3 through 5 while the MEMORY indicator is flashing in the front panel display.

3 Press (CATEGORY) (or (A-E/CAT. </>)) repeatedly to select a preset channel group (A to E) while the MEMORY indicator is flashing.

The preset channel group letter appears in the front panel display.

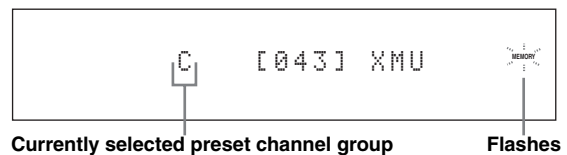

- 4 Press **Ⓜ** **PRESET/TUNING/CH** **◀/▶** (or **Ⓜ** **PRESET/CH** **▲/▼**) repeatedly to select a preset channel number (1 to 8) while the **MEMORY** indicator is flashing.

The preset channel number appears in the front panel display.

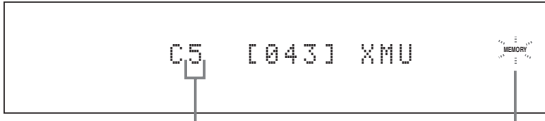

Currently selected preset channel number

Flashes

- 5 Press **Ⓜ** **MEMORY** (or **Ⓜ** **MEMORY**) to set the selected XM Satellite Radio channel as a preset channel while the **MEMORY** indicator is flashing.

A colon (:) appears next to the preset channel number for confirmation, and the **MEMORY** indicator turns off in the front panel display.

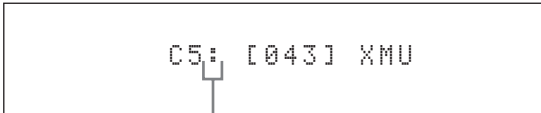

Colon (:)

Note

Once you set a new preset channel, the one previously stored in the same preset channel group and number is cleared.

Before performing the following operations, set the operation mode selector on the remote control to **Ⓜ** **SOURCE** and then press **Ⓜ** **XM**.

Displaying the XM™ Satellite Radio information

You can display the XM Satellite Radio information (such as channel number, channel name, category, artist name, or song title) for the currently selected channel in the front panel display or on the video monitor.

Note

If a status message or an error message appears in the front panel display or on the video monitor, see the “XM Satellite Radio (U.S.A. and Canada models only)” section in “Troubleshooting” on page 127 for appropriate remedies.

■ Displaying the XM Satellite Radio information in the front panel display

Press **Ⓜ** **DISPLAY** (or **Ⓜ** **DISPLAY**) repeatedly to toggle between the following XM Satellite Radio information display modes.

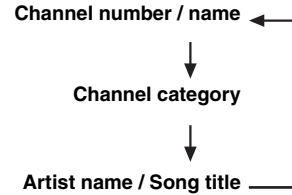

When the channel number / name is displayed:

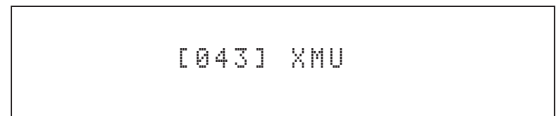

When the channel category is displayed:

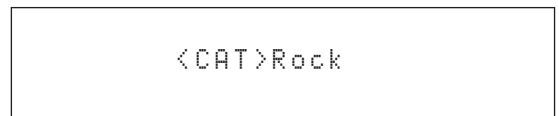

When the artist name / song title is displayed:

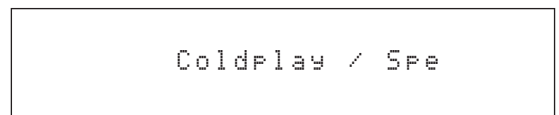

- You can set the front panel display mode by using the “Scroll” parameter in “Front Panel Disp.” (see page 96).
- If the XM Satellite Radio information contains a character that cannot be recognized by this unit, the character will be displayed with a space.

■ Displaying the XM Satellite Radio information on the video monitor

Press **Ⓛ** **DISPLAY** or **(@)** **DISPLAY**.

The following information screen is displayed on the video monitor.

XM Information		All CH Search
■ CH NUMBER	043	
■ CH NAME	XMU	
■ CATEGORY	Rock	
■ NAME	Coldplay	
■ TITLE	Speed of sound	
Hold : ENTER		



- To turn off the displayed information screen, press **Ⓛ** **DISPLAY** (or **(@)** **DISPLAY**).
- You can set the time for which the XM Satellite Radio information is displayed on the video monitor by using the “On Screen” parameter in “Manual Setup” (see page 90).
- To hold the XM Satellite Radio information screen, press **④** **ENTER** on the remote control while it is being displayed on the video monitor.
- The XM Satellite Radio information screen on hold is released if you press **④** **ENTER** on the remote control again or if you change the XM Satellite Radio channel.
- This unit can save up to two XM Satellite Radio information screens for future reference. To view the previous two XM Satellite Radio information screens, press **③** **TITLE** on the remote control repeatedly while the current XM Satellite Radio information screen is being hold.

Using iPod™

Once you have stationed your iPod in a Yamaha iPod universal dock (such as the YDS-10, sold separately) connected to the DOCK terminal of this unit (see page 30), you can enjoy playback of your iPod using the supplied remote control. You can also use the Compressed Music Enhancer mode of this unit to enhance the sound quality of the compression artifacts (such as the MP3 format) stored on your iPod (see page 49).

Notes

- Only iPod (Click and Wheel), iPod nano, and iPod mini are supported.
- Some features may not be compatible depending on the model or the software version of your iPod.



- For a complete list of status messages that appear in the front panel display and on the video monitor, see the “iPod” section in “Troubleshooting” on page 135.
- Once your iPod is stationed in a Yamaha iPod universal dock (such as the YDS-10, sold separately) connected to the DOCK terminal of this unit, this unit begins signal transmission with your iPod.
- Once the connection between your iPod and this unit is complete, “iPod connected” appears in the front panel display and the DOCK indicator lights up in the front panel display.
- Your iPod battery is automatically charged when your iPod is stationed in a Yamaha iPod universal dock (such as the YDS-10, sold separately) connected to the DOCK terminal of this unit as long as this unit is turned on. You can also select whether this unit charges the battery of the stationed iPod or not when this unit is in the standby mode by selecting the “Standby Charge” parameter in “iPod” (see page 96).
- While the stationed iPod is being charged in the standby mode of this unit, the battery charge indicator (see page 35) appears in the front panel display. Once the charge is complete (or after 4 hours from the start of the charge), the indicator disappears.

Controlling iPod™

You can control your iPod when “V-AUX” is selected as the input source. The operations of your iPod can be done with the aid of the GUI screen of this unit (menu browse mode) or without it (simple remote mode).

■ Remote control operation

Before performing the following operations, set the operation mode selector on the remote control to **④SOURCE** and then press **①V-AUX/DOCK**.

Button	Function
④ ENTER	Subsequent menu
△	Menu up
▽	Menu down
◀	Previous menu
▶	Subsequent menu
⑦ ◀◀	Search backward (Press and hold)
▶▶	Search forward (Press and hold)
▶▶▶	Skip forward
◀◀◀	Skip backward
□	Stop
⏏	Pause (Menu browse mode) Play/Pause (Simple remote mode)
▶	Play (Menu browse mode) Play/Pause (Simple remote mode)
⑰ MENU	Previous menu
⑳ DISPLAY	Display

■ Controlling iPod in the simple remote mode

You can perform the basic operations of your iPod (play, stop, skip, etc.) using the supplied remote control without the aid of the GUI screen of this unit.



- You can view the photos or video clips stored on your iPod.
- Operations can be also done with the controls on your iPod.

■ Controlling iPod in the menu browse mode

You can perform the advanced operations of your iPod using the supplied remote control with the aid of the GUI screen of this unit. The name of the song being played appears in the front panel display according to the “Scroll” parameter in “Front Panel Disp.” (see page 96). You can also browse the songs stored on your iPod in the GUI screen. Further, you can change or adjust settings for your iPod to suit your personal preferences.

Notes

- Operations cannot be done with the controls on your iPod.
- The Yamaha logo appears in the display window of your iPod.
- There are some characters that cannot be displayed in the front panel display or in the GUI screen of this unit. Those characters are replaced with underscores “_”.
- You cannot browse the photos or video clips stored on your iPod in the GUI screen. Use the simple remote mode to enjoy watching the photos or video clips stored on your iPod.
- You can set the time for which the GUI screen of iPod is displayed on the video monitor by using the “On Screen” parameter in “Manual Setup” (see page 90).

Before performing the following operations, set the operation mode selector on the remote control to **SOURCE** and then press **V-AUX/DOCK**.

1 Press **DISPLAY** on the remote control.

The following display appears in the video monitor.

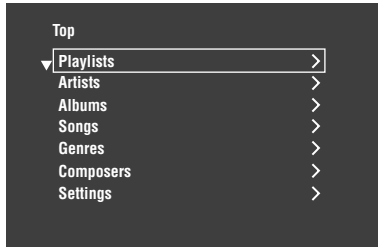

2 Press **UP/DOWN/LEFT/RIGHT** to navigate the iPod menu and then press **ENTER** to begin playback of the selected song.

Choices: Playlists (playlists), Artists (artists), Albums (albums), Songs (songs), Genres (genres), Composers (composers), Settings (settings)

- Playlists > Songs
- Artists > Albums > Songs
- Albums > Songs
- Songs
- Genres > Artists > Albums > Songs
- Composers > Albums > Songs
- Settings > Shuffle, Repeat

Shuffle (Shuffle)

Use this feature to set this unit to play songs or albums in random order.

Choices: Off, Songs, Albums

- Select “Off” to deactivate this feature.
- Select “Songs” to set this unit to play songs in random order.
- Select “Albums” to set this unit to play albums in random order.

Notes

- When “Shuffle” is set to a setting other than “Off”, “” appears in the top right corner while songs or albums are being shuffled.
- Press **ENTER** repeatedly to toggle between the settings of “Shuffle”.



Repeat (Repeat)

Use this feature to set this unit to repeat one song or a sequence of songs.

Choices: Off, One, All





- Select “Off” to deactivate this feature.
- Select “One” to set this unit to repeat one song.
- Select “All” to set this unit to repeat a sequence of songs.

Notes

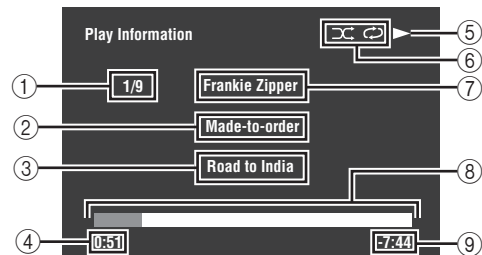
- When “Repeat” is set to a setting other than “Off”, “” or “” appears in the top right corner while one song or a sequence of songs are being repeated.
- Press **ENTER** repeatedly to toggle between the settings of “Repeat”.

The functions of the play information display



- 1 Track number/total tracks
- 2 Name of the album
- 3 Name of the song
- 4 Elapsed time
- 5  (playback),  (pausing),  (search forward) or  (search backward)
- 6 Shuffle and repeat icons
- 7 Name of the artist
- 8 Progress bar
- 9 Remaining time

Using Network/USB features

This unit is equipped with network and USB features that allow you to enjoy WAV (PCM format only), MP3 and WMA files saved on your PC, Yamaha MCX-2000, USB memory device and USB portable audio player or access the Internet Radio.

Notes

- Yamaha MCX-2000 may not be for sale in some locations.
- For further details about networking, refer to the operation manuals supplied with your network devices. Also refer to technical reference books, if needed.
- Some WAV, MP3 and WMA files may not be playable or may be noisy when played.



- For a complete list of the remote control functions used to control the network and USB features, refer to the “Remote control operation” on page 65.
- For a complete list of status messages that appear in the front panel display and on the video monitor, see the “Network and USB” section in “Troubleshooting” on page 132.

Navigating the network and USB menus

The following diagram shows the construction of the network and USB menu.

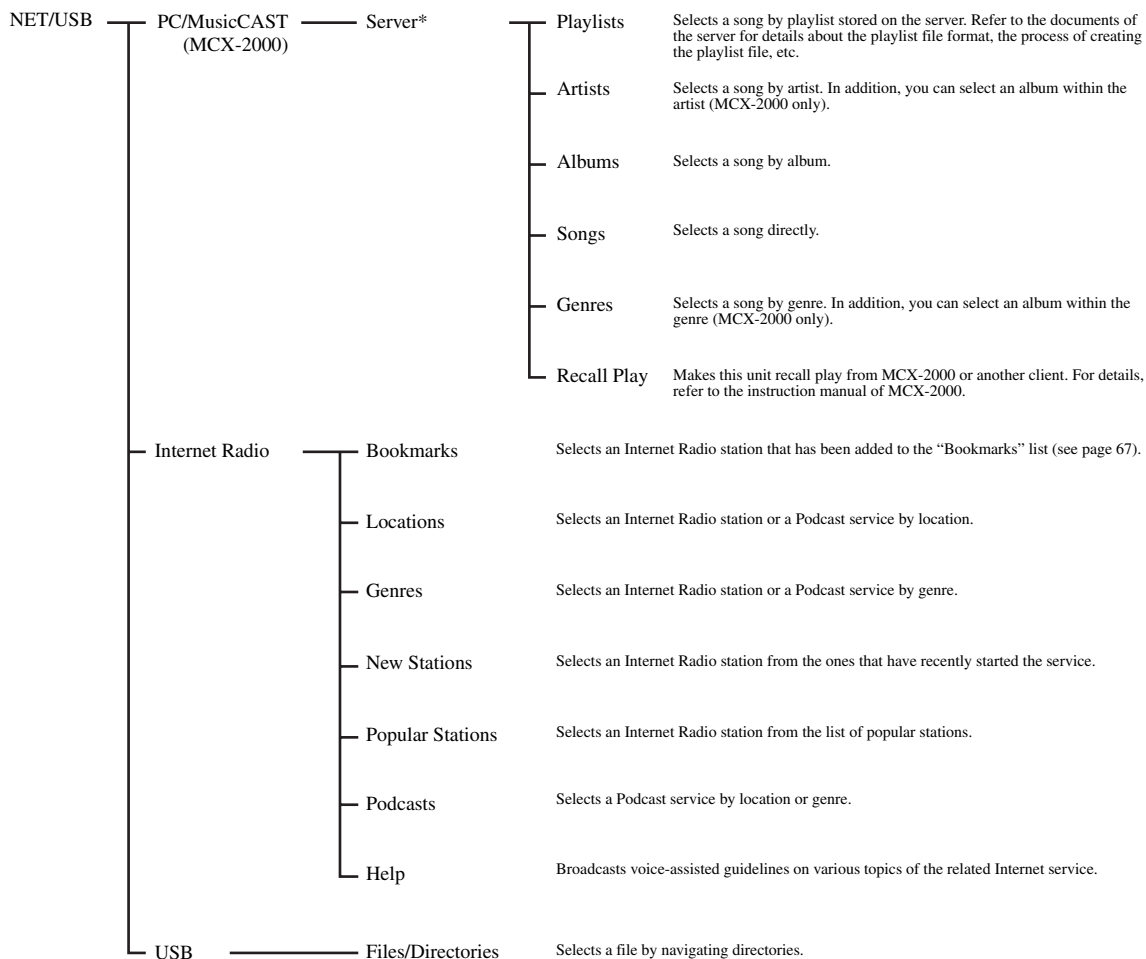

Note

* Only the available PC servers and MCX-2000 are displayed.

The following procedure shows the basic steps to navigate the network and USB menus. See pages 66 to 68 for details about each sub input source.

Note

“Please wait” may appear whenever it takes time for communication. This is not a system malfunction. Wait for a while.

Before performing the following operations, set the operation mode selector on the remote control to **④SOURCE**.

1 Press **①NET/USB** on the remote control to select “NET/USB” as the input source.

The cursor on the left of the NET/USB indicator lights up in the front panel display, and the contents previously played for the corresponding sub input source of NET/USB is automatically played.

Lights up

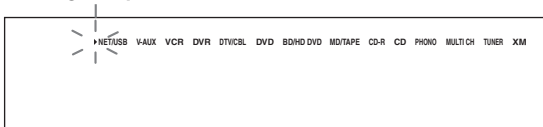

2 Press **②DISPLAY** to display the top NET/USB menu.

The following display appears on the video monitor. If any other screen appears on the video monitor, press **⑦MENU** on the remote control repeatedly until the top NET/USB menu appears.

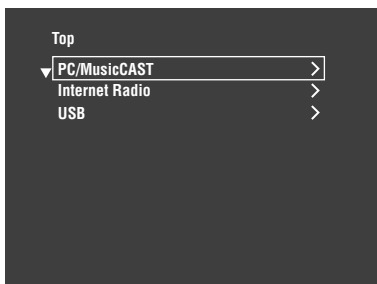

3 Press **④Δ / ▽** to select the desired sub input source and then press **④▷** or **④ENTER**.



You can also select the desired sub input source by pressing **⑦NET RADIO**, **⑦USB** or **⑦PC/MCX** when “NET/USB” is selected as the input source. This unit automatically starts playback of the last selected music file, Internet Radio station, or Podcast when you press **⑦NET RADIO**, **⑦USB** or **⑦PC/MCX**.

4 Press **④Δ / ▽ / ◀ / ▶** to select the desired song or Internet Radio station.

- Press **④Δ / ▽** to select the desired menu.
- Press **④▷** to enter the selected menu.
- Press **④◀** to return to the previous menu level.



- “>” in the right corner of each menu line indicates that there is a submenu available in the next menu level.
- You can also press **④ENTER** or **⑦MENU** to enter the selected menu or to return to the previous menu level.

5 Press **④ENTER** to play the selected song or to listen to the selected station.



- See page 63 for details about the functions of the play information display.
- Some items do not appear in the play information display depending on the selected sub input source.
- You can set the time for which the GUI screen of the network/USB is displayed on the video monitor by using the “On Screen” parameter in “Manual Setup” (see page 90).

Remote control operation

Before performing the following operations, set the operation mode selector on the remote control to **④SOURCE** and then press **①NET/USB**.

Button	Function
③ TITLE	Bookmark *1
④ Δ	Up
▽	Down
◀	Previous menu
▶	Subsequent menu
⑤ MEMORY	Memory
⑥ 1 - 8	Numeric buttons (1-8) *2
⑦ NET RADIO	Select “NET RADIO”
USB	Select “USB”
◀◀	Skip backward (“PC/MCX” and “USB” only)
▶▶	Skip forward (“PC/MCX” and “USB” only)
PC/MCX	Select “PC/MCX”
□	Stop
▷	Play
⑦ MENU	Previous menu
② DISPLAY	Display

*1 Press and hold to store your favorite Internet Radio stations with bookmarks (see page 67).

*2 Press to assign or recall the preset items (see page 68).

Using a PC server or Yamaha MCX-2000

Use this feature to enjoy music files saved on your PC or Yamaha MCX-2000. MCX-2000 is a music server that enhances the concept of Yamaha exclusive MusicCAST, a digital music delivery method over a personal network.

1 Install Windows Media Player 11 on your PC, or register this unit on your Yamaha MCX-2000.

- Refer to “Installing Windows Media Player 11 on your PC” and “Registering this unit on the Yamaha MCX-2000” on page 67.
- This procedure is needed only the first time.
- (PC only) You may need to make some setting of Windows Media Player 11 to start the contents sharing. Refer to the attached documents of Windows Media Player 11.

2 Turn on your PC or MCX-2000.

The PC server or MCX-2000 is added to the server list on the submenu of PC/MusicCAST.

3 Select a desired server or MusicCAST to begin playback.

Notes

- Yamaha MCX-2000 may not be for sale in some locations.
- You can connect this unit to up to 4 PC servers and 1 MCX-2000, and each server must be connected to the same subnet as this unit.
- Some WAV, MP3 and WMA files on your PC may not be playable or may be noisy when played.
- (MCX-2000 only) Files marked with an asterisk (*) have not been converted to MP3 format. You cannot play back such files immediately unless you set the “Receive PCM Stream” setting of this unit to “ON” on MCX-2000. For details, refer to the instruction manual of MCX-2000.



- While a song is being played, the time elapsed is displayed at the bottom of the playback information screen.
- You can use / to skip backward/forward and / to start/stop playback independently from the menu on the video monitor.
- You can set the settings for repeat and shuffle mode by using the “Play Style” parameters in “NET/USB” (see page 95).
- You can set the front panel display mode by using the “Scroll” parameter in “Front Panel Disp.” (see page 96).

■ Installing Windows Media Player 11 on your PC

With Windows Media Player 11, you can play back the audio files on your PC. For details refer to the documents of Windows Media Player 11.



You can also play back the audio files on your PC with Windows Media Connect 2.0 installed.

1 Install Windows Media Player 11 on your PC.

You can download the installer of Windows Media Player 11 from the Microsoft website, or use the upgrade function of the installed Microsoft Windows Media Player.

2 Turn on your PC and then share a folder on the PC.

The Shared folder is added to the server list on the submenu of PC/MusicCAST.

Notes

- If the operating system (OS) of your PC is Windows Vista, Windows Media Player 11 is pre-installed (except some products).
- Some security software installed on your PC (anti-virus software, firewall software, etc.) may block the access of this unit to your PC. In such cases, configure the security software appropriately.
- If you are using a PC with Windows XP Professional, and the PC is logging on to a domain, you may not be able to connect the PC server. In such cases, log on to the local machine instead of the domain.

■ Registering this unit on the Yamaha MCX-2000

You must register this unit on your Yamaha MCX-2000 so that this unit can be recognized by your Yamaha MCX-2000. For details, refer to the operation manual supplied with your Yamaha MCX-2000.

1 Turn off this unit.

2 Set your YAMAHA MCX-2000 to the “Auto Config” mode.

3 Turn on this unit.

- MCX-2000 is added to the server list on the submenu of PC/MCX.
- The client ID of this unit appears in the OSD of your Yamaha MCX-2000 (shown as CL-XXXXX), and this completes the automatic configuration procedure.

Notes

- The latter part of the client ID of this unit is same as the last 5 digits of the MAC address of this unit. For details about MAC address, see page 95.
- To clear the registered client ID of this unit, use the “Manual Config” mode of your Yamaha MCX-2000 (refer to the instruction manual of MCX-2000) and then set “INITIALIZE” in the advanced setup menu of this unit to “NETWORK” (see page 122).
- The client control functions of MusicCAST over this unit other than “View Play Info”, “Receive PCM Stream” and “Edit Client title” are not available. Avoid using these functions as it will stop the playback on this unit.

Using the Internet Radio

Use this feature to listen to Internet Radio stations. This unit uses the vTuner Internet Radio station database service particularly customized for this unit, providing over 2000 radio station database. Further, you can store your favorite stations with bookmarks.

Notes

- This service may be discontinued without notice.
- Some Internet Radio stations may not be played even if they are selected in the NET RADIO menu.
- To listen to the Internet Radio, connect this unit to your network (see page 31).
- A narrowband Internet connection (i.e. 56K modem, ISDN) will not provide satisfactory results, and a broadband connection is strongly recommended (i.e. a cable modem, an xDSL modem, etc.). For detailed information, consult with your ISP.



- You can use / to start/stop playback independently from the menu on the video monitor.
- “Podcast” is a type of the Internet Radio service, and there are a number of Podcast services available on the Internet. The Podcast is not a continuous service. That is, this unit stops playback when an episode of the Podcast ends.
- Some security devices (such as firewall) may block the access of this unit to Internet Radio stations. In such cases, configure the security settings appropriately.

■ Storing your favorite Internet Radio stations with bookmarks

Use this feature to select your favorite Internet Radio stations quickly.

Press and hold **TITLE** on the remote control while the selected Internet Radio station service is being broadcast.

The stored Internet Radio station is added to the “Bookmarks” list (see page 64).



- To remove the stored station from the list, select the item in the first level of the “Bookmarks” list and then press and hold **TITLE** on the remote control.
- You can also register your favorite Internet Radio stations to this unit by accessing the following website with the web browser on your PC. To use this feature, you need the MAC address of this unit as the ID number and your e-mail address to create your personal account. Use “Information” in the “NET/USB” menu to display the MAC address of this unit (see page 95). For details, refer to the help information on the website.
URL: <http://yradio.vtuner.com/>

4 Press desired numeric buttons (1-8) (ⓐ).

The number of the selected numeric button appears in the video monitor or front panel display.

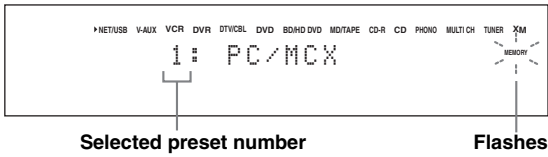

5 Press ④ENTER or ⑤MEMORY to confirm the preset.

■ Select an item by using numeric buttons (1-8) (ⓐ)

Before performing the following operations, set the operation mode selector on the remote control to ④SOURCE.

1 Press ①NET/USB to select "NET/USB" as the input source.

2 Select the desired sub input source.

3 Press one of the numeric button (1-8) (ⓐ) which the desired item is assigned to select the item as the input source.

The selected preset number appears in the front panel display, and this unit starts the playback of the source assigned to the selected numeric button.

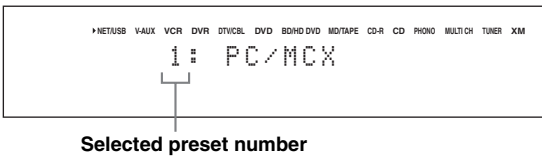

Notes

- "Empty Memory!" appears in the front panel display and the short message display when you press the numeric button (1-8) (ⓐ) to which no items are assigned.
- This unit does not recall the correct item assigned to the selected numeric button (1-8) (ⓐ) in the following cases:
 - the connected USB device is incorrect.
 - the PC or MCX-2000 which stores the selected item is turned off or disconnected from the network.
 - the selected Internet Radio station is temporary unavailable or out of service.
 - the directory of the selected item has been changed.



This unit stores the relative position of the preset items in a directory or playlist, and does not recall the correct item by using numeric buttons (1-8) (ⓐ) if you add or delete music files to or from the same directory or playlist as the preset items. In such cases, preset the desired item to the numeric buttons (1-8) (ⓐ) again.

We recommend the following methods:

PC server/MCX-2000

Create eight playlists which contain the desired items, and then preset the top item of each playlist to the numeric buttons (1-8) (ⓐ). When you change the items which are preset to the numeric buttons (1-8) (ⓐ), replace the registered items in the playlist with the desired items without deleting the playlist.

USB memory devices

Create eight directories which contain the desired items in a directory beside the directory which contains all music files, and then preset the top item of each directory to the numeric buttons (1-8) (ⓐ). When you change the items which are preset to the numeric buttons (1-8) (ⓐ), replace the items in the directory to the desired items without deleting the directory.

Recording

Recording adjustments and other operations are performed from the recording components. Refer to the operating instructions for those components.

Caution

The DTS signal is a digital bitstream. Attempting to digitally record the DTS bitstream will result in noise being recorded. Therefore, if you want to use this unit to record sources encoded in DTS, the following considerations and adjustments need to be made. To play DTS-encoded DVDs and CDs (when using a digital audio connection) on your DTS-compatible player, follow its operating instructions to make a setting so that the analog signal will be output from the player.

Notes

- When this unit is set to the standby mode, you cannot record between other components connected to this unit.
- TONE CONTROL (see page 51) and the volume settings, the speaker level (see page 94) and the sound field programs (see page 45) do not affect recorded material.
- The source connected to the MULTI CH INPUT jacks of this unit cannot be recorded.
- The XM Satellite Radio signals (U.S.A. and Canada models only) cannot be output at the audio OUT (REC) jacks.
- Digital signals input at the DIGITAL INPUT jacks are not output at the analog audio OUT (REC) jacks for recording. Likewise, analog signals input at the AUDIO IN jacks are not output at the DIGITAL OUTPUT jack. Therefore, if your source component is connected to provide only digital or analog signals, you can only record digital or analog signals.
- A given input source is not output on the same OUT (REC) channel.
- S-video and composite video signals pass independently through the video circuits of this unit. Therefore, when recording or dubbing video signals input from a video source component that provides only an S-video or a composite video signal, you can record only an S-video or a composite video signal on your VCR.
- The analog audio and video signals input at the DOCK terminal can be output at the analog audio OUT (REC) jacks and DVR or VCR OUT jacks for recording.
- Check the copyright laws in your country to record from CDs, radio, etc. Recording of copyrighted material may infringe copyright laws.



Do a test recording before you start an actual recording.

If you play back a video source that uses scrambled or encoded signals to prevent it from being dubbed, the picture itself may be disturbed due to those signals.

1 Turn on all the connected components.

2 Press  REC OUT/ZONE2 until the RECOUT indicator lights up in the front panel display.

This unit in the recording source selecting mode.



3 Rotate the  PROGRAM to select the source component you want to record from.

Carry out the operation while the RECOUT indicator is lit.



Select "SOURCE" to record the currently selected input source.

4 Start playback on the selected source component or select a broadcast station.

5 Start recording on the recording component.

Advanced sound configurations

Selecting decoders

Selecting decoders for 2-channel sources (surround decode mode)

Use this feature to play back sources with selected decoders. You can play back 2-channel sources on multi-channels.

Set the operation mode selector to **AMP** and then press **SUR. DECODE** repeatedly on the remote control to select the surround decode mode.

You can select desired surround decoder modes depending on the type of source you are playing and your personal preference.



You can select the desired decoder and adjust the decoder parameter settings by using GUI screen. See page 74 for details.

Decoder descriptions

Remote control button	Category and name of the program	Name of the decoder (Decoder Type)	Program description	
SUR.DECODE +10	SUR. DECODE Surround Decode	PLIIx Music PLII Music	Dolby Pro Logic Ix (or Dolby Pro Logic II) processing for music sources. The Pro Logic Ix decoder is not available when "Surround Back" is set to "None" (see page 92).	
	Panorama	Dimension	Center Width	EXTD Surround

Available decoder parameters (see page 80)

SUR.DECODE +10	SUR. DECODE Surround Decoder	PRO LOGIC	Dolby Pro Logic processing for any sources.	
			EXTD Surround	
SUR.DECODE +10	SUR. DECODE Surround Decoder	PLIIx Movie PLII Movie	Dolby Pro Logic Ix (or Dolby Pro Logic II) processing for movie sources. The Pro Logic Ix decoder is not available when "Surround Back" is set to "None" (see page 92).	
			EXTD Surround	
SUR.DECODE +10	SUR. DECODE Surround Decoder	PLIIx Music PLII Music	Dolby Pro Logic Ix (or Dolby Pro Logic II) processing for music sources. The Pro Logic Ix decoder is not available when "Surround Back" is set to "None" (see page 92).	
	Panorama	Dimension	Center Width	EXTD Surround
SUR.DECODE +10	SUR. DECODE Surround Decoder	PLIIx Game PLII Game	Dolby Pro Logic Ix (or Dolby Pro Logic II) processing for game sources. The Pro Logic Ix decoder is not available when "Surround Back" is set to "None" (see page 92).	
			EXTD Surround	

SUR.DECODE +10	SUR. DECODE Surround Decoder	Neo:6 Cinema	/	/
DTS processing for movie sources.				
EXTD Surround				
SUR.DECODE +10	SUR. DECODE Surround Decoder	Neo:6 Music	/	/
DTS processing for music sources.				
Center Image		EXTD Surround		
SUR.DECODE +10	SUR. DECODE Surround Decoder	Neural THX (U.S.A. and Canada models only)	/	/
Neural-THX Surround processing for any sources. The Neural-THX Surround decoder is especially suitable for the XM HD Surround program of XM Satellite Radio.				
EXTD Surround				



When you select the surround decode mode for the multi-channel digital sources, this unit automatically selects the corresponding decoder for each source.

■ Selecting decoders used with sound field programs

Use this feature to select the desired decoder used with MOVIE sound field programs (except “Mono Movie”). Use the “Decoder Type” parameter in “Stereo/Surround” to set the desired decoder (see page 76).



See page 48 for details about MOVIE sound field program.

Available decoders (Decoder Type)

Decoder	Functions
PLIIx Movie PLII Movie	Dolby Pro Logic IIX (or Dolby Pro Logic II) processing for movie sources. The Pro Logic IIX decoder is not available when “Surround Back” is set to “None” (see page 92).
Neo:6 Cinema	DTS processing for movie sources

Graphical user interface (GUI) screen

This unit features a sophisticated graphical user interface (GUI) screen that helps you to control the amplifier function of this unit. With the GUI screen, you can view the information of the signals being input and the status of this unit.

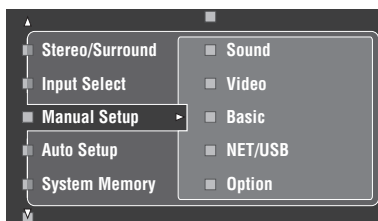

■ Stereo/Surround (Stereo/Surround menu)

Use this feature to select the sound field programs and customize the program parameter settings (see page 74).

■ Input Select (Input select menu)

Use this feature to select the input source and customize the parameters of each input source (see page 81).

■ Manual Setup (Manual setup menu)

Use this feature to manually adjust speaker and system parameters.

Volume (Volume menu)

See page 84 for details.

Sound (Sound menu)

See page 85 for details.

Video (Video menu)

See page 89 for details.

Basic (Basic menu)

See page 91 for details.

NET/USB (Network and USB menu)

See page 94 for details.

Option (Option menu)

See page 96 for details.

■ Auto Setup (Automatic setup menu)

Use this feature to run the automatic setup and specify which speaker parameters to be adjusted (see page 37).

■ System Memory (System memory menu)

Use this feature to store and recall various settings of this unit (see page 100).

■ Signal Info. (Signal information)

Use this feature to check audio signal information (see page 98).

■ Language (GUI language menu)

Use this feature to select the language of your choice that appears in the GUI screen of this unit (see page 99).



- You can also select the GUI language using “GUI Language” parameter in “Advanced setup” in the front panel display (see page 126).
- See page 44 for details about the operations in GUI screen.

Stereo/Surround (Stereo/Surround menu)

Use this feature to select the sound field programs (see page 45), the surround decode mode or the “STRAIGHT” mode (see page 50), and adjust the parameters of each program.

■ Selecting sound field programs and setting the parameters by using GUI screen

- 1 Set the operation mode selector to **⑭ AMP** and then press **⑰ SET MENU**.
- 2 Press **④ Δ / ▽ / ◀ / ▶** repeatedly to select “Stereo/Surround” and then press **④ ▶**.
- 3 Press **④ Δ / ▽** repeatedly to select the desired category of the programs and then press **④ ▶**.
- 4 Press **④ Δ / ▽** repeatedly to select the desired programs.
- 5 Press **④ ▶** on the remote control and then **④ Δ / ▽** to select the desired parameter.

 You can select “Initialize” to set all the parameters of the selected sound field program to the default values. See page 80 for details.
- 6 Press **④ ▶** and then press **④ ◀ / ▶** to adjust the selected parameter.
- 7 Press **④ ENTER** or **④ Δ / ▽** to confirm the setting of the selected parameter.

■ Basic configuration of sound field programs

Each sound field program has some parameters defining the characteristics of the program. To customize the selected sound field program, adjust “DSP Level” and/or “Dialogue Lift” first, and then try other parameters.

Adjusting the effect sound level of the sound field programs (DSP Level)

Sound field programs add effect sounds (DSP effect sounds) to the original source sound to create sound field in the listening room. Use the “DSP Level” parameter to adjust the level of the effect sounds.

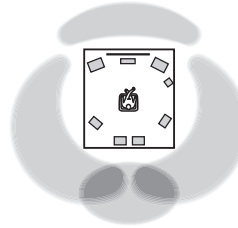

The DSP effect sound level is low.

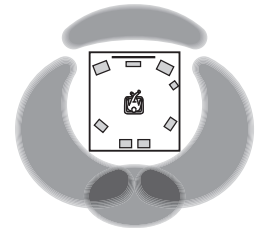

The DSP effect sound level is high.

Adjust “DSP Level” as follows:

Increase the value of “DSP Level” when

- the effect sound of the selected sound field program is too weak.
- you cannot recognize any difference between the sound field programs.

Decrease the value of “DSP Level” when

- the sound is vague.
- you feel that the additional sound effect is excessive.

Control range: -6 dB to +3 dB

Adjusting the vertical dialogue position (Dialogue Lift)

Use this feature to adjust the vertical position of the dialogues in movies. The ideal position of the dialogues is at the center of the video monitor screen.

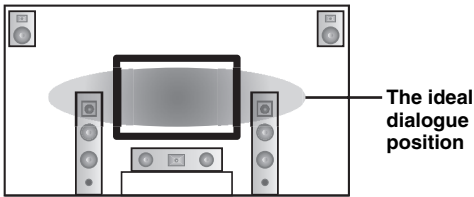

If the dialogues are heard at the lower position of the video monitor screen, increase the value of "Dialogue Lift".

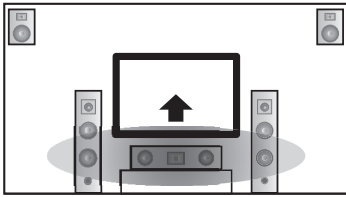

Move up to the ideal dialogue position.

Choices: **0**, 1, 2, 3, 4, 5

"0" (initial setting) is the lowest position, and "5" is the highest position.

Notes

- "Dialogue Lift" is available only when "Presence" is set to "Yes" (see page 92).
- You cannot move the dialogue position down from the initial dialogue position.

■ Sound field parameter descriptions

You can adjust the values of certain digital sound field parameters so that the sound fields are recreated accurately in your listening room. Not all of the following parameters are found in every program.

Sound field parameter	Features
Decoder Type	Decoder type. Selects the decoder used with the SUR, DECODE or MOVIE programs. See pages 71 and 72 for details.
Init. Delay Sur. Init. Delay SB. Init. Delay	<p>Initial delay. Presence, surround, and surround back sound field initial delay. Changes the apparent size of the sound field by adjusting the delay between the direct sound and the first reflection heard by the listener. The smaller the value, the smaller the sound field seems to the listener.</p> <p>🔊</p> <p>When you adjust the initial delay parameters, we also recommend that you adjust the corresponding room size parameters likewise. This adjustment is especially effective for the CINEMA DSP programs.</p> <p>Control range: 1 to 99 ms (Init. Delay) 1 to 49 ms (Sur. Init. Delay and SB Init. Delay)</p>

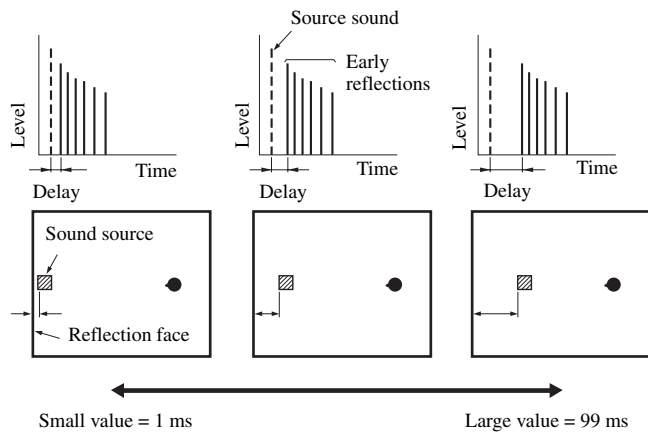

Room Size Sur. Room Size SB. Room Size	<p>Room size. Presence, surround, and surround back room size. Adjusts the apparent size of the sound field. The larger the value, the larger the surround sound field becomes. As the sound is repeatedly reflected around a room, the larger the hall is, the longer the time between the original reflected sound and the subsequent reflections. By controlling the time between the reflected sounds, you can change the apparent size of the virtual venue. Changing this parameter from one to two doubles the apparent length of the room.</p> <p>🔊</p> <p>When you adjust the room size parameters, we also recommend that you adjust the corresponding initial delay parameters likewise. This adjustment is especially effective for the CINEMA DSP programs.</p> <p>Control range: 0.1 to 2.0</p>
---	---

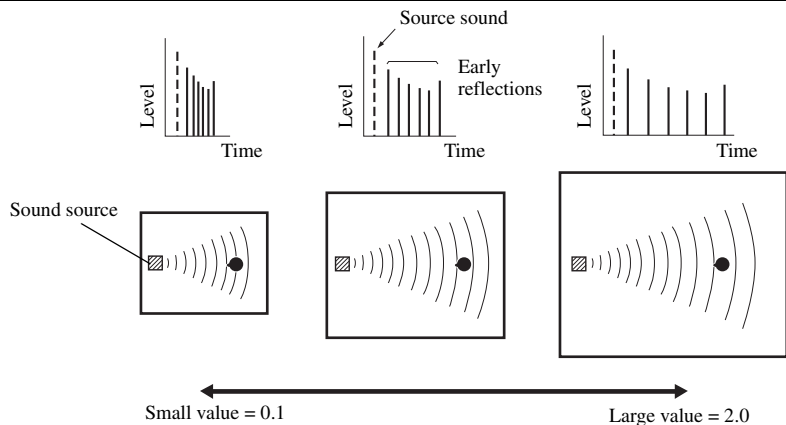

Sound field parameter	Features
-----------------------	----------

Liveness
Sur. Liveness
SB. Liveness

Liveness. Surround and surround back liveness. Adjusts the reflectivity of the virtual walls in the hall by changing the rate at which the early reflections decay. The early reflections of a sound source decay much faster in a room with acoustically absorbent wall surfaces than in one which has highly reflective surfaces. A room with acoustically absorbent surfaces is referred to as “dead”, while a room with highly reflective surfaces is referred to as “live”. This parameter lets you adjust the early reflection decay rate and thus the “liveness” of the room.

Control range: 0 to 10

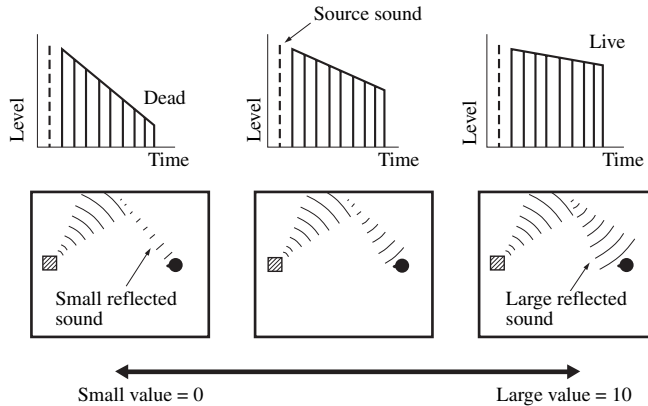

Rev. Time

Reverberation time. Adjusts the amount of time taken for the dense, subsequent reverberation sound to decay by 60 dB at 1 kHz. This changes the apparent size of the acoustic environment over an extremely wide range. Set a longer reverberation time to get more sustaining reverberation sound, and set a shorter time to get articulate sound.

Control range: 1.0 to 5.0 s

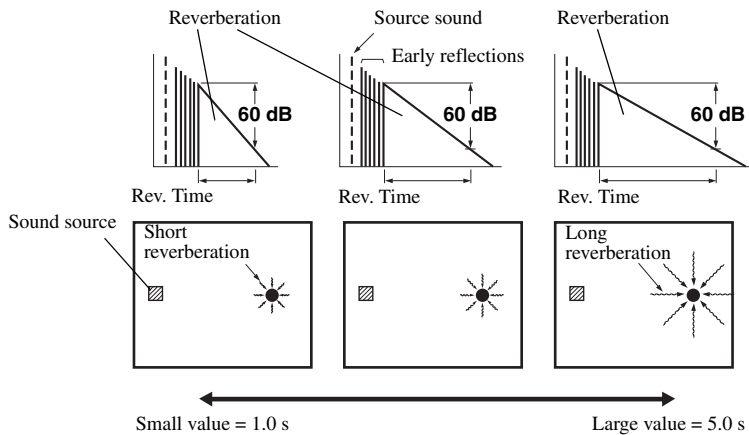

Sound field parameter	Features
-----------------------	----------

Rev. Delay

Reverberation delay. Adjusts the time difference between the beginning of the direct sound and the beginning of the reverberation sound. The larger the value, the later the reverberation sound begins. A later reverberation sound makes you feel as if you are in a larger acoustic environment.

Control range: 0 to 250 ms

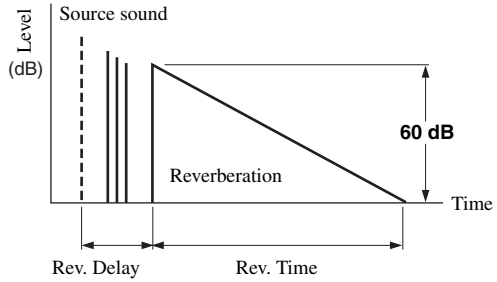

Rev. Level

Reverberation level. Adjusts the volume of the reverberation sound. The larger the value, the stronger the reverberation becomes.

Control range: 0 to 100%

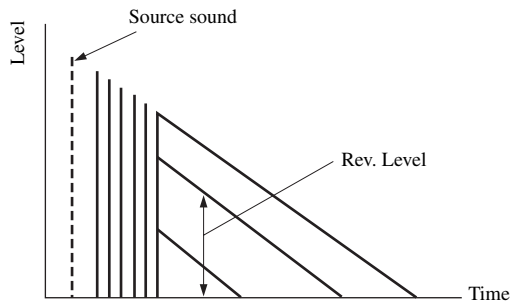

■ Stereo program parameter descriptions

Sound field parameter	Features
Direct (“2ch Stereo” only)	<p>2-channel stereo direct. Bypasses the decoders and DSP processors of this unit for pure hi-fi stereo sound when playing 2-channel analog sources.</p> <hr/> <p>Choices: Auto, Off</p> <hr/> <p>☼</p> <ul style="list-style-type: none"> • Select “Auto” to bypass the decoders, DSP processors and the tone control circuitry only when “BASS” and “TREBLE” are set to 0 dB (see page 51). • Select “Off” not to bypass the decoders, DSP processors and the tone control circuitry when “BASS” and “TREBLE” are set to 0 dB. • When multi-channel signals are input, they are downmixed to 2 channels and output from the front left and right speakers. • The low-frequency signals of the front left and right channels are redirected to the subwoofer in the following cases: <ul style="list-style-type: none"> – “Bass Out” is set to “Both” (see page 92). – “Front” is set to “Small” (see page 92) and “Bass Out” is set to “SWFR” (see page 92).
Center Level Surround L Level Surround R Level Sur. Back Level Presence L Level Presence R Level (“7ch Stereo” only)	<p>7-channel stereo center, surround left, surround right, surround back, presence left and presence right levels. Adjusts the volume level of each channel in the 7-channel stereo mode. The available parameters differ depending on the speaker settings.</p> <hr/> <p>Control range: 0 to 100%</p>

■ Compressed Music Enhancer mode parameter descriptions

The Compressed Music Enhancer mode	Features
Level (“Straight Enhancer” and “7ch Enhancer” only)	<p>Straight enhancer or 7-channel enhancer effect level. Select “High” or “Low” to adjust the effect for the high-frequency.</p> <hr/> <p>Choices: High, Low</p>

Decoder parameter descriptions

Decoder parameter	Features
Panorama ("PLIIX Music" and "PLII Music" only)	Pro Logic IIX Music and Pro Logic II Music panorama. Sends stereo signals to the surround speakers as well as the front speakers for a wraparound effect. Choices: Off , On
Center Width ("PLIIX Music" and "PLII Music" only)	Pro Logic IIX Music and Pro Logic II Music center width. Moves the center channel output completely towards the center speaker or towards the front left and right speakers. A larger value moves the center channel output towards the front left and right speakers. Control range: 0 (center channel sound is output only from the center speaker) to 7 (center channel sound is output only from the front left and right speakers) Initial setting: 3
Dimension ("PLIIX Music" and "PLII Music" only)	Pro Logic IIX Music and Pro Logic II Music dimension. Adjusts the sound field either towards the front or towards the rear. Control range: -3 (towards the rear) to +3 (towards the front) Initial setting: STD (standard)
Center Image ("Neo:6 Music" only)	DTS Neo:6 Music center image. Adjusts the front left and right channel output relative to the center channel to make the center channel more or less dominant as necessary. Control range: 0.0 (center channel sound is output only from the front left and right speakers) to 1.0 (center channel sound output only from the center speaker) Initial setting: 0.3
EXTD Surround (U.S.A. and Canada models only)	Extended surround mode. Selects the extended surround mode used for the multi-channel sources when the decoder is selected. See page 88 for details. Choices: AUTO , PLIIX Movie, PLIIX Music, EX/ES, EX, Neural-THX, OFF ☀️ You can select "Neural-THX" in "EXTD Surround". When you select "Neural-THX" in "EXTD Surround", this unit plays back Dolby Digital or DTS signals in 6.1/7.1 channels using the Neural-THX Surround decoder.

Initialize (Program parameters initialization)

Use this feature to initialize the parameter of the selected sound field program.

Choices: **No**, Yes

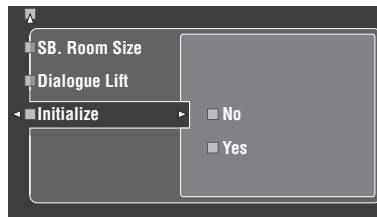

- Select "Yes" and then press **4** **ENTER** to set the program parameters to the factory default settings.
- Select "No" (or press **4** **◀**) to cancel the program parameter initialization.



Use "DSP PARAM" of "INITIALIZE" in "ADVANCED SETUP" to initialize the parameters of all sound field programs (see page 126).

Input Select

Use this feature to reassign digital input/outputs, select the input signal, rename the inputs, or adjust the level of the signal input at each input source.

Input source	Parameter
XM (U.S.A. and Canada models only)	Antenna Level Volume Trim Rename
TUNER	Volume Trim Rename
MULTI CH	Volume Trim Rename Multi CH Assign BGV
PHONO	I/O Assignment
CD	Audio Select
CD-R	Decoder Mode
MD/TAPE	Volume Trim
BD/HD DVD	Rename
DVD	
DTV/CBL	
DVR	
VCR	
V-AUX or DOCK	I/O Assignment* Audio Select* Decoder Mode* Volume Trim Rename
PC/MCX, NET RADIO or USB	Volume Trim

Notes

- Some parameters described above may not be available for all input sources and some parameters are only available for specific input sources.
- When iPod is stationed in a Yamaha iPod universal dock (such as YDS-10, sold separately) connected to the DOCK terminal of this unit, "DOCK" appears in the "Input Select" menu instead of "V-AUX". In such cases, the parameters marked with asterisk (*) in the above table do not appear in the input source parameter menu.
- When you select "NET/USB" as the input source, selected sub input source (PC/MCX, NET RADIO or USB) appears in the Input Select menu. You can set "Volume Trim" for each sub input source separately.

- Set the operation mode selector to **AMP** and then press **SET MENU**.

The top display appears.

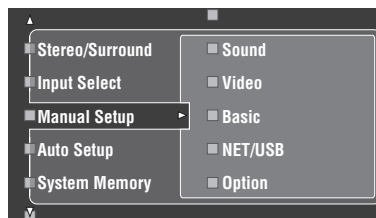

- Press **▲ / ▼** to select "Input Select" and then press **▶**.

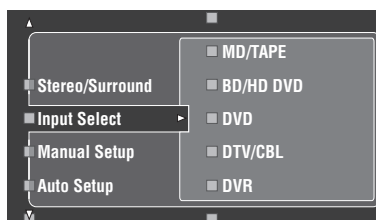

- Select the desired input source (CD, DVD, etc.) and then press **▶** or **ENTER** to access and adjust.

Antenna Level (Antenna level) (U.S.A. and Canada models only)

Use this feature to check the current reception level of the XM Satellite Radio signals (see page 56). For the best reception, adjust the orientation of the antenna of connected Home Dock so that a value of 60% or more is displayed here.

Display status: None, 0 to 100%

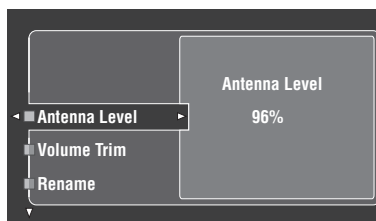

Notes

- "None" is displayed if the Home Dock is not connected to this unit. In this case, check the antenna connections (see page 56).
- The "Antenna Level" parameter cannot be adjusted by using the remote control. Instead, you need to adjust the orientation of the antenna of Home Dock connected to the XM jack of this unit for a better percentage of the reception level.

■ I/O Assignment (Input/output assignment)

Use this feature to assign the input/output jacks according to the component to be used if the initial settings of this unit do not correspond to your needs. Change the following parameters to reassign the respective jacks and effectively connect more components.

Once the input/output jacks are reassigned, you can select the corresponding component by using the **ⓈINPUT** selector (or the input selector buttons (①)).

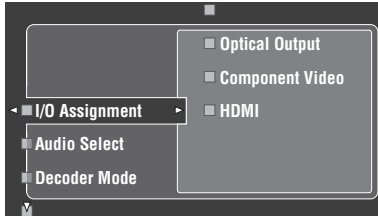

Example 1: Assigning the CD DIGITAL INPUT COAXIAL jack to the DVD input.

- 1 Select "Input Select" in the GUI screen and then select "DVD".
- 2 Select "I/O Assignment" and then "Coaxial Input".
- 3 Select "①CD".

Example 2: Clearing a jack assignment.

- 1 Select "Input Select" and then select the desired input source ("DVD", etc.).
- 2 Select "I/O Assignment" and then select the desired jack assignment ("Coaxial Input", "Optical Input", "Optical Output", "Component Video", or "HDMI").
- 3 Select "None" and then press **④ENTER** to clear the assignment.

Notes

- "None" appears in the GUI when any input source is not assigned to the input/output jack.
- You cannot select a specific item more than once for the same type of jack.
- When you connect a component to both the COAXIAL and OPTICAL jacks, priority is given to signals input at the COAXIAL jack.

■ Audio Select (Audio input jack select)

Use this feature to select the type of the input jack you want to use.

Choice	Functions
Auto	Automatically selects input signals in the following order: (1) HDMI (2) Digital signals (3) Analog signals
HDMI	Selects only HDMI signals. When HDMI signals are not input, no sound is output.
Coax/Opt	Automatically selects input signals in the following order: (1) Digital signals input at the COAXIAL jack. (2) Digital signals input at the OPTICAL jack. When no signals are input, no sound is output.
Analog	Selects only analog signals. If no analog signals are input, no sound is output.



- You can also select the audio input jack by pressing **ⓈAUDIO SELECT** on the front panel (or **ⓈAUDIO SEL** on the remote control). See page 42 for details.
- You can set the default audio input jack select of this unit by using "Audio Select" in "Option" (see page 98).

Note

This feature is not available when no digital input jack (OPTICAL, COAXIAL and HDMI) are assigned. In addition, "HDMI" is not available as an Audio input jack select setting when the HDMI input jacks are not used. Use "I/O Assignment" in "Input Select" to reassign the respective input jack.

■ Decoder Mode (Decoder mode)

Use this feature to switch the decoder mode. You can designate the reassigned digital input jacks (see page 82) for DTS signals.

Choice	Functions
Auto	Automatically detects digital audio signal input types and selects the appropriate decoder.
DTS	Activates the DTS decoder when digital audio signals are input.

■ Volume Trim (Volume trimming)

Use this feature to adjust the level of the signal input at each input source. This is useful if you want to balance the level of each input source to avoid sudden changes in volume when switching between input sources.

Control range: -6.0 dB to +6.0 dB

Initial setting: 0.0 dB



This parameter also affects the signals output at ZONE OUT jacks.

Note

You can only adjust the volume for the current input source using this setting.

■ Rename (Rename)

Use this feature to change the name of the inputs in the GUI screen or the front panel display menu. (DVD is used as the source component in the following example.)

- 1 Press **④** < / > to place the **_** (underscore) under the space or character you want to edit.

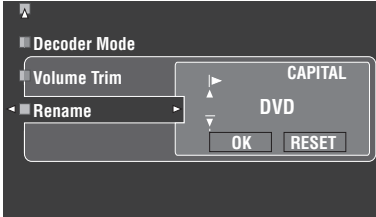

- 2 Press **④** **ENTER** repeatedly to select a character type (CAPITAL/SMALL/FIGURE/MARK).

- 3 Press **④** Δ / ∇ to select the character you want to use and **④** < / > to move to the next one.

- You can use up to 9 characters for each input.
- Press **④** ∇ to change the character in the following order, or press **④** Δ to go in the reverse order:
 CAPITAL A to Z, space
 SMALL a to z, space
 FIGURE 0 to 9, space
 MARK !, #, %, &, etc.
- Press **④** **ENTER** to switch between character types.
- Repeat steps 1 to 3 to rename each input.

Note

Even if you select “Français”, “Deutsch”, “Español” or “Русский” in “Language” (see page 99), you cannot use accent symbols or cyrillic alphabets for the name of each input.

- 4 Press **④** < / > repeatedly to select “OK” and press **④** **ENTER** when complete.



You can also change the name of the input source that appears in the display window (12) on the remote control. Refer to “Changing source names in the display window” on page 110.

Note

You can only change the name of the current input source (except for multi channel input sources) using this setting.

■ Multi CH Assign (Multi channel assignment)

Use this feature to set the direction of the signals input into the center, subwoofer and surround channels when a source component is connected to the MULTI CH INPUT jacks.

Input Channels (Input channels)

Use this setting to select the number of channels input from an external decoder (see page 29).

Choice	Description
6ch	Select “6ch” the connected component outputs discrete 6-channel audio signals.
8ch	Select “8ch” the connected component outputs discrete 8-channel audio signals. Also set “Front Input” (see below) to the analog audio jacks at which the front left and right channel signals output from the connected component are input.

Note

If “Zone2 Amplifier” (page 97) is set to “INT:[SP1]”, “INT:[SP2]” or “INT:Both”, no sound is output from the surround back speakers even if you select “8ch”. In this case, select “6ch” and set the output setting of the external component to 6 channels.

Front Input

(Front left and right channels input jacks)

If you selected “8ch” in “Input Channels”, you can select analog jacks at which front left and right channel signals from an external decoder will be input.

Choices: CD, CD-R, MD/TAPE, BD/HD DVD, **DVD**, DTV/CBL, DVR, VCR, V-AUX

■ BGV (Back ground video)

Use this feature to select the video source played in the background of the sources input at the MULTI CH INPUT jacks.

Choice	Functions
Last	Automatically selects the last selected video source as the background video source.
BD/HD DVD, DTV/CBL, DVD, DVR, VCR, V-AUX	Selects the corresponding input source as the background video source.
Off	Does not play the video source in the background.

Manual Setup (Volume)

Use this menu to manually adjust the various volume settings.

- 1 Set the operation mode selector to **AMP** and then press **SET MENU** on the remote control.
- 2 Press **△ / ▽** on the remote control to select “Manual Setup” and then press **▶**.
- 3 Press **△ / ▽ / ◀ / ▶** on the remote control to select “Volume” and then press **▶**.

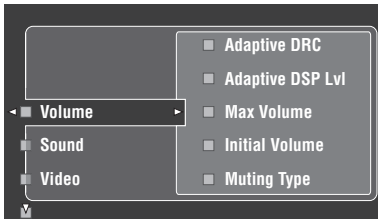

- 4 Select the desired parameters and then press **▶** to access and adjust.

Adaptive DRC (Adaptive dynamic range control)

Use this feature to adjust the dynamic range in conjunction with the volume level. This feature is useful when you are listening at lower volumes or at night. When “Adaptive DRC” is set to “Auto”, this unit controls the dynamic range as follows:

- If the VOLUME setting is low: the dynamic range is narrow
- If the VOLUME setting is high: the dynamic range is wide

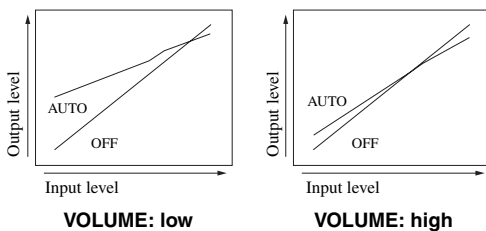

Choice	Functions
Auto	Adjusts the dynamic range automatically.
Off	Does not adjust the dynamic range automatically.



- You can also adjust the dynamic range of the bitstream signal sources by using “Dynamic Range” in “Sound” (see page 85).
- This function is also useful for listening with your headphones.

Note

The adaptive dynamic range control feature does not function when this unit is in the Pure Direct mode (see page 51).

Adaptive DSP Lvl (Adaptive DSP effect level)

Use this feature to make fine adjustments of the DSP effect level (see page 74) automatically in conjunction with the volume level.

Choice	Functions
Auto	Adjusts the DSP effect level in conjunction with the volume level.
Off	Does not adjust the DSP effect level automatically.

Note

Even if you set “Adaptive DSP Lvl” to “Auto”, this unit does not change but fine-tunes the specified value of “DSP Level” (see page 74).

Max Volume (Maximum volume)

Use this feature to set the maximum volume level in the main zone. This feature is useful to avoid the unexpected loud sound by mistake. For example, the original volume range is -80.0 dB to $+16.5$ dB. However, when “Max Volume” is set to -5.0 dB, the volume range becomes -80.0 dB to -5.0 dB. Control range: -30.0 dB to $+15.0$ dB, **+16.5 dB**
Control step: 5.0 dB

Initial Volume (Initial volume)

Use this feature to set the volume level of the main zone when the power of this unit is turned on. Choices: **Off**, Mute, -80.0 dB to $+16.5$ dB
Control step: 0.5 dB

Notes

- When this unit is in the auto setup procedure, the volume level is automatically set to 0 dB regardless of the current “Max Volume” setting.
- The “Max Volume” setting takes priority over the initial volume setting. For example, if “Initial Volume” is set to -20.0 dB and “Max Volume” is set to -30.0 dB, the volume level is automatically set to -30.0 dB when you turn on the power of this unit next time.

Muting Type (Muting type)

Use this feature to adjust how much the mute function reduces the output volume (see page 43).

Choice	Functions
Full	Mutes all the audio output.
-20 dB	Reduces the current volume by 20 dB.

Manual Setup (Sound)

Use this menu to adjust the sound parameters.

- 1 Set the operation mode selector to **AMP** and then press **SET MENU** on the remote control.
- 2 Press **△ / ▽** on the remote control to select “Manual Setup” and then press **▶**.
- 3 Press **△ / ▽ / ◀ / ▶** on the remote control to select “Sound” and then press **▶**.
- 4 Select the desired parameters and then press **▶** to access and adjust.

■ LFE Level (Low-frequency effect level)

Use this feature to adjust the output level of the LFE (low-frequency effect) channel according to the capacity of your subwoofer or headphones. The LFE channel carries low-frequency special effects which are only added to certain scenes. This setting is effective only when this unit decodes bitstream signals.

Control range: -20.0 to **0.0** dB

Control step: 1.0 dB

Speakers (Speaker low-frequency effect level)

Select to adjust the speaker LFE level.

Headphones

(Headphone low-frequency effect level)

Select to adjust the headphone LFE level.

Note

Depending on the settings of “Bass Out” (see page 92), some signals may not be output at the SUBWOOFER PRE OUT jack.

■ Dynamic Range (Dynamic range)

Use this feature to select the amount of dynamic range compression to be applied to your speakers or headphones. This setting is effective only when the unit is decoding bitstream signals.

Speakers (Speaker dynamic range)

Adjusts the dynamic range compression for the speakers.

Headphones (Headphone dynamic range)

Adjusts the dynamic range compression for the headphones.

Choice	Functions
MAX	Preserves the greatest amount of dynamic range.
STD	Adjusts the dynamic range to medium. When this unit is decoding Dolby TrueHD signals, the dynamic range control is always active regardless of the instruction of the input source signals.
MIN/AUTO	<ul style="list-style-type: none"> • MIN: Adjusts the dynamic range to narrow when this unit is decoding bitstream signals (except Dolby TrueHD). • AUTO: Adjusts the dynamic range according to the instruction of the input source signals when this unit is decoding Dolby TrueHD signals.

■ Parametric EQ (Parametric equalizer)

Use this feature to adjust the parametric equalizer of each speaker.

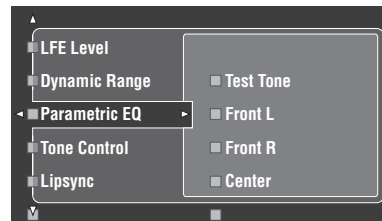

- 1 Press **△ / ▽ / ◀ / ▶** to select Test Tone or the speaker you want to adjust.

Choice	Adjusted speaker
Front L	Front left speaker
Front R	Front right speaker
Center	Center speaker
Surround L	Surround left speaker
Surround R	Surround right speaker
Surround Back L	Surround back left speaker
Surround Back R	Surround back right speaker
Presence L	Presence left speaker
Presence R	Presence right speaker
Subwoofer	Subwoofer

Test Tone

Use this feature to select whether to turn on or off the test tone output while you are adjusting the tonal quality of each speaker.

Choice	Functions
On	Outputs the test tone.
Off	Does not output the test tone.

2 Press **4** **▷** to access the settings window.

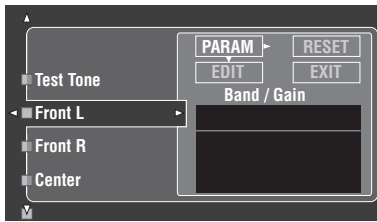

3 Press **4** **△** / **▽** / **◀** / **▶** to select “PARAM” and then press **4** **ENTER** to select a parameter from “Band” (band), “Freq.” (frequency) or “Q” (Q factor).



You can adjust “Gain” (gain) with any parameter.

4 Press **4** **▽** to select “EDIT” and press **4** **ENTER** to access the edit window.

For more information on the parametric equalizer and each parameter, see page 142.

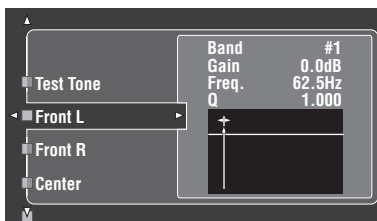

The parameter selected in “PARAM” is highlighted.

- Press **4** **◀** / **▶** to adjust the parameter.
- Press **4** **△** / **▽** to adjust the “Gain”.
- Press **4** **ENTER** to exit the edit window.



- When you select “Band” in step 3, you can use this menu as a graphic equalizer.
- The “Band #1” and “Band #2” can adjust the frequencies below of 198.4 Hz.
- When you select “Subwoofer” in step 1 and “Band” in step 3, you can adjust “Band #1” and “Band #2” only.

5 Repeat steps 3 and 4 until you are satisfied with the results.



If you want to reset all “Parametric EQ” parameter settings for the selected speaker, select “RESET” and press

4 **ENTER**.

6 Select “EXIT” and press **4** **ENTER** to exit the settings window.

■ Tone Control (Tone control)

Use this feature to adjust the balance of bass and treble output to your speakers or headphones.

Note

Tone Control is not effective when:

- PURE DIRECT (see page 51) is selected.
- MULTI CH INPUT is selected as the input source.

Control (Tone control)

Choice	Functions
Speaker	adjust the bass/treble balance of your speakers.
Headphone	adjust the bass/treble balance of your headphones.



“Speaker” and “Headphone” adjustments are stored independently. The adjustments for “Speaker” affects the front left/right, center, presence left/right speaker channels and Subwoofer channel.

Bass (Bass control)

Use this feature to adjust low-frequencies output to your speakers or headphones.

Choices: 125Hz, **350Hz**, 500Hz

Control range: – 6.0 dB to +6.0 dB

Initial setting: 0.0 dB

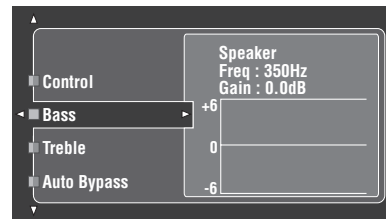

Treble (Treble control)

Use this feature to adjust high-frequencies output to your speakers or headphones.

Choices: 2.5kHz, **3.5kHz**, 8.0kHz

Control range: -6.0 dB to +6.0 dB

Initial setting: 0.0 dB

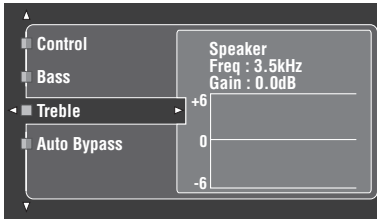
**Auto Bypass (Auto bypass)**

Use this feature to select whether the audio output bypasses the tone control circuitry when “Treble” and “Bass” are set to 0 dB (see page 51).

Choice	Functions
Auto	Automatically bypasses the tone control circuitry to provide the purest signal possible when “TREBLE” and “BASS” are set to 0 dB.
Off	Does not bypass the tone control circuitry.

■ Lipsync (Audio and video synchronization)

Use this feature to adjust the audio and video synchronization.

HDMI Auto (HDMI automatic lip sync mode)

If the connected video monitor is connected to the HDMI OUT jack of this unit and compatible with the automatic audio and video synchronization function (automatic lip sync), this unit adjusts the audio and video synchronization automatically. Use this feature to activate or deactivate the automatic lip sync.

Choice	Descriptions
Off	Select this setting if the connected video monitor is compatible with the automatic lip sync. Use “Auto” to make fine adjustments of the audio and video synchronization.
On	Select this setting if the video monitor is not compatible with the automatic lip sync or you do not want to use the automatic lip sync. Use “Manual” to adjustment the audio and video synchronization.

Auto (Automatic audio delay adjustment)

Use this feature to make fine adjustments of the audio and video synchronization when you set “HDMI Auto” to “ON”.

Control range: **0** to 240 ms

Control step: 1 ms



“offset” indicates the difference between the value of the audio delay that this unit sets automatically and the value of the audio delay that you set in “Auto”. This unit stores the value of “offset” and applies the value to other automatic lip sync compatible video monitors.

Manual (Manual audio delay adjustment)

Use this feature to adjust the delay of the sound output manually to synchronize audio with video images when you set “HDMI Auto” to “Off”.

Control range: **0** to 240 ms

Control step: 1 ms

■ EXTD Surround (Extended surround)

Use this feature to enjoy 6.1/7.1-channel playback for multi-channel sources using the Dolby Pro Logic IIx, Dolby Digital EX, or DTS-ES decoders by using the connected surround back speakers.

Choice	Functions
Auto	Activates the optimum decoder to play back signals in 6.1/7.1 channels when this unit recognizes a signal flag being input.
PLIIx Movie	Plays back multi-channel sources in 7.1 channels using the Pro Logic IIx movie decoder.
PLIIx Music	Plays back multi-channel sources in 6.1/7.1 channels using the Pro Logic IIx music decoder.
EX/ES	Plays back multi-channel sources in 6.1/7.1 channels using the Dolby Digital EX or DTS-ES decoder.
EX	Plays back multi-channel sources in 6.1/7.1 channels using the Dolby Digital EX decoder.
Off	Does not use any decoders to create 6.1/7.1 channels.



Use this feature to activate the desired decoder manually when this unit cannot detect the signal flag encoded to the input sources correctly.

Notes

- The available decoders vary depending on the setting of the speakers and the input sources.
- 6.1/7.1-channel playback is not possible in the following cases:
 - when “Surround” (see page 92) or “Surround Back” (see page 92) is set to “None”.
 - when the component connected to the MULTI CH INPUT jacks is being played.
 - when the source being played does not contain surround left and right channel signals.
 - when a Dolby Digital KARAOKE source is being played.
 - when this unit is in the stereo playback, Compressed Music Enhancer (see page 79) or Pure Direct (see page 51) mode.
 - when “BI-AMP” is set to “On” (see page 126).
- When this unit is turned off, this setting will be reset to “Auto”.
- (U.S.A. and Canada models only) “EXTD Surround” does not function when this unit is in the surround decode mode (see page 72). You can select the desired extended surround mode for each decoder by setting “EXTD” (see page 80).

■ Channel Mute (Channel mute)

Use this feature to mute specific speaker channels.

Mode (Mode)

Use this feature to activate or deactivate the “Channel Mute” setting for each speaker.

Choice	Functions
Disable	Deactivates the “Channel Mute” function.
Enable	Activates the “Channel Mute” function.

Each speaker settings

Select whether this unit mutes each speaker channel when you set “Mode” to “Enable”.

Channel Mute	Speaker channel
Front L	Front left
Front R	Front right
Center	Center
Surround L	Surround left
Surround R	Surround right
Surround Back L	Surround back left
Surround Back R	Surround back right
Presence L	Presence left
Presence R	Presence right
Subwoofer	Subwoofer

Choice	Functions
Mute On	Mutes the selected speaker channel.
Mute Off	Does not mute the selected speaker channel.

Manual Setup (Video)

Use this menu to adjust the video parameters.

- 1 Set the operation mode selector to **AMP** and then press **SET MENU** on the remote control.
- 2 Press **△ / ▽ / ◀ / ▶** on the remote control to select “Manual Setup” and then press **▶**.
- 3 Press **△ / ▽ / ◀ / ▶** on the remote control to select “Video” and then press **▶**.
- 4 Select the desired parameters and then press **▶** to access and adjust.

Note

Use the “Video” in “Initialize” to set the parameters in “Manual Setup (Video)” (except “Short Message” and “On Screen”) to the factory presets (see page 126).

■ Conversion (Video conversion)

Use this feature to activate or deactivate the video scaling as well as the HDMI up-conversion of the analog video signals input at the composite VIDEO, S VIDEO, and COMPONENT VIDEO jacks.

Choice	Functions
On	Converts composite, S-video, and component video signals interchangeably and up-converts composite, S-video, and component video signals to HDMI video signals.
Off	Does not convert any signals.

Notes

- This unit does not convert 480 line video signals and 576 line video signals interchangeably.
- The analog component video signals with 480i (NTSC)/576i (PAL) of resolution are converted into the S-video or composite video signals and output at the S VIDEO MONITOR OUT and VIDEO MONITOR OUT jacks.
- The converted video signals are only output at the MONITOR OUT jacks. When recording a video source, you must make the same type of video connections between each component.
- When composite video or S-video signals from a VCR are converted into component video signals, the picture quality may suffer depending on your VCR.
- Even when “Conversion” is set to “On”, HDMI digital signals are not converted to analog video signals.
- If “Conversion” is set to “Off”, the “Component I/P”, “HDMI Resolution”, “HDMI Aspect”, and “Short Message” features are deactivated.
- Set “Conversion” to “On” to display the short message.
- Unconventional signals input at the composite video or S-video jacks cannot be converted or may be output abnormally. In such cases, set “Conversion” to “Off”.
- When non-standard video signals (such as video signals from a video game console) are input, this unit does not display short messages on the video monitor even if “Conversion” is set to “On”.
- When the analog component video signals with 480p of resolution are input at the COMPONENT VIDEO jacks and the video monitor is connected to the VIDEO MONITOR OUT or S VIDEO MONITOR OUT jack of this unit, the GUI screen is not displayed on the video monitor.
- This unit does not up-scale the analog component video signals with 720p or 1080i of resolution.

■ Component I/P (Component interlace/progressive conversion)

Use this feature to activate or deactivate the analog interlace/progressive conversion of the analog video signals input at the composite video, S-video and component video jacks so that the analog video signals deinterlaced from 480i (NTSC)/576i (PAL) to 480p/576p are output at the COMPONENT MONITOR OUT jacks.

Choice	Functions
On	Activates the analog interlace/progressive up-conversion of the analog video signals.
Off	Deactivates the analog interlace/progressive up-conversion of the analog video signals.

Notes

- This menu item is not available and hence not visible in the GUI screen if “Conversion” is set to “Off”.
- If your video monitor does not support analog video signals with 480p/576p of resolution, the GUI screen may not be displayed on your video monitor when “Component I/P” is set to “On”. In such a case, set “VIDEO” of “INITIALIZE” in “ADVANCED SETUP” parameter to “Off” (see page 126).

■ HDMI Resolution (HDMI video signal resolution)

Use this feature to activate or deactivate the HDMI up-scaling of the analog video signals input at the composite video, S-video and component video jacks so that the up-scaled analog video signals are output at the HDMI OUT jack.

This unit up-scales the analog video signals as follows:

- 480i (NTSC)/576i (PAL) → 480p/576p, 1080i, 720p, or 1080p
- 480p/576p → 1080i, 720p, or 1080p

Choice	Functions
Through	Does not up-scale any analog video signals.
480p (or 576p), 1080i, 720p, 1080p	Up-scales analog video signals to 480p or 576p, 1080i, 720p, or 1080p of resolution.

Notes

- This menu item is not available and hence not visible in the GUI menu if “Conversion” is set to “Off” (see page 89).
- This unit does not up-scale the digital video signals input at the HDMI input jacks.

■ HDMI Aspect (HDMI aspect ratio)

Use this feature to select the adjustment of aspect ratio for analog video signals output at the HDMI OUT jack.

Choice	Functions
Through	Does not make any adjustments to the aspect ratio for the HDMI video signal sources.
16:9 Normal	Displays video images with the aspect ratio of 4:3 on your video monitor with the aspect ratio of 16:9. Black stripes appear on the right and left sides as a result.
Smart Zoom	Fits video images with the aspect ratio of 4:3 to your video monitor with the aspect ratio of 16:9.

Notes

- When “HDMI Resolution” is set to “Through”, you cannot make any adjustments to “HDMI Aspect”.
- If the aspect ratio of the input video source is other than 4:3, this unit automatically ignores the setting of “HDMI Aspect”.
- When “HDMI Aspect” is set to “Smart Zoom”, the video images of the edge of the video monitor are rather stretched.
- When the video signals are input at HDMI IN jacks or the signals are input with 720p, 1080i or 1080p of resolution, the setting of “HDMI Aspect” does not affect the video signals output at the HDMI OUT jack.

■ Short Message (Short message display)

Use this feature to activate or deactivate the short message display function.

Choice	Functions
On	Activates the short message display function. The contents of the front panel display appear at the bottom of the screen each time you operate this unit.
Off	Deactivates the short message display function.

Note

The short message display does not appear in the following cases:

- when the component video signals with 720p, 1080i or 1080p resolutions are input
- when HDMI video signals are input

■ On Screen (On-screen display time)

Use this feature to set the time for which the XM Satellite Radio information, iPod or NET/USB menu is displayed on the video monitor after you perform a certain operation.

Choice	Functions
Always	Displays the OSD unceasingly during an operation.
10sec	Turns off the OSD 10 seconds after you perform a certain operation.
30sec	Turns off the OSD 30 seconds after you perform a certain operation.

■ Position (GUI screen position)

Use this feature to adjust the vertical and horizontal position of the GUI screen.

Control range: -5 (downward/left) to +5 (upward/right)

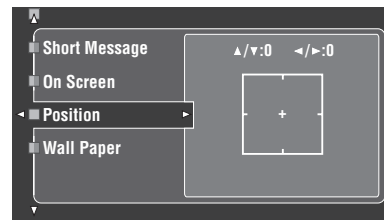

Button	Moving direction of the GUI display
④ Δ	Up
④ ∇	Down
④ ▷	Right
④ ◀	Left

■ Wall Paper (Wall paper)

Use this feature to display the wall paper or gray background in your video monitor when there is no video signal being input.

Choice	Functions
None	Does not display any background in your video monitor.
Yes	Display a background image (the photograph of a piano) in your monitor when there is no video signal being input.
Gray	Display a gray background in your monitor when there is no video signal being input.

Note

When “Conversion” is set to “Off”, no background is displayed even if “Wall Paper” is set to “Yes”.

Manual Setup (Basic)

Use this menu to manually adjust any speaker setting.

- 1 Set the operation mode selector to **⑭AMP** and then press **⑰SET MENU** on the remote control.**
- 2 Press **④△ / ▽** to select “Manual Setup” and then press **④▷**.**
- 3 Press **④△ / ▽ / ◀ / ▶** to select “Basic” and then press **④▷**.**
- 4 Select the desired parameters and then press **④▷** to access and adjust.**



- Most of the parameters described in the basic menu are set automatically when you run “Auto Setup”. You can use the basic menu to make further adjustments, but we recommend running “Auto Setup” first.
- You can reset these parameters by performing the “Auto Setup” procedure (see page 37).
- If your subwoofer can adjust the output volume and the crossover frequency, set the volume to about half way (or slightly less) and set the crossover frequency to the maximum.

■ Test Tone (Test tone)

Turns the test tone output on or off for “Speaker Set”, “Speaker Distance”, and “Speaker Level” settings.

Choice	Functions
Off	This unit does not output the test tone for the “Speaker Set”, “Speaker Level”, and “Speaker Distance” settings.
On	This unit outputs the test tone for the “Speaker Set”, “Speaker Level”, and “Speaker Distance” settings.



If you use a handheld sound pressure level meter, hold at arm’s length and point upwards so that the meter is in the listening position. With the meter set to the 70 dB scale and to C SLOW, calibrate each speaker to 75 dB.

Notes

- Loud test tones will be output when “On” is selected. In this case, make sure no children are present in the listening room.
- This function is automatically turned off if you exit “Basic”.

■ Speaker Set (Speaker settings)

Use to manually adjust any speaker setting.



If you are not satisfied with the bass sounds from your speakers, you can change these settings according to your preference.

Measure for the speaker size

The woofer section of a speaker is

- 16 cm (6.5 in) or larger: large
- smaller than 16 cm (6.5 in): small

Front (Front speakers)

Choice	Descriptions
Large	Select this setting when the front speakers are large.
Small	Select this setting when the front speakers are small.

Notes

- When “Bass Out” is set to “Front”, the LFE signals found in bitstream sources, the low-frequency signals of the front left and right channels, and the low-frequency signals of other speakers set to “Small” are all directed to the front left and right speakers regardless of the “Front” setting.
- When “Bass Out” is set to “Front”, you can select only “Large” in “Front”. If the value of “Front” is set to other than “Large” in advance, this unit change the value to “Large” automatically.

Center (Center speaker)

Choice	Descriptions
Large	Select this setting when the center speaker is large.
Small	Select this setting when the center speaker is small.
None	Select this setting when you do not use the center speaker. The center channel signals are directed to the front left and right speakers.

Surround (Surround left/right speakers)

Choice	Descriptions
Large	Select this setting when the surround speakers are large.
Small	Select this setting when the surround speakers are small.
None	Select this setting when you do not use the surround speakers. This unit is set to the Virtual CINEMA DSP mode (see page 50), and “Surround Back” is automatically set to “None”.



See page 15 for the connection information of the surround speakers.

Surround Back (Surround back left/right speakers)

Choice	Descriptions
Large x1	Select this setting when the single surround back speaker is large.
Large x2	Select this setting when the surround back left and right speakers are Large.
Small x1	Select this setting when the single surround back speaker is small.
Small x2	Select this setting when the surround back left and right speakers are small.
None	Select this setting when you do not use the surround back speakers. The surround back channel signals are directed to the surround left and right speakers.



See page 15 for the connection information of the surround speakers.

Presence (Presence speakers)

Use this feature if you want to use the presence speakers connected to this unit.

Choice	Descriptions
Yes	Select “Yes” when you use the presence speakers.
None	Select “None” when you do not use the presence speakers.

Notes

- If you set “Presence” to “No”, you cannot activate the CINEMA DSP 3D mode (see page 50).
- “Dialogue Lift” is available only when “Presence” is set to “Yes” (see page 75).

Bass Out (Bass out)

Use this feature to select the speakers that output the LFE (low-frequency effect) and the low-frequency signals.

LFE signals output

Choice	Subwoofer and speakers		
	Subwoofer	Front speakers	Other speakers
Both	Output	Output	No output
SWFR	Output	No output	No output
Front	No output	Output	No output

Low-frequency signals output

Choice	Subwoofer and speakers		
	Subwoofer	Front speakers	Other speakers
Both	*1	*2	*3
SWFR	*4	*3	*3
Front	No output	*1	*3

*1 Output(s) the low-frequency signals of the front channels and other speakers set to “Small” or “None”.

*2 Always output the low-frequency signals of the front channels.

*3 Output the low-frequency signals if the speakers are set to “Large”.

*4 Outputs the low-frequency signals of the speakers set to “Small” or “None”.

Bass Cross Over (Bass cross over)

Use this feature to select the crossover frequency of all the speakers set to “Small” or to “None” in “Speaker Set” (see pages 91 and 92). All frequencies below the selected frequency will be sent to the subwoofer or to the speakers set to “Large” in “Speaker Set” (see pages 91 and 92).

Choices: 40Hz, 60Hz, **80Hz**, 90Hz, 100Hz, 110Hz, 120Hz, 160Hz, 200Hz



If your subwoofer can adjust the output volume and the crossover frequency, set the volume to about half way (or slightly less) and set the crossover frequency to the maximum.

SWFR Phase (Subwoofer phase)

Use this feature to switch the phase of your subwoofer if bass sounds are lacking or unclear.

Choice	Functions
Normal (normal)	Does not change the phase of your subwoofer.
Reverse (reverse)	Sets the phase of your subwoofer to reverse.

PR/SB Priority

(Presence/surround back speaker priority)

Use this feature to prioritize either the presence or the surround back speakers when playing back 2-channel audio sources using the sound field programs.

Choice	Functions
Presence	Uses the presence speakers.
Surround Back	Uses the surround back speakers.

Note

When the CINEMA DSP 3D mode is active (see page 50), this unit always prioritize the presence speakers.

Speaker Distance (Speaker distance)

Use this feature to manually adjust the distance of each speaker and the delay applied to the respective channel. Ideally, each speaker should be the same distance from the main listening position. However, this is not possible in most home situations. Thus, a certain amount of delay must be applied to the sound from each speaker so that all sounds will arrive at the listening position at the same time.

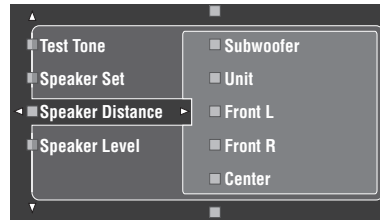

Speaker distances

Control range: 0.30 to 24.00 m (1.0 to 80.0 ft)

Initial setting:

Front L/Front R/Subwoofer/Presence L/Presence R/

Subwoofer: 3.00 m (10.0 ft)

CENTER: 2.60 m (8.5 ft)

Surround L/Surround R/Surround Back L/

Surround Back R: 2.40 m (8.0 ft)

Control step: 0.1 m (0.5 ft)

Speaker Distance	Adjusted speaker
Front L	Front left speaker
Front R	Front right speaker
Center	Center speaker
Surround L	Surround left speaker
Surround R	Surround right speaker
Surround Back L	Surround back left speaker
Surround Back R	Surround back right speaker
Presence L	Presence left speaker
Presence R	Presence right speaker
Subwoofer	Subwoofer



If your subwoofer can adjust the output volume and the crossover frequency, set the volume to about half way (or slightly less) and set the crossover frequency to the maximum.

Notes

- The available speaker channels differ depending on the setting of the speakers.
- If you are only using one surround back speaker, connect it to the SURROUND BACK SINGLE jack, and adjust the distance in “Surround Back L”.

Unit (Unit)

Selects the unit for displaying the values of “Speaker Distance” parameter.

Initial setting: Feet (U.S.A. and Canada models)
Meter (Other models)

Choice	Functions
Meter (m)	Adjusts speaker distances in meters.
Feet (ft)	Adjusts speaker distances in feet.

■ Speaker Level (Speaker level)

Use this feature to manually balance the speaker levels between the front left or surround left speakers and each speaker selected in “Speaker Set” (see page 91).

Control range: -10.0 dB to +10.0 dB

Initial setting:

Front L/Front R/Presence L/Presence R/Subwoofer:
0.0 dB

CENTER/Surround L/Surround R/Surround Back L/
Surround Back R: -1.0 dB

Control step: 0.5 dB

Speaker Level	Adjusted speaker
Front L	Front left speaker
Front R	Front right speaker
Center	Center speaker
Surround L	Surround left speaker
Surround R	Surround right speaker
Surround Back L	Surround back left speaker
Surround Back R	Surround back right speaker
Presence L	Presence left speaker
Presence R	Presence right speaker
Subwoofer	Subwoofer



If your subwoofer can adjust the output volume and the crossover frequency, set the volume to about half way (or slightly less) and set the crossover frequency to the maximum.

Notes

- The available speaker channels differ depending on the setting of the speakers.
- If you are only using one surround back speaker, connect it to the SURROUND BACK SINGLE jack, and adjust the balance in “Surround Back L”.

Manual Setup (NET/USB)

Use this menu to adjust the network and USB system parameters.

■ Network (Network settings)

Use this feature to view the network parameters (IP address, etc.) or to change them manually.

DHCP (DHCP setting)

Use this feature to select whether this unit can obtain the network parameters (IP address, subnet mask, default gateway, primary DNS server and secondary DNS server) from the DHCP server of the connected network.

Choice	Descriptions
On	Select this setting when this unit can obtain the network parameters from the DHCP server of the connected network.
Off	Select this setting when you set the network parameters manually.

IP Address (IP address)

Use this parameter to specify an IP address assigned to this unit. This value must not duplicate the one used for other devices in the target network.

Subnet Mask (Subnet mask)

Use this parameter to specify the subnet mask value assigned to this unit.



For most of the cases, the subnet mask value can be set as “255.255.255.0”.

Default Gateway (Default gateway)

Use this parameter to specify the IP address of the default gateway.

DNS Server (P) (Primary DNS server)

DNS Server (S) (Secondary DNS server)

Use this parameter to specify the IP address of the primary and secondary DNS (Domain Name System) servers.

Note

If you have only one DNS address, enter the DNS address in “DNS Server (P)”. If you have two or more DNS addresses, enter one of them in “DNS Server (P)” and another in “DNS Server (S)”.

Setup (Setup)

Select “Setup” to confirm the settings of the “Network” parameters.

Procedure of the network configuration

- 1 From the top GUI screen, press $\text{④}\Delta / \nabla$ on the remote control repeatedly and then $\text{④}\triangleright$ to select “Network”.
- 2 Press $\text{④}\Delta / \nabla$ repeatedly and then $\text{④}\triangleright$ to select “DHCP”.
- 3 Press $\text{④}\Delta / \nabla$ to select “On” or “Off” and then $\text{④}\text{ENTER}$ to confirm.
 - If you select “On”, you do not have to set other network parameters. Refer to step 5 and finish the configuration.
 - If you select “Off”, you need to set other network parameters. Refer to steps 4 through 6 to set the parameters.
- 4 Press $\text{④}\Delta / \nabla$ to select the desired parameter and then $\text{④}\triangleright$.
- 5 Press $\text{④}\triangleleft / \triangleright$ repeatedly to select the digit to change and then press $\text{④}\Delta / \nabla$ repeatedly to change the number.
- 6 Press $\text{④}\text{ENTER}$ to confirm the setting of the parameter.
- 7 Repeat steps 4 through 6 to configure each network parameter.
- 8 Press $\text{④}\nabla$ repeatedly to select “Setup” and then $\text{④}\text{ENTER}$ to finish configuration.

Note

In case you have changed your network configuration, you may need to reconfigure the network settings again.



You can reset the network settings of this unit to the initial factory settings by using “NETWORK” or “INITIALIZE” in the advanced setup menu (see page 126).

■ Play Style (Playback styles)

Use this feature to adjust the playback style according to your preference. You can shuffle songs in a random order or repeat one specific song or a sequence of songs.

Repeat (Repeat)

Use this feature to set this unit to repeat one song or a sequence of songs.

Choice	Functions
Off	Deactivates the repeat function.
Single	Repeats one song. “ $\text{④}\text{↺}$ ” appears in the top right corner of the playback status screen.
All	Repeats a sequence of songs. “ $\text{④}\text{↻}$ ” appears in the top right corner of the playback status screen.

Note

If “Repeat” is set to “Single”, the setting will be reset to “Off” when this unit is turned off.

Shuffle (Shuffle)

Use this feature to set this unit to play songs or albums in a random order.

Choice	Functions
Off	Deactivates the shuffle function.
On	Play songs or albums in a random order. “ $\text{④}\text{↻}$ ” appears in the top right corner of the playback status screen.

■ Information (Network information)

Use this feature to display the network system information.

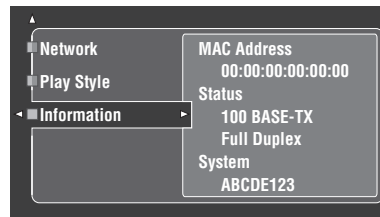

Note

The above display is an example.

MAC Address

(MAC (Media Access Control) address)

This information displays the MAC address that is assigned to this unit.

Status (Network status)

This information displays the current link status of the network.

Display status: 10BASE-T, 100BASE-TX, Full Duplex, Half Duplex, No Link

Note

“No Link” appears when network connection is not made.

System (System ID)

This information displays the system ID that is assigned to this unit.

Manual Setup (Option)

This menu adjusts the optional system settings.

- 1 Set the operation mode selector to **AMP** and then press **SET MENU** on the remote control.
- 2 Press **▲ / ▽** to select “Manual Setup” and then press **▶**.
- 3 Press **▲ / ▽ / ◀ / ▶** to select “Option” and then press **▶**.

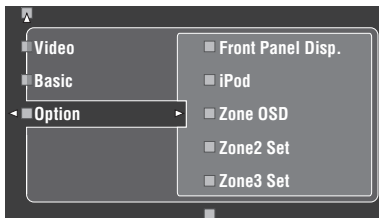

- 4 Select the desired parameters and then press **▶** to access and adjust.

■ Front Panel Disp. (Front panel display setting)

Dimmer (Dimmer)

Use this feature to adjust the brightness of the front panel display.

Control range: -4 to 0

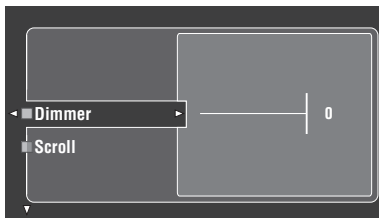

Scroll (Front panel display message scroll)

Use this feature to set whether to display the information (such as song title or channel name) in the front panel display in a continuous manner or by the first 14 alphanumeric characters after scrolling all characters once when “XM”, “DOCK” or “NET/USB” is selected as the input source.

Choice	Functions
Continue	Continuous mode. Select this to display the operation status in the front panel display in a continuous manner.
Once	Scroll-once mode. Select this to display the operation status in the front panel display by the first 14 alphanumeric characters after scrolling all characters once.

■ iPod (iPod settings)

Standby Charge

(iPod charge on the standby mode)

Use this feature to select whether this unit charges the battery of the stationed iPod or not when this unit is in the standby mode (see page 62).

Choice	Functions
Auto	Charges the battery of the stationed iPod when this unit is turned on and in the standby mode.
Off	Charges the battery of the stationed iPod only when this unit is turned on.

■ Zone OSD (On-screen display)

Use this feature to display the operational status of Zone 2 as well as Zone 3 on the Zone 2 video monitor connected to the ZONE VIDEO jacks on the rear panel of this unit. The Zone 2 and Zone 3 information to be displayed is listed as follows:

- The input source
- The volume level
- The audio mute status
- The tonal quality status
- The XM Satellite Radio information when XM is selected as the input source of Zone 2 and/or Zone 3

Choice	Functions
Off	Does not display any operational status of Zone 2 and Zone 3.
Zone2	Displays the operational status of Zone 2 only.
Zone2&Zone3	Displays the operational status of Zone 2 and Zone 3.

Notes

- You can connect up to two video monitors to the ZONE VIDEO jacks of this unit as the Zone 2 video monitors. If you connect two video monitors to the ZONE VIDEO jacks, these video monitors displays the same video images of the input source of Zone 2.
- When you set “Zone OSD” to “Zone2&Zone3”, the operational status of Zone 3 appears on the Zone 2 video monitor(s) even if Zone 2 is turned off.

■ Zone2 Set/Zone3 Set (Zone 2/Zone 3 setting)

Zone2 Amplifier/Zone3 Amplifier (Zone 2/Zone 3 amplifier)

Use to select how the Zone 2 or Zone 3 speakers are amplified.

Choice	Descriptions
EXT	Select this setting when the speakers in Zone 2 or Zone 3 are connected to the external amplifier and the external amplifier is connected to the ZONE OUT (ZONE 2 or ZONE 3) jacks of this unit. “Using external amplifiers” on page 117 for details.
INT:[SP1]	Select this setting when the speakers in Zone 2 or Zone 3 is connected to the SP1 speaker terminals of this unit directly. See “Using the internal amplifiers of this unit” on page 118 for details.
INT:[SP2]	Select this setting when the speakers in Zone 2 or Zone 3 is connected to the SP2 speaker terminals of this unit directly. See “Using the internal amplifiers of this unit” on page 118 for details.
INT:Both	Select this setting when the speakers in Zone 2 or Zone 3 are connected to both the SP1 and SP2 speaker terminals (for example, the speakers are connected via the bi-amplifier connection, or there are four speakers in a room) or if you want to play back the same source in Zone 2 and Zone 3 simultaneously. See “Using the internal amplifiers of this unit” on page 118 for details.

Notes

- When “BI-AMP” is set to “ON” in “ADVANCED SETUP” (see page 126), you can only set “Zone2 Amplifier” or “Zone3 Amplifier” to “EXT”.
- When you set “Zone2 Amplifier” or “Zone3 Amplifier” to “INT:[SP1]” and the corresponding zone is turned on, no sound is output from the surround back speakers.
- When you set “Zone2 Amplifier” or “Zone3 Amplifier” to “INT:[SP2]” in “ZONE 2” or “ZONE 3” and the corresponding zone is turned on, no sound is output from the surround speakers.
- When you set “Zone2 Amplifier” or “Zone3 Amplifier” to “INT:Both”, you can only set “AMP” to “EXT” in the other zone setting.
- When you set “Zone2 Amplifier” or “Zone3 Amplifier” to “INT:Both” and the corresponding zone is turned on, no sound is output from both the surround and surround back speakers.

Zone2 Volume/Zone3 Volume (Zone 2/Zone 3 volume)

Use this feature to select whether this unit controls the volume level of the audio signals output at the ZONE OUT (ZONE2 or ZONE3) jacks when you set “Zone2 Amplifier” or “Zone3 Amplifier” to “EXT”.

Choice	Descriptions
Fixed	Select this setting when you want to control the volume level of the selected zone on the external amplifier. This unit fixes the ZONE OUT (ZONE 2 or ZONE 3) volume level to a standard line level.
Variable	Select this setting when you want to control the volume level of the selected zone on this unit. You can adjust the ZONE OUT (ZONE 2 or ZONE 3) volume level simultaneously with Ⓜ VOLUME +/- on the remote control.

Zone2 Max Vol./Zone3 Max Vol. (Zone 2/Zone 3 Maximum volume)

Use this feature to set the maximum volume level in the Zone 2 or Zone 3.

Control range: -30.0 dB to +15.0 dB, **+16.5 dB**

Control step: 5.0 dB

Note

The “Zone2 Max Vol.” or “Zone3 Max Vol.” setting takes priority over the “Zone2 Initial Vol.” or “Zone3 Initial Vol.” setting. For example, “Zone2 Initial Vol.” is set to -20.0 dB and then “Zone2 Max Vol.” is set to -30.0 dB, the volume level is automatically set to -30.0 dB when you turn on the power of this unit next time.

Zone2 Initial Vol./Zone3 Initial Vol. (Zone 2/Zone 3 Initial volume)

Use this feature to set the volume level of Zone 2 or Zone 3 when the power of this unit is turned on.

Choices: **Off**, Mute, -80.0 dB to +16.5 dB

Control step: 0.5 dB

Note

The “Zone2 Max Vol.” or “Zone3 Max Vol.” setting takes priority over the “Zone2 Initial Vol.” or “Zone3 Initial Vol.” setting.

■ Audio Select (Default audio input jack select)

Use this feature to designate the default audio input jack select setting (see page 81) for the input sources connected to the DIGITAL INPUT jacks when you turn on the power of this unit.

Choice	Functions
Auto	Automatically detects the type of audio input signals and selects the appropriate audio input jack select setting.
Last	Automatically selects the last audio input jack select setting used for the connected input source.

■ Decoder Mode (Default decoder mode)

Use this feature to designate the default decoder mode (see page 82) for the input sources when you turn on the power of this unit.

Choice	Functions
Auto	Automatically detects the type of input signals and select the appropriate decoder mode setting.
Last	Automatically selects the last decoder mode setting used for the connected input source.

■ EXT D Surround (Default Extended surround setting)

Use this feature to designate the extended decoder mode (see page 88) for the input sources connected to the DIGITAL INPUT jacks when you turn on the power of this unit.

Choice	Functions
Auto	Automatically detects the input digital audio signals and activates the appropriate decoder.
Last	Automatically selects the last decoder mode selected "EXT D Surround" in "Sound".

■ Memory Guard (Memory guard)

Use this feature to prevent accidental changes to sound field program parameter values and other system settings.

Choice	Functions
Off	Turns off the "Memory Guard" feature.
On	Protects the following parameters <ul style="list-style-type: none"> – sound field program parameters – all GUI menu parameters – all speaker levels



When you select the protected parameter, "🔒" appears at the bottom left of the GUI screen. You can adjust the parameters when you select the parameter and "🔒" does not appear at the bottom left of the GUI screen even if "Memory Guard" is set to "On".

■ HDMI Set (HDMI settings)

Use this feature to adjust the HDMI support audio.

Support Audio (Support audio)

Use this feature to select whether to play back HDMI audio signals on this unit or on another HDMI component connected to the HDMI OUT jack on the rear panel of this unit.

Choice	Functions
RX-V3800	Plays back HDMI audio signals on this unit. The HDMI audio signals input at the HDMI input jacks of this unit are not output to the HDMI component connected to the HDMI OUT jack on the rear panel of this unit.
Other	Plays back HDMI audio signals on another HDMI component connected to the HDMI OUT jack.

Notes

- This unit transmits audio and video signals input at the HDMI input jacks to HDMI OUT jack only when this unit is turned on even if "Support Audio" is set to "Other".
- Available audio/video signals depend on the specification of the connected video monitor. Refer to the instruction manual of each connected component.

Signal Info. (Input signal information)

You can display the format, sampling frequency, channel, bit rate and flag data of the current input signal.

You can display the format, sampling frequency, channel, bit rate and flag data of the current input signal.

1 Set the operation mode selector to AMP and then press SET MENU on the remote control.

2 Press / repeatedly to select "Signal Info.".

The audio information of the current input source appears in the GUI screen.

3 Press / repeatedly to select "Audio Info." or "Video Info.".



The information is also appears in the front panel display. Press / repeatedly to change the displayed information.

■ Audio Info. (Audio information)

Format	Signal format. When this unit cannot detect a digital signal, it automatically switches to analog input.
Sampling	The number of samples per second taken from a continuous signal to make a discrete signal.
Channel	The number of source channels in the input signal (front/surround/LFE). For example, a multi-channel soundtrack with 3 front channels, 2 surround channels and LFE, is displayed as “3/2/0.1”.
Bitrate	The number of bits passing a given point per second.
Dialogue	The dialogue normalization level preset to the current input bitstream signal (see page 138).
Flag1/Flag2	Flag data encoded in the bitstream, or PCM signals that cue this unit to automatically switch decoders (“Surround EX”, etc.).

Notes

- “---” appears when this unit cannot display the corresponding information.
- Some high definition audio bitstream contents may not include the discrete surround back left and right channel signals but are encoded at the bitrate of 192 kHz.
- Even if you make settings to output bitstreams directly, some players convert the Dolby TrueHD or Dolby Digital Plus bitstreams to the Dolby Digital bitstreams, while converting the DTS-HD Master Audio or DTS-HD High Resolution Audio bitstreams to the DTS bitstreams.

■ Video Info. (Video information)

HDMI Signal	Type of the source video signals and the video signals output at the HDMI OUT jack of this unit.
HDMI Resolution	Resolution of the input signal (analog or HDMI) and the output signal (HDMI).
Analog Resolution	Resolution of the source video signals and the analog video signals output at the COMPONENT MONITOR OUT jacks of this unit.
HDMI Error (HDMI Message)	Error message for HDMI sources or connected HDMI devices. See page 131 for details.

Language

Use this feature to select the language of the menu items and messages that appears in the GUI (graphical user interface) screen of this unit.

Choices: **English** (English), 日本語 (Japanese), Français (French), Deutsch (German), Español (Spanish), Русский (Russian)



You can also select the GUI language using the “GUI LANGUAGE” parameter in “ADVANCED SETUP” in the front panel display (see page 126).

1 Set the operation mode selector to ⑭AMP and then press ⑰SET MENU on the remote control.

The top display appears.

2 Press ④∇ repeatedly to select “Language” and then press ④▷.



3 Press ④△ / ∇ repeatedly to select the language of your choice.

4 Press ④ENTER to confirm your selection.

Saving and recalling the system settings (System Memory)

Use this feature to save up to six of your favorite settings that can be easily recalled when needed. You can save the following system setting parameters:

Saved parameters	Page
“Stereo/Surround” parameters	74
“Volume” parameters (except “Initial Volume”)	84
“Sound” parameters* (except “EXTD Surround” and “Channel Mute”)	85
“Video” parameters (except “Short Message”)	89
“Basic” parameters	91
“Front Panel Disp.” parameters	96
“Support Audio”	98
Currently selected sound field program (or the Pure Direct mode)	45, 51
Tonal quality control settings*	51

* The settings of “Dynamic Range”, “LFE Level”, “Tone Control”, and the tonal quality control for headphones are not saved.

Saving the current system settings

Before performing the following operations, set the operation mode selector on the remote control to **AMP**.

■ Saving by the **SYSTEM MEMORY** buttons

You can save the system settings stored in “Memory1” to “Memory4” by pressing the corresponding **SYSTEM MEMORY** buttons.

Press and hold one of the **SYSTEM MEMORY buttons on the remote control for 4 seconds.**

“MEMORY 1 SAVE Done” (example) appears in the front panel display, and then this unit saves the current system settings to the corresponding memory number.

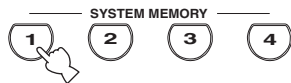

Note

If system settings are already saved in the selected memory number, this unit overwrites the old system settings.

■ Saving by the **SET MENU** operation

You can save the system settings stored in “Memory1” to Memory6” by using the “System Memory” menu in “SET MENU”.

1 Press **SET MENU on the remote control.**

The top menu appears in the GUI.

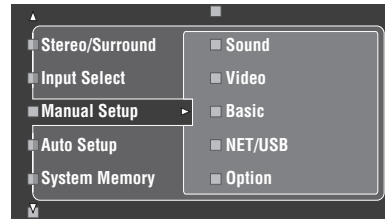

2 Press **UP / **DOWN** repeatedly to select “System Memory” and then press **RIGHT**.**

The “System Memory” menu appears in the GUI.

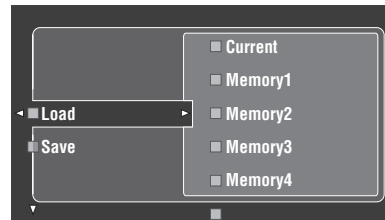

3 Press **UP / **DOWN** to select “Save” and then press **RIGHT**.**

The following menu appears in the GUI.

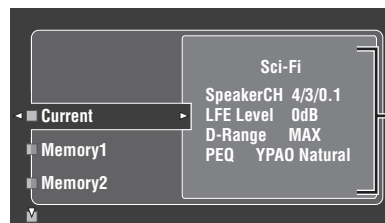

Current system parameters

- 4 Press **④**▲/▼ repeatedly to select the desired memory number (“Memory1” to “Memory6”) and then press **④**▶.

“Save: ENTER” appears in the GUI.

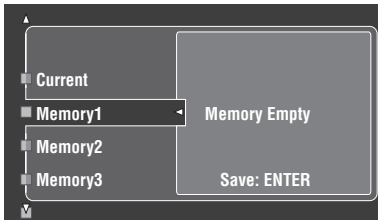

- If system settings are already stored in the selected memory number, the stored system parameter settings appear in the menu screen.
- If system settings are already saved in the selected memory number, this unit overwrites to old system settings.
- If you save the system settings to “Memory1” to “Memory4”, you can load the stored settings by pressing the corresponding **②④**SYSTEM MEMORY buttons (see page 101).

- 5 Press **④**ENTER to save the current system settings to the selected memory number.

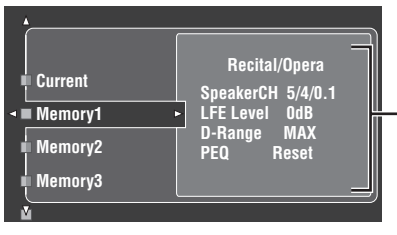

Stored system parameters in the selected memory number



You can cancel the saving by pressing **④**◀.

- 6 Press **⑰**SET MENU again to exit from GUI screen.

Loading the stored system settings

- Before performing the following operations, set the operation mode selector on the remote control to **⑩**AMP.
- This unit overwrites the stored settings to the current settings of this unit. If you do not want to erase the current settings, save the current settings to any System Memory number in advance.

■ Loading by the **②④**SYSTEM MEMORY buttons

You can recall the system settings stored in “Memory1” to “Memory4” by pressing the corresponding **②④**SYSTEM MEMORY buttons.

- 1 Press one of the **②④**SYSTEM MEMORY buttons on the remote control to select the desired memory number.

“MEMORY 1 LOAD” (example) appears in the front panel display.

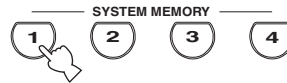

“EMPTY” appears in the front panel display if no system settings are stored in the selected memory number.

- 2 Press the selected **②④**SYSTEM MEMORY button once more to confirm the selection.

This unit loads the settings stored in the selected memory number.

■ **Loading by the SET MENU operation**

1 Press **Ⓜ** **SET MENU** on the remote control.
The top menu appears in the GUI.

2 Press **Ⓜ** **Δ** / **∇** repeatedly to select “System Memory” and then press **Ⓜ** **▷**.
The “System Memory” menu appears in the GUI.

3 Press **Ⓜ** **Δ** / **∇** to select “Load” and then press **Ⓜ** **▷**.
The following menu appears in the GUI.

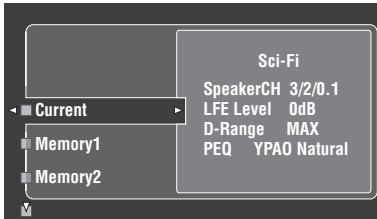

4 Press **Ⓜ** **Δ** / **∇** repeatedly to select the desired memory number where the system settings are stored and then press **Ⓜ** **▷**.

Once “Load: ENTER” appears in the GUI, press **Ⓜ** **ENTER** to confirm the loading.



You can cancel the loading by pressing **Ⓜ** **◀**.

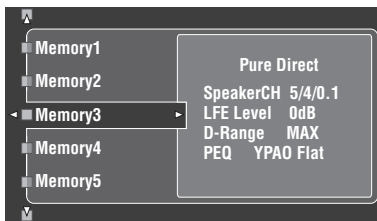

5 Press **Ⓜ** **SET MENU** to exit from GUI screen.

Using examples

■ **Example 1: Comparing the results of the automatic setup and manual setup**

This unit is equipped with three types of parametric equalizer settings (see page 40), and you can also make your customized configuration of the sound settings of this unit by using the “Manual Setup” parameters (see page 85). To compare the results of the automatic setup or your manual configuration, use the **Ⓜ** **SYSTEM MEMORY** buttons.

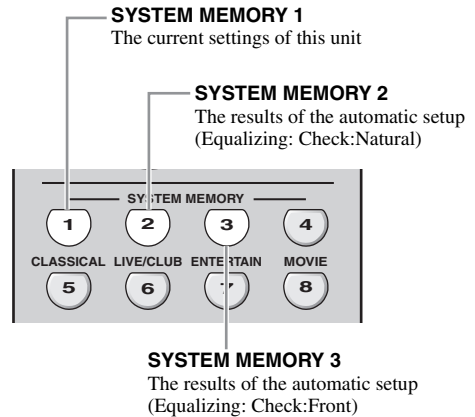

Saving each setting

Note

Carry out the following procedure when all the parameters are set to default values.

1 Press and hold **Ⓜ** **SYSTEM MEMORY 1** for four seconds.

This unit stores the current settings of this unit to “Memory1”.

2 Perform the automatic setup.

Set “Equalizing” to “Check:Natural”. See page 40 for details.

3 Press and hold **Ⓜ** **SYSTEM MEMORY 2** for 4 seconds.

This unit stores the results of the automatic setup performed in step 2 to “Memory2”.

4 Perform the automatic setup again.

This time, set “Equalizing” to “Check:Front”.

5 Press and hold **Ⓜ** **SYSTEM MEMORY 3** for 4 seconds.

This unit stores the results of the automatic setup performed in step 4 to “Memory3”.

Example 2: Switching the settings for different room environments

The tonal characteristics of the listening room may vary depending on the situations of the room (for example, whether the curtains are open or closed), and the settings of this unit should be arranged for each situation of the room. You can switch between the settings of this unit easily by using **SYSTEM MEMORY** buttons.

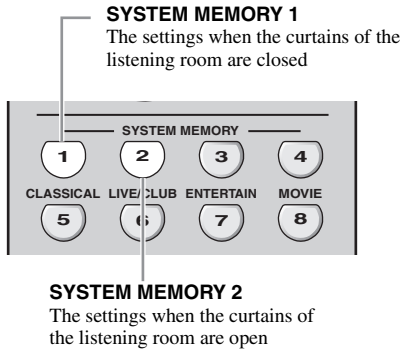

Example 3: Saving the sound configurations for specific sources

The desired sound configurations are different for each input source. For example, if you use the sound field program “Village Vanguard” for a music source of a live jazz performance, the parameter settings may differ when the input source is a vinyl record or an SACD. You can store the sound settings for each input source.

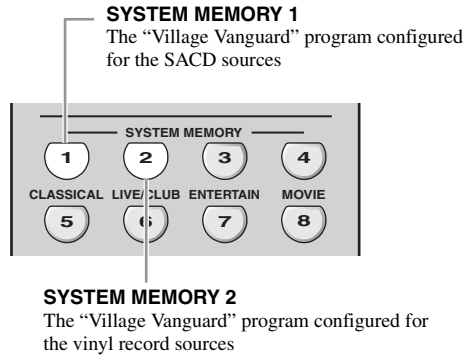

Saving each setting

- 1 Close the curtains of the listening room and then perform the automatic setup.**
See page 37 for details of the automatic setup.
- 2 Press and hold **SYSTEM MEMORY 1** for 4 seconds.**
This unit stores the settings for the current room situation (i.e. the curtains are closed) to “Memory1”.
- 3 Open the curtains of the listening room and the perform the automatic setup.**
- 4 Press and hold **SYSTEM MEMORY 2** for 4 seconds.**
This unit stores the current room situation (i.e. the curtains are open) to “Memory2”.

Saving each setting



See page 76 for the sound field program parameter settings.

- 1 Start playback of the desired live jazz performance recorded on the SACD.**
- 2 Set the sound field program to “Village Vanguard” and then adjust the parameters for the current playback sources.**
- 3 Press and hold **SYSTEM MEMORY 1** for 4 seconds.**
This unit stores the current sound field program settings to “Memory1”.
- 4 Change the input source to “PHONO” and then start playback of the desired live jazz performance recorded on the vinyl record.**
- 5 Adjust the sound field program parameters for the current playback source.**
- 6 Press and hold **SYSTEM MEMORY 2** for 4 seconds.**
This unit stores the current sound field program settings to “Memory2”.

■ **Example 4: Switching multiple audio and video synchronization settings**

If you use two different kinds of video monitors or projectors, and these components are not compatible with the automatic audio and video synchronization feature, you should set “Manual” in “Lipsync” for each component. You can switch between the different “Manual” in “Lipsync” settings by using the **SYSTEM MEMORY** buttons.

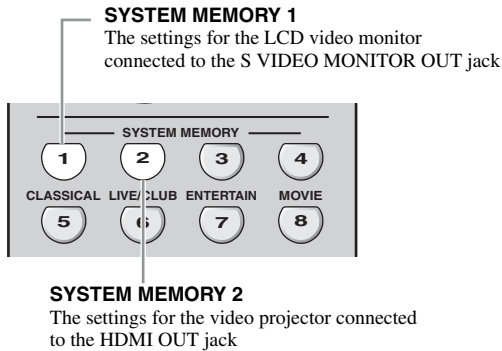

Saving each setting

Note

In the following example, the LCD video monitor and one input component (for example, VCR) are connected to the S VIDEO input jack and S VIDEO MONITOR OUT jack, and the video projector and the other input component (for example, DVD player) are connected to one of the HDMI IN jacks and HDMI OUT jack.

- 1 Start playback of the desired video source on the connected LCD video monitor and then adjust “Manual” in “Lipsync” appropriately (see page 87).**

- 2 Press and hold **SYSTEM MEMORY 1** for 4 seconds.**
This unit stores the audio and video synchronization settings for the LCD video monitor to “Memory1”.

- 3 Change the input source to the component connected to one of the HDMI IN jacks and then start playback.**

- 4 Adjust “Manual” in “Lipsync” appropriately.**

- 5 Press and hold **SYSTEM MEMORY 2** for 4 seconds.**
This unit stores the audio and video synchronization settings for the video projector to “Memory2”.

Remote control features

In addition to controlling this unit, the remote control can also operate other audiovisual components made by Yamaha and other manufacturers. To control your TV or other components, you must set up the appropriate remote control code for each input source (see page 107).

Controlling this unit, a TV, or other components

■ Controlling this unit

Set the operation mode selector to **AMP** to control this unit.

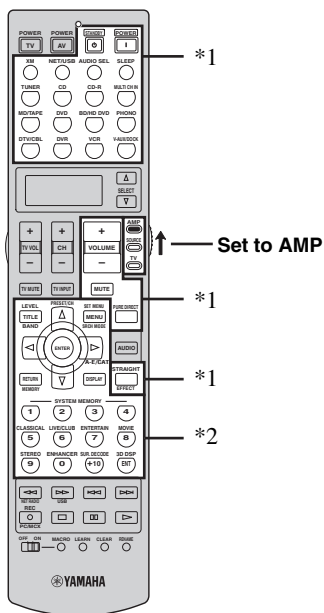

■ Controlling a TV

Set the operation mode selector to **TV** to control your TV. To control your TV, you must set the appropriate remote control code for DTV or PHONO (see page 107). When you set the remote control codes for both DTV and PHONO, priority is given to the one set for DTV.

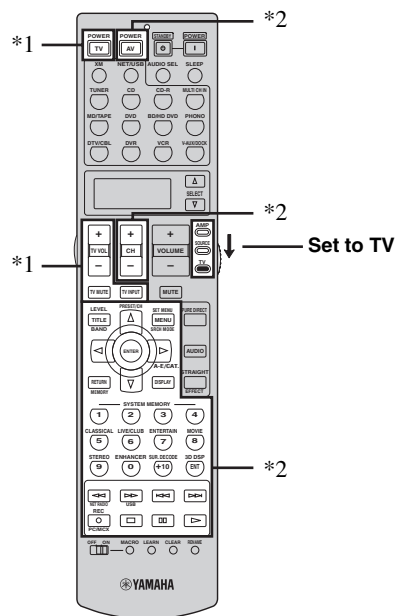

Notes

- *1 These buttons always control this unit regardless of the operation mode selector position.
- *2 These buttons control this unit only when the component operation mode selector is set to **AMP**.

Notes

- *1 These buttons always control your TV regardless of the operation mode selector position.

Remote control	Digital TV/Cable TV
TV POWER	Turns on or off the power.
TV VOL +/-	Increases or decreases the volume level.
TV MUTE	Mutes the audio output.
TV INPUT	Changes the input source.

- *2 These buttons control your TV only when the operation mode selector is set to **TV**. For details, see the "TV" column on page 106.

Controlling other components

Set the operation mode selector to **④SOURCE** to control other components selected with the input selector buttons (①). You must set the appropriate remote control code for each input source in advance (see page 107). The following table shows the function of each control button used to control other components assigned to each input selector button (①). Be advised that some buttons may not correctly operate the selected component.



The remote control has 14 modes (input areas) to control components so that the remote control can operate up to 14 different components.

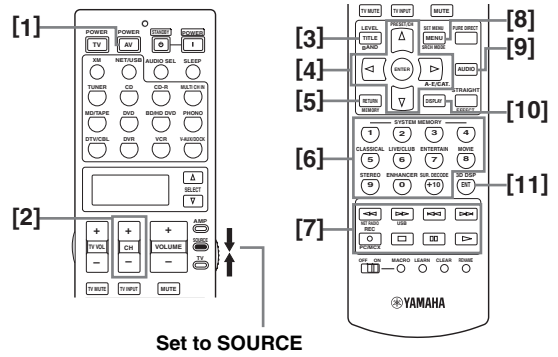

	Blu-ray Disc/ HD DVD player/ recorder	DVD player/ DVD recorder	VCR	Cable TV/ Satellite tuner	TV	LD player	CD player	MD recorder/ CD recorder	Tape deck	Tuner
[1] AV POWER	Power *1	Power *1	Power *1	Power *1	DVR power *2	Power *1	Power *1	Power *1	Power *1	Power *1
[2] CH +	TV channel up*3	TV channel up*3	Channel up	Channel up	Channel up	TV channel up*3	TV channel up*3	TV channel up*3	TV channel up*3	TV channel up*3
CH -	TV channel down*3	TV channel down*3	Channel down	Channel down	Channel down	TV channel down*3	TV channel down*3	TV channel down*3	TV channel down*3	TV channel down*3
[3] TITLE	Title	Title	Title	Title	Title					Band
[4] ENTER	Menu enter	Menu enter		Menu select	Menu select					
PRESET/CH Δ	Menu up	Menu up		Menu up	Menu up					Preset up (1 to 8)
PRESET/CH ∇	Menu down	Menu down		Menu down	Menu down					Preset down (1 to 8)
A-E/CAT. <	Menu left	Menu left		Menu left	Menu left					Preset down (A to E)
A-E/CAT. >	Menu right	Menu right		Menu right	Menu right				Direction A/B	Preset up (A to E)
[5] RETURN, MEMORY	Return	Return	Return	Return	Return					
[6] 1-9, 0, +10	Numeric buttons	Numeric buttons	Numeric buttons	Numeric buttons	Numeric buttons	Numeric buttons	Numeric buttons	Numeric buttons		
[7] <<<	Search backward	Search backward	Search backward	DVR search backward *2	DVR search backward *2	Search backward	Search backward	Search backward	Search backward	
>>>	Search forward	Search forward	Search forward	DVR search forward *2	DVR search forward *2	Search forward	Search forward	Search forward	Search forward	
<<<	Skip backward	Skip backward				Chapter/Skip backward	Skip backward	Skip backward	Direction back	
>>>	Skip forward	Skip forward				Chapter/Skip forward	Skip forward	Skip forward	Direction forward	
REC	Rec (recorder)	Disk skip (player) Rec (recorder)	Rec	DVR rec *2	DVR rec *2		Disc skip	Rec	Rec	
□	Stop	Stop	Stop	DVR stop *2	DVR stop *2	Stop	Stop	Stop	Stop	
⏸	Pause	Pause	Pause	DVR pause *2	DVR pause *2	Pause	Pause	Pause	Pause	
▶	Play	Play	Play	DVR play *2	DVR play *2	Play	Play	Play	Play	
[8] MENU	Menu	Menu		Menu	Menu					
[9] AUDIO	Audio	Audio				Audio				
[10] DISPLAY	Display	Display		Display	Display	Display	Display	Display		
[11] ENT			Enter	Enter/recall	Enter					

Notes

*1 This button is operational only when the original remote control supplied with the component has a POWER button.

*2 These buttons operate your video recorder (DVD recorder etc.) only when you set the appropriate remote control code for DVR (see page 107).

*3 These buttons always control your TV regardless of the operation mode selector position.

■ Selecting a component to be controlled

You can select a component to be controlled independently of the input source selected with the input selector buttons.

Press **SELECT** Δ / ∇ repeatedly to select the desired component.

The name of the component to be controlled appears in the display window (12) on the remote control.



■ Controlling optional components (Option mode)

“OPTN” is an optional component control area that can be programmed with remote control functions independently from any input source. This area is useful for programming commands that are to be used only as a part of a macro function or for components that do not have a valid remote control code.

To select the option mode, press **SELECT** ∇ repeatedly until “OPTN” appears in the display window (12) on the remote control.



Note

You cannot set a remote control code for the optional area. See page 109 to program buttons operated within this component control area.

Setting remote control codes

You can control other components by setting the appropriate remote control codes. Codes can be set up for each input area. For a complete list of available remote control codes, refer to “List of remote control codes” at the end of this manual.

The following table shows the default component (Library: component category) and the remote control code for each input area.

Remote control code default settings

Input area	Library (component category)	Manufacturer	Default code
XM	TUNER	Yamaha	2604
NET/USB	TUNER	Yamaha	2607
TUNER	TUNER	Yamaha	2602
CD	CD	Yamaha	2300
CD-R	CD-R	Yamaha	2400
MULTI CH IN	DVD	Yamaha	2100
MD/TAPE	MD	Yamaha	2500
DVD	DVD	Yamaha	2100
BD/HD DVD	DVD	Yamaha	2100
PHONO	TV	—	—
DTV/CBL	TV	—	—
DVR	DVR	Yamaha	2807
VCR	VCR	—	—
V-AUX/DOCK	TUNER	Yamaha	2606

Note

You may not be able to operate your Yamaha component even if a Yamaha remote control code is preset as listed above. In this case, try setting another Yamaha remote control code.

- 1 Set the operation mode selector to **⑭SOURCE** and then press an input selector button (①) to select the input area you want to set up.



- 2 Press and hold **ⓃLEARN** for about 3 seconds using a ballpoint pen or similar object.

The library name (ex. L;DVD) and the name of the selected input area (ex. DVD) appear alternately in the display window (⑫) on the remote control.

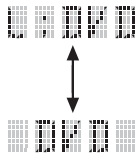

- You can set a remote control code of a different type of component to an input area. Press **④◀/▶** repeatedly to change the library (component category).
Library choices: L;DVD, L;DVR, L;LD, L;CD, L;CDR, L;MD, L;TAP (tape), L;TUN (tuner), L;AMP, L;TV, L;CAB (cable), L;SAT (satellite), L;VCR
- If you want to setup for another input area, press the input selector button, or press **ⓂSELECT ▲/▼** repeatedly to select the input area.

Notes

- Be sure to press and hold **ⓃLEARN** for at least 3 seconds, otherwise the learning process will start.
- If you do not complete each of the following steps within 30 seconds, the setting mode will be automatically canceled. In this case, start over from step 2.

- 3 Press **④ENTER**.

The four-digit code set for the selected component appears in the display window (⑫).

Note

“0000” appears in the display window (⑫) if no code has been set.

- 4 Press the numeric buttons (⑥) to enter the four-digit remote control code for the component you want to use.

For a complete list of available remote control codes, refer to “List of remote control codes” at the end of this manual.

- 5 Press **④ENTER** to set the number.

“OK” appears in the display window (⑫) on the remote control if setting was successful.
“NG” appears in the display window (⑫) on the remote control if the setting was unsuccessful. In this case, start over from step 3.



If you continuously want to set up another code for another component, press the input selector button, or **ⓂSELECT ▲/▼** repeatedly to select the component, then repeat steps 2 through 5.

- 6 Press **ⓃLEARN** again to exit from the setup mode.



- 7 Press **④▶** or **AV POWER** to confirm whether you can control your component using the remote control.



If operation is not possible and the manufacturer of your component has more than one code, try each of them until you find the correct one.

Notes

- “ERROR” appears in the display window (⑫) on the remote control if you press a button not indicated in the respective step, or when you press more than one button simultaneously.
- The supplied remote control does NOT contain ALL possible codes for commercially available audio and video components (including Yamaha components). If operation is not possible with any of the remote control codes, program the new remote control function using the learn feature (see “Programming codes from other remote controls” on page 109) or use the remote control supplied with the component.
- Functions programmed using the learn feature take priority over remote control code functions.

Programming codes from other remote controls

You can program remote control codes from other remote controls. Use the learn feature if you want to program functions not included in the basic operations covered by the remote control codes, or an appropriate remote control code is not available. You can program the function of other remote control to the buttons in the highlighted areas in the following illustration. The buttons can be programmed independently for each input area.

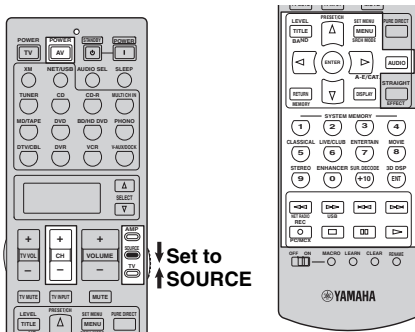

Note

The remote control transmits infrared rays. If the other remote control also uses infrared rays, this remote control can learn most of its functions. However, you may not be able to program some special signals or extremely long transmissions. Refer to the operating instructions for the other remote control.

- 1 Set the operation mode selector to **⑭SOURCE** and then press an input selector button (①) to select an input area.

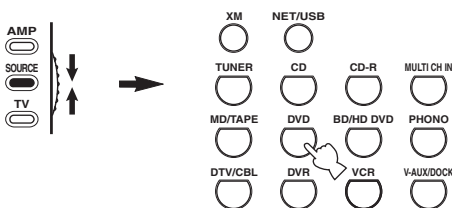

Note

Make sure that the operation mode selector is set to **⑭SOURCE**. When you set the operation mode selector to **⑭AMP** and program a remote control codes from other remote controls, the programmed key cannot operate the amplifier function of this unit.

- 2 Place this remote control about 5 to 10 cm (2 to 4 in) apart from the other remote control on a flat surface so that their infrared transmitters are aimed at each other.

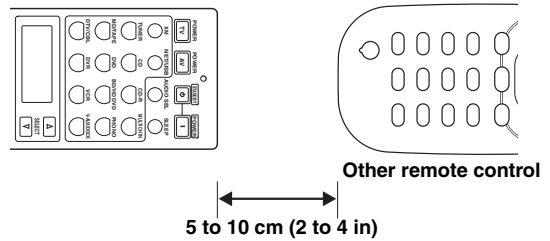

- 3 Press **ⓧLEARN** using a ballpoint pen or similar object.

“LEARN” and the name of the selected input area (ex. “DVD”) appear alternately in the display window (ⓧ) on the remote control.

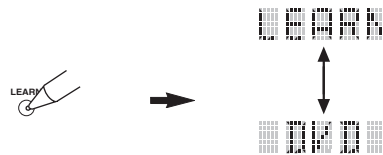

Notes

- Do not press and hold **ⓧLEARN**. If you hold it down for more than 3 seconds, the remote enters the remote control code setting mode.
- If you do not complete each of the following steps within 30 seconds, the learning mode will be automatically canceled. In this case, start over from step 3.

- 4 Press the button for which you want to program the new function. “LEARN” appears in the display window (ⓧ) on the remote control.



5 Press and hold the button you want to program on the other remote control until “OK” appears in the display window (12) on the remote control.

“NG” appears in the display window (12) on the remote control if learning was unsuccessful. In this case, start over from step 4.

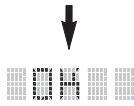
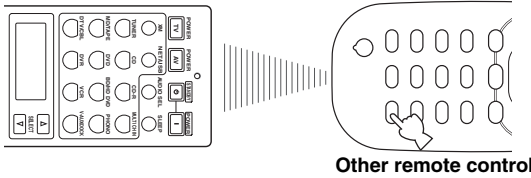

- If you want to program another function, repeat steps 4 and 5.
- If you continuously want to program another function for another component, press 12 **SELECT** Δ / ∇ to select the component, and then repeat steps 4 and 5.

6 Press 13 **LEARN again to exit the learning mode.**



Notes

- “ERROR” appears in the display window (12) on the remote control if you press a button not indicated in the respective step, or when you press more than one button simultaneously.
- This remote control can learn approximately 200 functions. However, depending on the signals learned, “FULL” may appear in the display before you program 200 functions. In this case, clear unnecessary programmed functions to make room for further learning.
- Learning may not be possible in the following cases:
 - when the batteries in the remote control for this unit or other components are weak.
 - when the distance between the two remote controls is too great or too small.
 - when the remote control infrared windows are not facing each other at the appropriate angle.
 - when the remote control is exposed to direct sunlight.
 - when the function to be programmed is continuous or uncommon.

Changing source names in the display window

You can change the name of the input source that appears in the display window (12) on the remote control if you want to use a different name from the factory preset. This feature is useful when you have set an input area to control a different component.

1 Set the operation mode selector to 14 **AMP or 14 **SOURCE** and then press an input selector button (1) to select the input area you want to rename.**

The name of the selected input area appears in the display window (12).

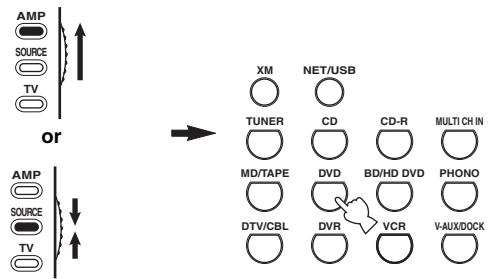

2 Press 15 **RENAME using a ballpoint pen or similar object.**



Note

If you do not complete each of the following steps within 30 seconds, the renaming mode will be automatically canceled. In this case, start over from step 2.

3 Press $\text{④}\Delta / \nabla$ to select and enter a character.

Pressing $\text{④}\nabla$ changes the character as follows:
A to Z, 1 to 9, 0, + (plus), - (hyphen), ; (semicolon),
/ (slash), and space. Pressing $\text{④}\Delta$ changes the
characters in reverse order.

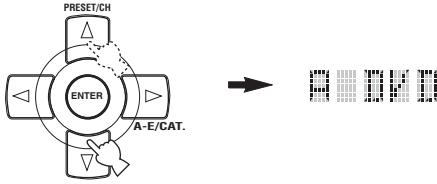

4 Press $\text{④}\triangleright$ to move the cursor to the next position.



Press $\text{④}\triangleleft$ to move the cursor to the previous position.

5 Press $\text{④}\text{ENTER}$ to set the new name.

“OK” appears in the display window (⑫) on the remote control if renaming was successful. “NG” appears in the display window (⑫) on the remote control if renaming was unsuccessful. In this case, start over from step 3.



If you continuously want to rename another input area, press the input selector button, or press $\text{⑫}\text{SELECT} \Delta / \nabla$ repeatedly to select the component, then repeat steps 3 through 5.

6 Press $\text{⑫}\text{RENAME}$ again to exit the renaming mode.



Note

“ERROR” appears in the display window (⑫) on the remote control if you press a button not indicated in the respective step, or when you press more than one button simultaneously.

Macro programming features

The macro programming feature makes it possible to perform a series of operations with the press of a single button. For example, when you want to play a CD, normally you would turn on the components, select the CD input, and press the play button to start playback. The macro programming feature lets you perform all of these operations simply by pressing the CD macro button. The buttons listed as macro buttons below are factory set with macro programs. You can also program your own macros (see page 113).

MACRO operations

Macro buttons

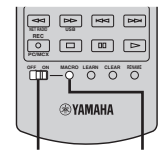
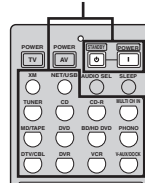

MACRO ON/OFF MACRO

1 Set the $\text{⑫}\text{MACRO ON/OFF}$ selector to ON.

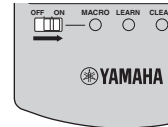

2 Press the desired macro button.

3 Set the $\text{⑫}\text{MACRO ON/OFF}$ selector to OFF when you finish to using the macro programming operation.

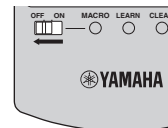

Notes

- While the remote control is running a macro program, it does not accept any other operation until it has completed running the program (the transmission indicator stops flashing).
- Continue to aim the remote control at the component the macro is operating until the macro operation is complete.

■ Default macro functions

Pressing macro button



To automatically transmit these signals in order		
First	Second	Third
	—	—
(*1)	(*2)	—
		—
		—
(*1)	(*3)	—
		(CD area) (*4)
		(CD-R area) (*4)
		—
		(MD/TAPE area) (*4)
		(DVD area) (*4)
		(BD/HD DVD area) (*4)
		—
		—
		(DVR area) (*4)
		(VCR area) (*4)
		—

- *1 You can turn on some components (including Yamaha components) connected to this unit by connecting them to the AC OUTLET(S) on the rear panel of this unit. Power control may not be synchronized with this unit depending on the component. For details, refer to the operating instructions for the connected component.
- *2 When the remote control code for your TV is set up for either DTV/CBL or PHONO (see page 107), you can turn on the power of your TV without selecting an input source. The remote control code set up for DTV takes priority over the one for PHONO.
- *3 When TUNER is selected as the input source, this unit plays the last station received before the unit was set in the standby mode.
- *4 Playback can be started for any Yamaha remote control-compatible MD recorder, CD player, CD recorder, DVD player, Blu-ray Disc player, HD DVD player or DVD recorder. When using macros to operate other components, you will need to program the play button on the input area of that component (see page 109) or set a remote control code (see page 107) in advance.

■ Programming macro operations

You can program your own macro and use the macro programming feature to transmit several remote control commands in sequence at the press of a button. Be sure to set up remote control codes or perform learning operations before programming the macro.

Notes

- The default macro is not cleared when a new macro is programmed for a button. The default macro can be used again when the programmed macro is cleared.
- It is not possible to add a new signal (macro step) to the default macro. Programming a macro changes all macro contents.
- We do not recommend programming continuous operations such as volume control in a macro.

1 Set the operation mode selector to ⑭ AMP or ⑭ SOURCE and then press ⑮ MACRO using a ballpoint pen or similar object.

“MCR ?” appears in the display window (⑫) on the remote control.

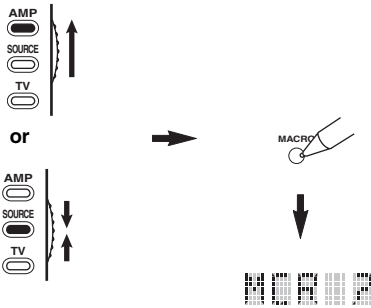

Note

If you do not complete each of the following steps within 30 seconds, the macro programming mode will be automatically canceled. In this case, start over from step 1.

2 Press the macro button you want to use to operate the macro.

The macro button name (ex. “M;DVD”) and the selected component name (ex. “DVD”) appear alternately in the display window (⑫) on the remote control.

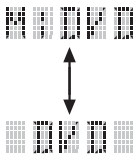

Note

“AGAIN” appears in the display window (⑫) if you press a button other than a macro button.

3 Press the buttons for the functions you want to include in the macro operation in sequence.

You can set up to 10 steps (10 functions). After you have set 10 steps, “FULL” appears and the remote control automatically exits the macro mode.

Example

Set the input source to DVD → Activate the DVD player → Set the sleep timer

Step 1 (“MCR 1”): Press DVD.

Step 2 (“MCR 2”): Press AV POWER.

Step 3 (“MCR 3”): Press SLEEP.

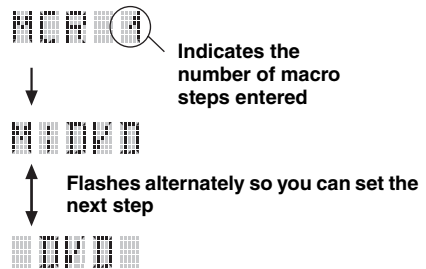
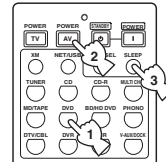

Note

To change the selected input area, press ⑯ SELECT Δ / ∇ . Pressing the input selector buttons will program a macro step, whereas ⑯ SELECT Δ / ∇ only changes the selected input area.

4 Press ⑮ MACRO again using a ballpoint pen or similar object when the operation sequence you want to program is complete.

Note

“ERROR” appears in the display window (⑫) if you press more than one button simultaneously.

Clearing configurations

You can clear all changes made in each function set, such as learned functions, macros, renamed input area names and setup remote control ID.

■ Clearing function sets

- 1 Set the operation mode selector to **AMP** or **SOURCE** and then press **CLEAR** by using a ballpoint pen or similar object.

“CLEAR” appears in the display window (⑫).

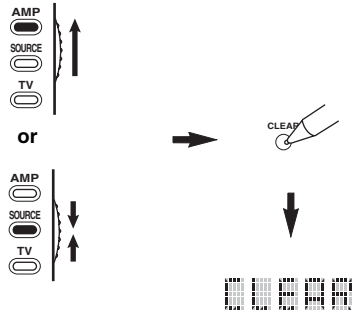

Note

If you do not complete each of the following steps within 30 seconds, the clearing mode will be automatically canceled. In this case, start over from step 1.

- 2 Press **△ / ▽** to select the clear mode.

L;CD (etc.)	(L; Name of an input area) Clears all learned functions in the respective input area. The name of a component is shown after a semicolon (;). Press an input selector button to select the input area.
L;AMP	Clears all learned functions for controlling the amplifier functions of this unit.
L;ALL	Clears all learned functions.
M;ALL	Clears all programmed macros.
RNAME	Clears all renamed source names.
FCTRY	Clears all remote functions and returns the remote to the factory settings.

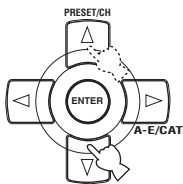

- 3 Press and hold **CLEAR** again for about 3 seconds.

“WAIT” appears in the display window (⑫). If clearing was successful, “C:OK” appears in the display window (⑫) on the remote control.



Once you have cleared a learned function for a button, the button reverts to the factory setting (or to the manufacturer setting, if you have set remote control codes).

Notes

- “L;ALL” and “FCTRY” may take about 30 seconds to complete.
- “C;NG” appears in the display window (⑫) if clearing was unsuccessful. In this case start over from step 2.
- “ERROR” appears in the display window (⑫) if you press a button not indicated in the respective step, or if you press more than one button simultaneously.

- 4 Press **CLEAR** again to exit.

■ Clearing a learned function

You can clear the function learned for a certain button in each control area.

1 Set the operation mode selector to **AMP** or **SOURCE** and then press an input selector button (1) to select the input area containing the function you want to clear.

The selected component name appears in the display window (12).

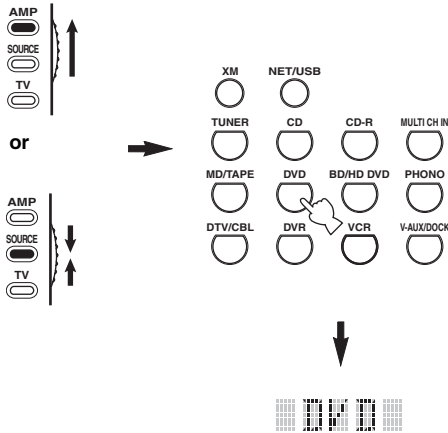

3 Press and hold **CLEAR** using a ballpoint pen or similar object and then press the button you want to clear for about 3 seconds.

“C:OK” appears in the display window (12) if clearing was successful. Once “C:OK” appears in the display window (12) on the remote control, release the ballpoint pen or similar object used to press **CLEAR** to exit the clearing mode. The remote control returns to the learning mode.

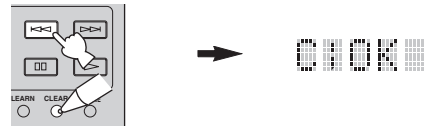

- If you continuously want to clear another function, repeat step 3.
- If you continuously want to clear another function for another component, press **SELECT** Δ / ∇ to select the input area, and then repeat step 3.
- Once you clear a learned function, the button reverts to the factory setting (or to the manufacturer setting if you have set remote control codes).

2 Press **LEARN** using a ballpoint pen or similar object.

“LEARN” and the selected component name (ex. “DVD”) appear alternately in the display window (12).

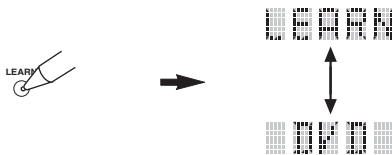

Notes

- Do not press and hold **LEARN**. If you hold it down for more than 3 seconds, the remote control enters the remote control code setting mode.
- If you do not complete each of the following steps within 30 seconds, the learning mode will be automatically canceled. In this case, start over from step 2.

4 Press **LEARN** again to exit.

Notes

- “C:NG” appears in the display window (12) on the remote control if clearing was unsuccessful. In this case, start over from step 2.
- “ERROR” appears in the display window (12) if you press more than one button simultaneously.

■ Clearing a macro function

You can clear the function programmed for a certain macro button.

- 1 Set the operation mode selector to **AMP** or **SOURCE** and then press **MACRO** using a ballpoint pen or similar object.

“MCR ?” appears in the display window (12) on the remote control.

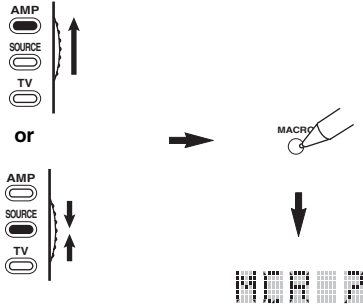

Note

If you do not complete each of the following steps within 30 seconds, the macro programming mode will be automatically canceled. In this case, start over from step 1.

- 2 Press and hold **CLEAR** using a ballpoint pen or similar object, then press the macro button you want to clear for about 3 seconds.

“C;OK” appears in the display window (12) on the remote control if clearing was successful.

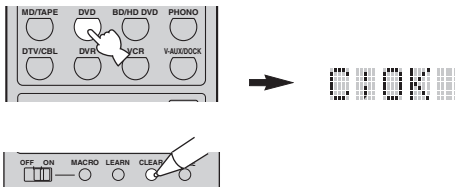

- If you continuously want to clear another function, repeat step 2.
- Once you clear a programmed function, the button reverts to the factory setting (or to the manufacturer setting if you have set remote control codes).

- 3 Press **MACRO** again to exit the macro programming mode.

Notes

- “C;NG” appears in the display window (12) on the remote control if clearing was unsuccessful. In this case, start over from step 2.
- “ERROR” appears in the display window (12) on the remote control if you press more than one button simultaneously.

Using multi-zone configuration

This unit allows you to configure a multi-zone audio/video system. The multi-zone configuration feature enables you to set this unit to reproduce separate input sources in the main zone, second zone (Zone 2) and third zone (Zone 3). You can control this unit from the second or third zone using the supplied remote control.

Connect the source component to the analog audio input jacks of this unit to play back the source in Zone 2 or Zone 3. This unit does not output the audio signals input at the DIGITAL INPUT and HDMI jacks to the ZONE OUT jacks.

Connecting the Zone 2 and Zone 3 components

You need the following additional equipment to use the multi-room functions of this unit:

- An infrared signal receiver in Zone 2 and/or Zone 3.
- An infrared emitter in the main room. This emitter transmits the infrared signals from the remote control in Zone 2 and/or Zone 3 to the main room (to a CD player or DVD player, for example).
- An amplifier and speakers for Zone 2 and/or Zone 3.
- A video monitor for the second room

- ☀
- You do not need an extra amplifier and speakers for Zone 2 and/or Zone 3 if you want to use the internal amplifiers of this unit.
 - Since there are many possible ways to connect and use this unit in a multi-zone configuration, we recommend that you consult with your nearest authorized Yamaha dealer or service center for the Zone 2 and Zone 3 connections that best meet your requirements.

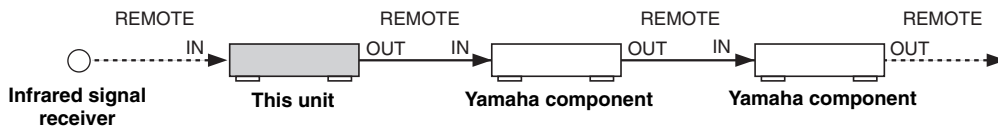

■ Using external amplifiers

To use an external amplifier in Zone 2 or Zone 3, connect the external amplifier to ZONE OUT terminals and select “EXT” in “Zone2 Amplifier” or “Zone3 Amplifier” (see page 97).

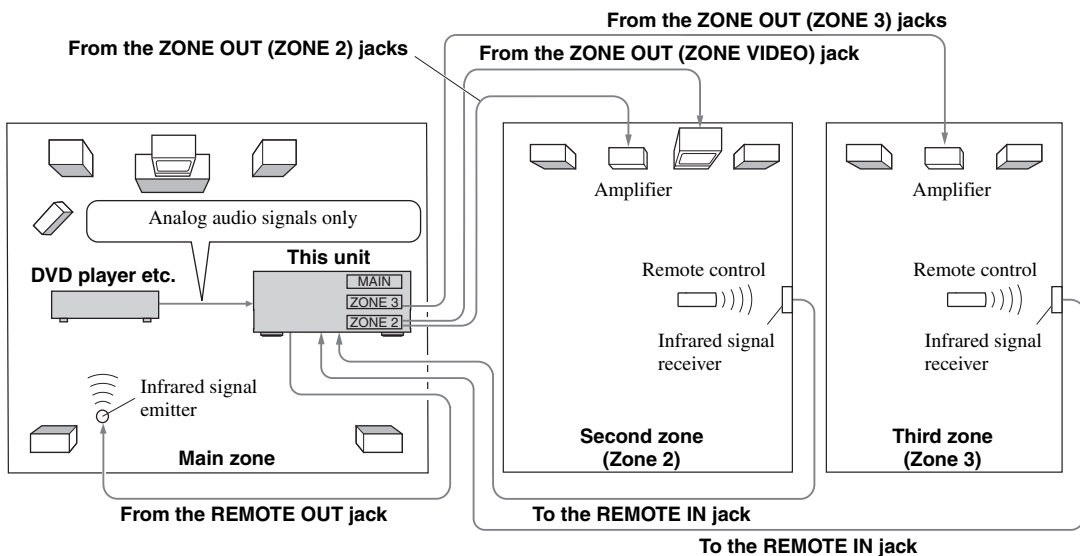

Notes

- To avoid unexpected noise, DO NOT use the Zone 2/Zone 3 feature with CDs encoded in DTS.
- Adjust the Zone 2/Zone 3 volume by using the amplifier in the second/third room when “Zone2 Volume” or “Zone3 Volume” are set to “Fixed” (see page 97).

■ Using the internal amplifiers of this unit

Important safety notice

The SP1 or SP2 speaker terminals of this Receiver should not be connected to a Passive Loudspeaker Selector Box or more than one loudspeaker per channel.

Connection to a Passive Loudspeaker Selector Box or multiple speakers per channel could create an abnormally low impedance load resulting in amplifier damage. See this owner's manual for correct usage.

Compliance with minimum speaker impedance information for all channels must be maintained at all times. This information is found on the back panel of your Receiver.

If you want to use one internal amplifier (SP1 or SP2) of this unit

Connect the Zone 2 or Zone 3 speakers directly to the SP1 or SP2 speaker terminals and select either "INT:[SP1]" or "INT:[SP2]" for "Zone2 Amplifier" or "Zone3 Amplifier" (see page 97).

If you want to use two internal amplifiers (SP1 and SP2) of this unit

Connect the Zone 2 and Zone 3 speakers directly to the SP1 and SP2 speaker terminals and select "Both" for "Zone2 Amplifier" or "Zone3 Amplifier" (see page 97).

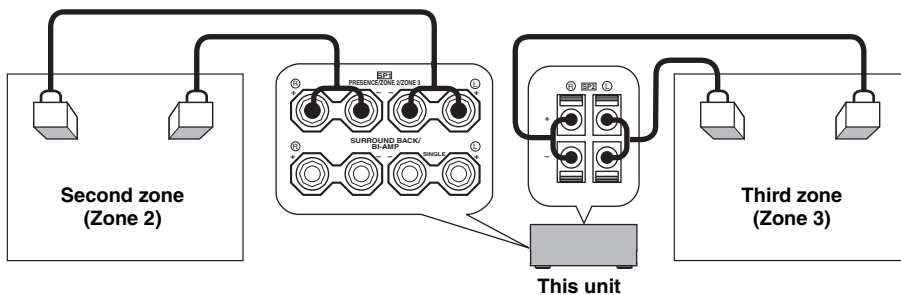

Controlling Zone 2 or Zone 3

You can select the zone you want to control by using the control buttons on the front panel or on the remote control.

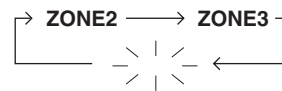

No indicator flashes when the main zone is selected.

■ Selecting Zone 2 or Zone 3

Front panel operations

- 1 Press **@ZONE 2 ON/OFF** or **@ZONE 3 ON/OFF** on the front panel to individually turn on or off Zone 2 or Zone 3.
- 2 Press **@ZONE CONTROLS** on the front panel repeatedly to select the zone you want to control.
Each time you press **@ZONE CONTROLS**, the front panel display changes as shown below, and the indicator for the currently selected zone flashes for approximately 10 seconds. However, no indicator flashes when the main zone is selected.

ZONE2

Controls the Zone 2 amplifier or tuner functions.

ZONE3

Controls the Zone 3 amplifier or tuner functions.



- You must complete this step within 10 seconds while the selected zone flashes in the front panel display. Otherwise, the currently selected zone mode is automatically canceled. In this case, press **@ZONE CONTROLS** again.
- The initial setting is ZONE2 when both Zone 2 and Zone 3 are turned on.

- 3** Refer to “Selecting the input source of Zone 2 or Zone 3”, “Adjusting the volume level of Zone 2 or Zone 3”, “Adjusting the balance of the speaker level in Zone 2 or Zone 3” or “Adjusting the tonal quality of Zone 2 or Zone 3” on page 120 to perform further operations.

Remote control operations

- 1** Set the operation mode selector to **⑭ AMP** and then press **⑫ SELECT** Δ repeatedly to select the zone you want to control. “ZONE 2” or “ZONE 3” is displayed in the display window (⑫) on the remote control.

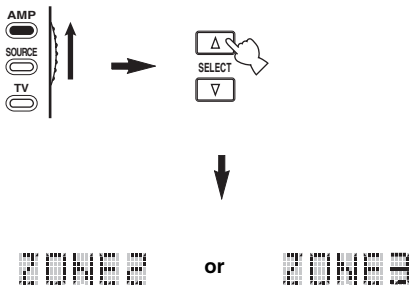

- 2** Refer to “Selecting the input source of Zone 2 or Zone 3”, “Adjusting the volume level of Zone 2 or Zone 3”, “Adjusting the balance of the speaker level in Zone 2 or Zone 3” or “Adjusting the tonal quality of Zone 2 or Zone 3” on page 120 to perform further operations.

- 3** Press **⑫ SELECT** Δ / ∇ to exit from the Zone 2/Zone 3 mode.

Turning on or off Zone 2 and/or Zone 3 using the remote control

⑨ POWER and **⑧ STANDBY** on the remote control work differently depending on the selected zone that appears in the display window (⑫) on the remote control.

- When the main zone, Zone 2 or Zone 3 mode is selected (see page 119), you can turn on the main zone, Zone 2 or Zone 3 or set them to the standby mode individually.
- When the all mode is selected, pressing **⑨ POWER** turns on the main zone, Zone 2 and Zone 3 simultaneously and pressing **⑧ STANDBY** sets them to the standby mode simultaneously.

Control mode	Display window (⑫)	POWER and STANDBY
Main zone mode	Name of the selected input area	Turns on the main zone only or sets it to the standby mode.
Zone 2 mode	“ZONE 2” or “2;name of the selected input area”	Turns on Zone 2 or sets it to the standby mode.
Zone 3 mode	“ZONE 3” or “3;name of the selected input area”	Turns on Zone 3 or sets it to the standby mode.
All mode	“ALL”	⑨ POWER: turns on the main zone, Zone 2 and Zone 3. ⑧ STANDBY: sets the main zone, Zone 2 and Zone 3 to the standby mode.

Notes

- When the remote control is in the main zone mode, “MAIN” appears for a few seconds when **⑨ POWER** or **⑧ STANDBY** is pressed.
- “ALL” appears in the display window (⑫) on the remote control only when **⑫ SELECT** ∇ is pressed.

Selecting the input source of Zone 2 or Zone 3

Rotate the **③ INPUT** selector on the front panel (or set the operation mode selector to **⑭ AMP** and then press one of the input selector buttons (①)) to select the input source of the selected zone.

If the remote control is used to select the input source, “2; name of the selected input area” or “3; name of the selected input area” is displayed in the display window (⑫) on the remote control when Zone 2 or Zone 3 is selected respectively.

Notes

- The selected input sources are shared across all zones.
- If you set the recording source other than “SOURCE” (see page 70), the input source of Zone 2 is fixed to the source you set as the recording source.
- This unit does not display the iPod or network/USB menu on the video monitor connected to one of the ZONE VIDEO jacks.



- You must complete this step within 10 seconds while the selected zone flashes in the front panel display. Otherwise, the currently selected zone mode is automatically canceled. In this case, press **③ ZONE CONTROLS** on the front panel again.
- When a video monitor is connected to one of the ZONE VIDEO jacks, you can display the control information of Zone 2 or Zone 3 and XM Satellite Radio information on the video monitor screen. Set “Zone OSD” to “Zone2&Zone3” or “Zone2” (see page 96).

Operate the following operations after activating the Zone 2 or Zone 3 operation mode.

■ Adjusting the volume level of Zone 2 or Zone 3

Rotate **VOLUME** on the front panel (or press **VOLUME +/-**) to adjust the volume level of the selected zone.



Press **MUTE** on the remote control to mute the sound output to the selected zone.

Note

When you use the external amplifiers in Zone 2 or Zone 3, **VOLUME +/-** can be used only when “Zone2 Volume” or “Zone3 Volume” is set to “Variable” in “Zone2 Set” or “Zone3 Set” (see page 97).

■ Adjusting the balance of the speaker level in Zone 2 or Zone 3

Press **TONE CONTROL** repeatedly to select “BALANCE” and then rotate **PROGRAM** to adjust the balance of the front left and right speaker level of the selected zone.

■ Adjusting the tonal quality of Zone 2 or Zone 3

Set the operation mode selector to **AMP** and then press **CH +/-** on the remote control to adjust the high-frequency response (TREBLE) or **TV VOL +/-** to adjust the low-frequency response (BASS) respectively.

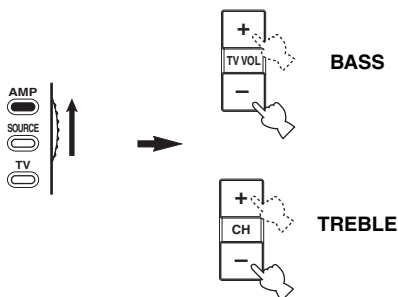

You can also adjust the tonal quality of Zone 2 or Zone 3 by using **TONE CONTROL** on the front panel. For details, see “Adjusting the tonal quality” on page 51.

Note

Check that “ZONE 2” or “ZONE 3” is displayed in the display window (12) of the remote control before you adjust the tonal quality of the corresponding zone (see page 119).

■ Using Zone 2/Zone 3 remote control

You can control Zone 2 or Zone 3 features by using the supplied Zone 2/Zone 3 remote control. First, set the ID1/ID2 switch and ZONE 2/ZONE 3 switch appropriately.

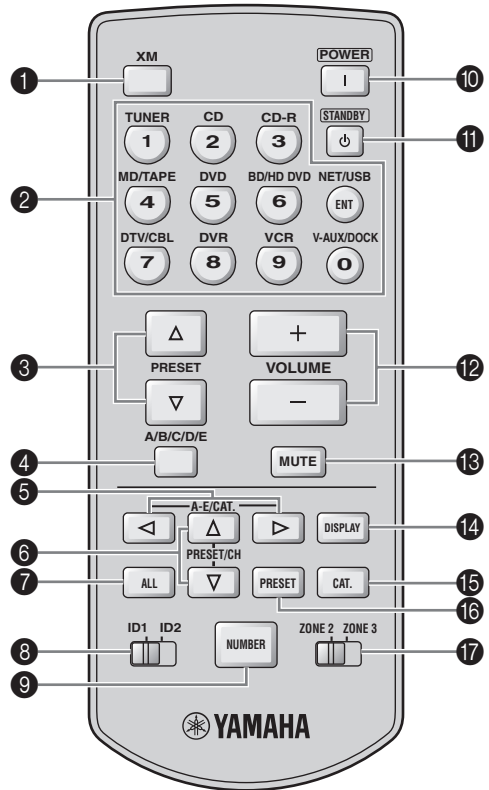

Controlling the amplifier function

1 XM

Selects XM as the input source of the controlling zone.

2 Input selector buttons

Selects the desired input source for the controlling zone.

8 ID1/ID2 switch

Switches the remote control ID between ID1 and ID2 (see page 124).

10 POWER

Turns on Zone 2 or Zone 3.

Note

This button is operational only when **MASTER ON/OFF** on the front panel is pressed inward to the ON position.

11 STANDBY

Sets Zone 2 or Zone 3 to the standby mode.

Note

This button is operational only when **MASTER ON/OFF** on the front panel is pressed inward to the ON position.

12 VOLUME +/-

Increases or decreases the volume level of Zone 2 or Zone 3.

13 MUTE

Mutes the sound of Zone 2 or Zone 3. Press again to restore the audio output to the previous volume level.

17 ZONE 2/ZONE 3 switch

Switches between the operation mode of Zone 2 and that of Zone 3.

Controlling the tuner function (see page 53)

Select "TUNER" as the input source of the controlling zone to use the following functions

3 PRESET Δ / ∇

Selects one of the 8 preset station numbers (1 to 8) when the colon (:) is displayed in the front panel display (see page 55).

4 A/B/C/D/E

Selects one of the preset station groups (A to E) (see page 55).

Controlling the XM Satellite Radio tuning function (see page 56)

Select "XM" as the input source of the controlling zone to use the following functions.

2 Numeric buttons**(All Channel Search or Category Search mode)**

Use 1 to 9 and 0 to enter a channel number directly.

(Preset Search mode)

Use 1 to 8 to enter a preset channel number directly.



While holding down **9 NUMBER** (see page 121), press the numeric buttons to enter the desired channel numbers directly when this unit is in the All Channel Search or Category Search mode.

5 A-E/CAT. \triangleleft / \triangleright **(All Channel Search mode)**

Changes the channel category.

(Category Search mode)

Changes the channel category.

(Preset Search mode)

Changes the preset channel group (A to E).

6 PRESET/CH Δ / ∇ **(All Channel Search mode)**

Searches for a channel within all channels. Press and hold for quick search.

(Category Search mode)

Searches for a channel within the selected category. Press and hold for quick search.

(Preset Search mode)

Changes the preset channel number (1 to 8).

7 ALL

Selects the All Channel Search mode as the search mode (see page 58).

9 NUMBER

Press and hold before you press the numeric buttons to switch the function to entering the three-digit channel number in the All channel Search mode or Category Search mode (see page 58).

14 DISPLAY

Displays the XM Satellite Radio information such as channel number, channel name, category, artist name, or song title displayed in the front panel display or on the video monitor (see page 60).

15 CAT.

Selects the Category Search mode as the search mode (see page 58).

16 PRESET

Selects the Preset Search mode as the search mode (see page 58).

Advanced setup

This unit has additional menus that are displayed in the front panel display. The advanced setup menu offers additional operations to adjust and customize the way this unit operates. Change the initial settings (indicated in bold under each parameter) to reflect the needs of your listening environment.

Notes

- The settings you make are reflected next time you press **Ⓐ MASTER ON/OFF** inward to the ON position to turn on this unit (see page 33).
- Only **Ⓐ MASTER ON/OFF**, **Ⓟ STRAIGHT** and the **Ⓞ PROGRAM** selector are effective while you are using the advanced setup menu.
- All the other operations cannot be made while you are using the advanced setup menu.
- The advanced setup menu is only available in the front panel display.

Using the advanced setup menu

- 1 Press **Ⓐ MASTER ON/OFF** on the front panel to release it outward to the OFF position to turn off this unit.**
- 2 Press and hold **Ⓟ STRAIGHT** on the front panel and then press **Ⓐ MASTER ON/OFF** inward to the ON position to turn on this unit.**
This unit turns on, and the advanced setup menu appears in the front panel display.
- 3 Rotate the **Ⓞ PROGRAM** selector on the front panel to select the parameter you want to adjust.**
The name of the selected parameter appears in the front panel display.
- 4 Press **Ⓟ STRAIGHT** on the front panel repeatedly to change the selected parameter setting.**
- 5 Press **Ⓐ MASTER ON/OFF** on the front panel to release it outward to the OFF position to save the new setting and turn off this unit.**



The settings you made are reflected next time you turn on this unit.

■ Speaker impedance **SPEAKER IMP.**

Use this feature to set the speaker impedance of this unit so that it matches that of your speakers.

Choices: **8ΩMIN**, **6ΩMIN**

- Select “8ΩMIN” to set the speaker impedance to 8 Ω .
- Select “6ΩMIN” to set the speaker impedance to 6 Ω .

SPEAKER IMP.	Speaker	Impedance level
8ΩMIN	Front	The impedance of each speaker must be 8 Ω or higher.
	Center	The impedance of each speaker must be 8 Ω or higher.
	Surround	
	Surround back	
6ΩMIN	Front	The impedance of each speaker must be 4 Ω or higher.
	Center	The impedance of each speaker must be 6 Ω or higher.
	Surround	
	Surround back	

■ Remote sensor **REMOTE SENSOR**

Use this feature to activate or deactivate the signal-receiving capability of the remote control sensor on the front panel of this unit.

Choices: **ON**, **OFF**

- Select “ON” if you want to activate the signal-receiving capability of the remote control sensor.
- Select “OFF” if you want to deactivate the signal-receiving capability of the remote control sensor.

Note

We recommend setting the parameter to “ON” in most cases.

Wake on RS-232C access

RS-232C STANDBY

Use this feature to set this unit to transmit data via the RS-232C interface when this unit is in the standby mode.

Choices: YES, NO

Initial setting:

[U.S.A. and Canada models]: YES

[Other models]: NO

- Select “YES” to set this unit to transmit data via the RS-232C interface.
- Select “NO” to set this unit not to transmit data via the RS-232C interface.

Remote control AMP ID

RC AMP ID

Use this feature to set the AMP ID of this unit for remote control recognition.

Choices: ID1, ID2

- Select “ID1” when the remote control AMP ID library code is set to “2001”.
- Select “ID2” when the remote control AMP ID library code is set to “2002”.

Setting remote control AMP ID code

1 Set the operation mode selector to **AMP** or **SOURCE**.

2 Press and hold **LEARN** for about 3 seconds using a ballpoint pen or similar object and then press **ENTER** repeatedly until “L;AMP” appears in the display window **(12)** on the remote control.

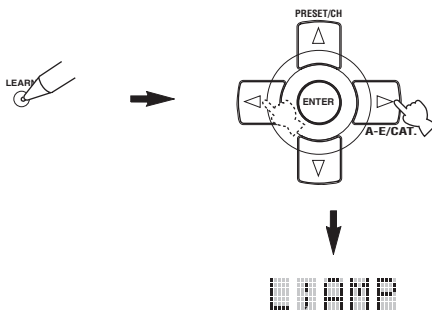

Notes

- Be sure to press and hold **LEARN** for at least 3 seconds, otherwise the learning process will start.
- If you do not complete each of the following steps within 30 seconds, the setting mode will be automatically canceled. In this case, start over from step 2.

3 Press **ENTER**.

The four-digit code set for the selected input area appears in the display window **(12)** on the remote control.

4 Press the numeric buttons **(6)** to enter the four-digit remote control AMP ID code for the input area you want to use.

Remote control AMP ID code*1	Function	RC AMP ID*2
2001 (initial setting)	Operates this unit using the default code.	ID1 (initial setting)
2002	Operates this unit using an alternative code.	ID2

*1 The remote control setting.

*2 The setting of this unit.

5 Press **ENTER** to set the number.

“OK” appears in the display window **(12)** if the setting was successful.

“NG” appears in the display window **(12)** if the setting was unsuccessful. In this case, start over from step 2.

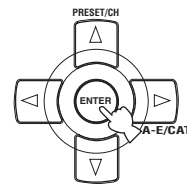

6 Press **LEARN** again to exit from the setup mode.



■ Remote control TUNER ID

RC TUNER ID

Use this feature to set the TUNER ID of this unit for remote control recognition.

Choices: **ID1**, ID2

- Select "ID1" when the remote control TUNER ID library code is set to "2602".
- Select "ID2" when the remote control TUNER ID library code is set to "2603".

Setting remote control TUNER ID

1 Set the operation mode selector to **AMP** or **SOURCE** and then press **TUNER** on the remote control to select the tuner to change the remote control ID.

2 Press and hold **LEARN** for about 3 seconds using a ballpoint pen or similar object until "L;TUN" and "TUNER" alternately appear in the display window (12).



Notes

- Be sure to press and hold **LEARN** for at least 3 seconds, otherwise the learning process will start.
- If you do not complete each of the following steps within 30 seconds, the setting mode will be automatically canceled. In this case, start over from step 2.

3 Press **ENTER**.

The four-digit code set for the selected input area appears in the display window (12) on the remote control.

4 Press the numeric buttons (6) to enter the four-digit remote control code for the input area you want to use.

Remote control TUNER ID code*1	Function	RC TUNER ID*2
2602 (initial setting)	Operates this unit using the default code.	ID1 (initial setting)
2603	Operates this unit using an alternative code.	ID2

*1 The remote control setting.

*2 The setting of this unit.

5 Press **ENTER** to set the number.

"OK" appears in the display window (12) if the setting was successful.

"NG" appears in the display window (12) if the setting was unsuccessful. In this case, start over from step 2.

6 Press **LEARN** again to exit from the setup mode.



■ Remote control XM ID RC XM ID (U.S.A. and Canada models only)

Use this feature to set the XM ID of this unit for remote control recognition.

Choices: ID1, ID2

- Select "ID1" when the remote control XM ID library code is set to "2604".
- Select "ID2" when the remote control XM ID library code is set to "2605".

Setting remote control XM ID

1 Set the operation mode selector to **⑭ AMP** or **⑭ SOURCE** and then press **① XM** on the remote control to select the XM to change the remote control ID.

2 Press and hold **Ⓝ LEARN** for about 3 seconds using a ballpoint pen or similar object until "L;TUN" and "XM" alternately appear in the display window (⑫) on the remote control.



Notes

- Be sure to press and hold **Ⓝ LEARN** for at least 3 seconds, otherwise the learning process will start.
- If you do not complete each of the following steps within 30 seconds, the setting mode will be automatically canceled. In this case, start over from step 2.

3 Press **④ ENTER**.

The four-digit code set for the selected input area appears in the display window (⑫) on the remote control.

4 Press the numeric buttons (⑥) to enter the four-digit remote control code for the input area you want to use.

Remote control XM ID code*1	Function	RC XM ID*2
2604 (initial setting)	Operates this unit using the default code.	ID1 (initial setting)
2605	Operates this unit using an alternative code.	ID2

*1 The remote control setting.

*2 The setting of this unit.

5 Press **④ ENTER** to set the number.

"OK" appears in the display window (⑫) if the setting was successful.

"NG" appears in the display window (⑫) if the setting was unsuccessful. In this case, start over from step 2.

6 Press **Ⓝ LEARN** again to exit from the setup mode.



See page 122 for the operation of the advanced setup.

■ Tuner frequency step TUNER FRQ STEP (Asia and General models only)

Use this feature to set the tuner frequency step according to the frequency spacing in your area.

Choices: AM10/FM100, **AM9/FM50**

- Select “AM10/FM100” for North, Central and South America.
- Select “AM9/FM50” for all other areas.

■ Bi-amplifier setting BI-AMP

Use this feature to activate or deactivate the bi-amplifier function.

Choices: ON, **OFF**

- Select “ON” if you want to activate the bi-amplifier function.
- Select “OFF” if you want to deactivate the bi-amplifier function.

Note

When “BI-AMP” is set to “ON”, the SURROUND BACK terminals cannot be used to connect surround back speakers in that the SURROUND BACK terminals are already used for the bi-amplifier connection (see page 19).

■ Parameter initialization INITIALIZE

Use this feature to reset the parameters of this unit to the initial factory settings. You can select the category of parameters to be initialized.

Choices: DSP PARAM, VIDEO, NETWORK, ALL, **CANCEL**

- Select “DSP PARAM” to initialize all the parameters of the sound field parameters (see page 74).
- Select “VIDEO” except “Short Message” and “On Screen” (see page 90).
- Select “NETWORK” to initialize the network and USB parameters (see page 94).
- Select “ALL” to initialize all the parameters of this unit.
- Select “CANCEL” to cancel the initialization procedure.

Notes

- Use “Initialize” in the sound field program menu to initialize the parameters of the desired program (see page 80).
- When the network settings are reset, “DHCP” in “NET/USB” is automatically set to “On” (see page 94) and the registered client ID of this unit on your Yamaha MCX-2000 is cleared (see page 67).

■ TV format TV FORMAT

Use this feature to set the color encoding format of your television.

Choices: NTSC, PAL

Initial setting:

[U.S.A., Canada, General and Korea models]: NTSC

[Other models]: PAL

Note

This parameter setting only affects the video monitor connected to the MONITOR OUT jacks and does not affect the Zone 2 video monitor connected to the ZONE 2 VIDEO jacks.

■ HDMI monitor check

MONITOR CHECK

Use this feature to activate or deactivate the monitor check function of this unit. When “MONITOR CHECK” is set to “YES”, this unit receives the information of the available video signal resolutions from the video monitor connected via HDMI and you can only select the resolutions supported by the video monitor in “HDMI Resolution” (see page 90). When “MONITOR CHECK” is set to “SKIP”, you can select any resolution in “HDMI Resolution”.

Choices: **YES**, SKIP

■ GUI language GUI LANGUAGE

Use this feature to select the language of your choice that appears in the GUI (graphical user interface) menu of this unit.

Choices: **ENGLISH** (English), JAPANESE (Japanese), FRENCH (French), GERMAN (German), SPANISH (Spanish), RUSSIAN (Russian)

Troubleshooting

Refer to the table below when this unit does not function properly. If the problem you are experiencing is not listed below or if the instruction below does not help, turn off this unit, disconnect the power cable, and contact the nearest authorized Yamaha dealer or service center.

■ General

Problem	Cause	Remedy	See page
This unit fails to turn on or enters the standby mode soon after the power is turned on.	The power cable is not connected or the plug is not completely inserted.	Connect the power cable firmly.	—
	The speaker impedance setting is incorrect.	Set the speaker impedance to match your speakers.	33
	The protection circuitry has been activated.	Make sure that all speaker wire connections on this unit and on all speakers are secure and that the wire for each connection does not touch anything other than its respective connection.	15
	This unit has been exposed to a strong external electric shock (such as lightning or strong static electricity).	Set this unit to the standby mode, disconnect the power cable, plug it back in after 30 seconds and then use it normally.	—
No sound.	Incorrect input or output cable connections.	Connect the cables properly. If the problem persists, the cables may be defective.	23-30
	Audio input jack select is set to “HDMI”, “COAX/OPT” or “ANALOG”.	Set the audio input jack select to “AUTO”.	42
	Audio input jack select is set to “ANALOG” while the input source component outputs digital audio signals.	Set the audio input jack select to “AUTO” or “COAX/OPT”.	42
	No appropriate input source has been selected.	Select an appropriate input source with the ⒸINPUT selector on the front panel (or the input selector buttons Ⓛ) on the remote control).	41, 42
	Speaker connections are not secure.	Secure the connections.	15
	The volume is turned down.	Turn up the volume.	—
	The sound is muted.	Press ⓂMUTE or ⓇVOLUME +/- on the remote control to resume audio output and then adjust the volume.	43
	Signals this unit cannot reproduce are being input from a source component, such as a CD-ROM.	Play a source whose signals can be reproduced by this unit.	—
	The HDMI components connected to this unit do not support the HDCP copy protection standards.	Connect HDMI components that support the HDCP copy protection standards.	21
	“Support Audio” is set to “Other” and “HDMI” audio signals are not being played back on this unit.	Set “Support Audio” to “RX-V3800” in “Option”.	98
No picture.	The output and input for the picture are connected to different types of video jacks.	Set “Conversion” to “On” or connect your source components in the same way as you connect your video monitor to this unit.	89
	This unit outputs the video signals are not supported on the video monitor connected to the HDMI OUT jack.	Set the “INITIALIZE” to “VIDEO” to reset the video parameters.	126
		Set “MONITOR CHECK” to “YES”.	126
	Pure Direct mode is active.	Turn off the Pure Direct mode.	51
Non-standard video signals are input.			

Problem	Cause	Remedy	See page
Short message displays do not appear in the video monitor.	“Short Message” is set to “Off”.	Set “Short Message” to “On”.	90
	“Conversion” is set to “Off”.	Set “Conversion” to “On”.	89
	The signals input at the HDMI input jacks are being output at the HDMI OUT jack.		
	HDTV video signals are being input.		
The sound suddenly goes off.	The protection circuitry has been activated because of a short circuit, etc.	Check that the speaker impedance setting is correct. Check that the speaker wires are not touching each other and then turn this unit back on.	33, 122 —
	The sleep timer has turned off this unit.	Turn on this unit, and play the source again.	—
	The sound is muted.	Press MUTE or VOLUME +/- on the remote control to resume audio output.	43
Sound is heard from the speaker on one side only.	Incorrect cable connections.	Connect the cables properly. If the problem persists, the cables may be defective.	15
	Incorrect settings in “Speaker Level”.	Adjust the “Speaker Level” settings.	94
Only the center speaker outputs substantial sound.	When playing a monaural source with a CINEMA DSP program, the source signal is directed to the center channel, and the front and surround speakers output effect sounds.		
No sound is heard from the center speaker.	“Center” in “Speaker Set” is set to “None”.	Set “Center” to “Small” or “Large”.	92
	One of the HiFi DSP programs (except for “7ch Stereo”) has been selected and analog 2-channel source is being input	Try another sound field program if you want to output sound from the center speaker.	45
No sound is heard from the presence speakers.	The sound field programs are turned off.	Press STRAIGHT to turn them on.	50
	You are using a source or program combination that does not output sound from all channels.	Try another sound field program.	41
No sound is heard from the surround speakers.	“Surround” in “Speaker Set” is set to “None”.	Set “Surround” to “Small” or “Large”.	92
	This unit is in the “STRAIGHT” mode and a monaural source is being played back.	Press STRAIGHT on the front panel so that “STRAIGHT” disappears from the front panel display.	50
No sound is heard from the subwoofer.	“Bass Out” in “Speaker Set” is set to “Front” when a Dolby Digital or DTS signal is being played.	Set “Bass Out” to “SWFR” or “Both”.	92
	“Bass Out” in “Speaker Set” is set to “SWFR” or “Front” when a 2-channel source is being played.	Set “Bass Out” to “Both”.	92
	The source does not contain low-frequency signals.		
No sound is heard from the surround back speakers.	“Surround” in “Speaker Set” is set to “None” and “Surround Back” is automatically set to “None”.	Set “Surround” and “Surround Back” to a setting other than “None”.	92
	“Surround Back” in “Speaker Set” is set to “None”.	Set “Surround Back” to a setting other than “None”.	92
	CINEMA DSP 3D mode is active.	Set the CINEMA DSP 3D mode to “OFF”.	50

Problem	Cause	Remedy	See page
The audio input sources cannot be played in the desired digital audio signal format. (Desired input source indicator or decoder indicator in the front panel display does not light up.)	The connected component is not set to output Dolby Digital or DTS digital signals.	Make an appropriate setting following the operating instructions for your component.	—
	Audio input jack select is set to "ANALOG".	Set the audio input jack select to "AUTO".	42
A humming sound is heard.	Incorrect cable connections.	Connect the audio cables firmly. If the problem persists, the cables may be defective.	—
	No connection from the turntable to the GND terminal.	Connect the grounding cable of the turntable to the GND terminal of this unit.	27
The volume level is low while a record is being played.	The record is being played on a turntable with an MC cartridge.	Connect the turntable to this unit through an MC-head amplifier.	27
The volume level cannot be increased, or the sound is distorted.	The component connected to the AUDIO OUT (REC) jacks of this unit is turned off.	Turn on the power of the component.	—
The sound effect cannot be recorded.	It is not possible to record the sound effect with a recording component.		
A source cannot be recorded by a digital recording component connected to the DIGITAL OUTPUT jack.	The source component is not connected to the DIGITAL INPUT jacks of this unit.	Connect the source component to the DIGITAL INPUT jacks.	24, 27
	Some components cannot record Dolby Digital or DTS sources.		
A source cannot be recorded by an analog component connected to the AUDIO OUT (REC) jacks.	The source component is not connected to the analog AUDIO IN jacks of this unit.	Connect the source component to the analog AUDIO IN jacks.	27
The sound field parameters and some other settings of this unit cannot be changed.	"Memory Guard" in "Option" is set to "On".	Set "Memory Guard" to "Off".	98
This unit does not operate properly.	The internal microcomputer has been frozen by an external electric shock (such as lightning or excessive static electricity) or by a power supply with low voltage.	Disconnect the power cable from the AC wall outlet and then plug it in again after about 30 seconds.	—
"CHECK SP WIRES" appears in the front panel display.	Speaker cables are short-circuited.	Make sure all speaker cables are connected correctly.	15
There is noise interference from digital or radio frequency equipment.	This unit is too close to the digital or high-frequency equipment.	Move this unit further away from such equipment.	—
The picture is disturbed.	The video source uses scrambled or encoded signals to prevent dubbing.		
This unit suddenly enters the standby mode.	The internal temperature becomes too high and the overheat protection circuitry has been activated.	Wait about 1 hour for this unit to cool down and then turn it back on.	—

■ Tuner

	Problem	Cause	Remedy	See page
FM	FM stereo reception is noisy.	The characteristics of FM stereo broadcasts may cause this problem when the transmitter is too far away or the antenna input is poor.	Check the antenna connections.	32
			Try using a high-quality directional FM antenna.	—
			Use the manual tuning method.	53
	There is distortion, and clear reception cannot be obtained even with a good FM antenna.	There is multi-path interference.	Adjust the antenna position to eliminate multi-path interference.	—
The desired station cannot be tuned into with the automatic tuning method.	The signal is too weak.	Use a high-quality directional FM antenna.	—	
		Use the manual tuning method.	53	
Previously preset stations can no longer be tuned into.	This unit has been disconnected for a long period.	Preset the stations again.	54	
AM	The desired station cannot be tuned into with the automatic tuning method.	The signal is weak or the antenna connections are loose.	Tighten the AM loop antenna connections and orient it for the best reception.	—
			Use the manual tuning method.	53
	There are continuous crackling and hissing noises.	Supplied AM loop antenna is not connected. Noises can result from lightning, fluorescent lamps, motors, thermostats and other electrical equipment.	Connect the AM loop antenna correctly even if you use an outdoor antenna.	32
			Use an outdoor antenna and a ground wire. This will help somewhat, but it is difficult to eliminate all noise.	—
There are buzzing and whining noises.	A TV set is being used nearby.	Move this unit away from the TV set.	—	

■ XM Satellite Radio (U.S.A. and Canada models only)

If an operation takes longer than usual or an error occurs, one of the following messages may appear in the front panel display. In this case, read the cause and follow the corresponding remedies.

Status message	Cause	Remedy	See page
CHECK ANTENNA	XM Mini-Tuner and Home Dock are not connected to the XM jack of this unit or do not work properly.	Check XM Mini-Tuner and Home Dock connections and orient for the best reception level.	56
UPDATING	The XM user encryption code is being updated.	Wait until the encryption code is updated.	—
NO SIGNAL	The signal is too weak.	Adjust the orientation of the antenna of Home Dock for the best reception level.	56
LOADING	It takes longer than 4 seconds for audio or text data to be decoded.	Wait until the decoding process has finished.	—
OFF AIR	The XM Satellite Radio channel you selected is not currently broadcasting any signals.	Check the channel number again or select another XM Satellite Radio channel.	—
<XM> ---	The Channel Station ID (SID) is no longer available.		
--- / ---	No artist name or song title is available.		
<CAT> ---	No channels are available for the selected category.	Select another channel category by pressing ⓄCATEGORY on the front panel (or ⓄA-E/CAT. < /▷ on the remote control) repeatedly.	58

■ Remote control

Problem	Cause	Remedy	See page
The remote control does not work or function properly.	Wrong distance or angle.	The remote control will function within a maximum range of 6 m (20 ft) and no more than 30 degrees off-axis from the front panel.	34
	Direct sunlight or lighting (from an inverter type of fluorescent lamp, etc.) is striking the remote control sensor of this unit.	Reposition this unit.	—
	The batteries are weak.	Replace all batteries.	5
	The batteries do not last long and get quickly exhausted.	Using alkaline batteries is strongly recommended.	—
	The operation mode selector is set incorrectly.	Set the operation mode selector correctly. When operating this unit, set it to the AMP position. When operating the component selected by the input selector button, set it to the SOURCE position. When operating the TV set in the DTV or PHONO area, set it to the TV position.	—
	The remote control code was not correctly set.	Set the remote control code correctly using “List of remote control codes” at the end of this manual.	107
		Try setting another code of the same manufacturer using “List of remote control codes” at the end of this manual.	107
The library code of the remote control and the remote control ID of this unit do not match.	Match the remote control ID of this unit with the corresponding remote control library code.	107	
The remote control does not work or function properly.	Even if the remote control code is correctly set, there are some models that do not respond to the remote control.	Program the necessary functions independently into the programmable buttons using the Learn feature.	109
The remote control does not learn new functions.	The batteries of this remote control and/or the other remote control are too weak.	Replace the batteries.	5
	The distance between the two remote controls is too much or too little.	Place the remote controls at the proper distance.	109
	The signal coding or modulation of the other remote control is not compatible with this remote control.	Learning is not possible.	—
	Memory capacity is full.	Delete other unnecessary functions to make room for the new functions.	114

■ HDMI

Error message	Cause	Remedy	See page
Device Over	The number of the connected HDMI components is over the limit.	Reduce the number of the connected HDMI components.	—
HDCP Error	HDCP authentication failed.	Check that the connected HDMI components support the HDCP copy protection standards.	—

HDMI Message	Cause	Remedy	See page
Out of Resolution	The connected monitor is not compatible with the resolution of the input video signal or input video signal is the analog component video signal with 1080p of resolution.	Set the resolution of the video output signal of the input source component appropriately.	—

■ Network and USB

Problem	Cause	Remedy	See page
The PC server/MCX-2000/Internet Radio does not function properly.	The IP address is not set properly.	Set the DHCP server function of the router to ON. Alternately, perform manual configuration according to the current operating environment.	94
	The network cable is not connected.	Connect it properly.	31
The music in the PC server cannot be played back.	The PC does not have Windows Media Player 11 or Windows Media Connect 2.0 installed in it.	Install Windows Media Player 11 or Windows Media Connect 2.0 in the PC.	—
	The music is recorded in a format that cannot be played on this unit. This unit cannot play music formats other than WMA, MP3 and WAV (PCM format). Also note that it cannot play certain music files even if these are recorded in the WMA, MP3 or WAV format.	Play music recorded in a format that this unit is compatible with.	—
	The music is copyright-protected.	This unit cannot play copyright-protected music.	—
Windows Media Player 11 or Windows Media Connect 2.0 cannot be connected.	The Windows XP PC is logging on to a domain.	Log on to the local machine instead of the domain.	—
The MusicCAST server cannot be connected.	You are attempting to connect to MCX-1000. The MusicCAST server that can be connected by this unit is MCX-2000.	Use MCX-2000 or the PC server.	—
	Auto Configuration is not executed.	Execute "Auto Configure".	66
"Disconnected" is displayed even when a USB device is present.	This unit recognized the USB device as an illegal device.	Turn this unit off then on again.	68
The Internet Radio cannot be played.	The firewall of the network device is activated. The Internet Radio can be played only when it passes through the port designated by each radio station. The port number is variable depending on radio station.	Check the firewall setting of the network device.	—
	Connection to the Internet is disconnected.	Check the configuration of the network device, and then contact the network connection provider.	—
The music files and directories in the USB device cannot be viewed.	The music files and directories are placed in locations other than the FAT area.	Place music files and directories in the FAT area.	—
	You are attempting to browse directory hierarchies of over 8 levels or a directory with more than 500 files.	Modify the data structure on your USB device.	—

Problem	Cause	Remedy	See page
The USB device cannot be recognized.	The connected USB device is other than a USB mass storage class USB memory device or USB portable audio player.	This unit can recognize only a USB mass storage class USB memory device or USB portable audio player. Also note that it cannot recognize certain USB devices even when they are devices as described above.	68
		Some devices may become easier to recognize when they are inserted before turning this unit on.	68
This unit does not recall the correct item by using numeric buttons (1-8).	The connected USB device is incorrect.	Connect the USB device that stores the preset item.	68
	The directory that stores the selected item is changed.	Preset the desired item to the numeric button (1-8) again.	68
This unit does not recall the selected item by using numeric buttons (1-8).	The USB device is not connected correctly.	Connect the correct USB device properly.	68
	The PC or MCX-2000 that stores the selected item is turned off.	Turn on the PC or MCX-2000.	66
	The selected Internet Radio station is temporary unavailable or out of service.	Try again when the selected Internet Radio is providing the service.	67
		Preset other Internet Radio stations.	68
Status message	Cause	Remedy	See page
Please wait	This unit is in the middle of recognizing the connection with your network.	This is not a system malfunction. Wait for a while.	—
	This unit is in the middle of recognizing the connection with your USB memory device or USB portable audio player.	This is not a system malfunction. Wait for a while.	—
Please wait (Starting Server)	This unit is in the middle of waking up MCX-2000 that has been set to the standby mode.	Wait for approximately 20 seconds.	—
Connect error	There is a problem with the signal path from your network to this unit.	Check the connection between this unit and the LAN port on your router or hub.	31
		Make sure your router is properly connected and turned on. Also, make sure your modem is properly connected and turned on when you are attempting to listen to Internet Radio.	31
Disconnected	Your USB memory device or USB portable audio player has been disconnected from the USB port of this unit.	Check the connection between this unit and your USB memory device or USB portable audio player.	—
	The PC server or MCX-2000 previously connected to this unit no longer exists.	Connect this unit to the available PC server or MCX-2000.	66
	There is a problem with the signal path from your USB memory device or USB portable audio player to this unit.	Turn off this unit and reconnect your USB memory device or USB portable audio player to the USB port of this unit.	33
Try resetting your USB memory device or USB portable audio player.		—	

Status message	Cause	Remedy	See page
Access error	This unit cannot access your USB memory device or USB portable audio player.	Try another USB memory device or USB portable audio player.	—
	There is a problem with the signal path from your USB memory device or USB portable audio player to this unit.	Turn off this unit and reconnect your USB memory device or USB portable audio player to the USB port of this unit.	33
Unable to play	This unit cannot play back the songs currently stored on your PC.	Try resetting your USB memory device or USB portable audio player.	—
		Make sure Windows Media Connect 2.0 is installed on your PC.	—
Unable to play	The network may be overloaded with heavy traffic, and playback is interrupted.	Check that the songs currently stored on your PC are playable (MP3, WMA, and WAV).	—
		Store some other playable music files (MP3, WMA, and WAV) on your PC.	—
		Try preparing a network exclusively for use with this unit to separate it from general network traffic.	—
List updated	The list of the contents stored on your PC server or MCX-2000 has been updated.		
Bookmark ON	The desired Internet Radio station has been added to the "Bookmarks" list.		
Bookmark OFF	The stored Internet Radio station has been removed from the "Bookmarks" list.		
Empty Memory!	No items are assigned to the selected numeric button.	Assign the desired item to the numeric button.	68
Not found!	This unit cannot find the assigned item for the selected numeric button.	Connect the USB device that stores the preset item.	68
		Turn on the PC or MCX-2000.	66
		Try again when the selected Internet Radio is providing the service.	67
		Preset the desired item to the numeric button (1-8) again.	68

■ iPod

Note

In case of a transmission error without a status message appearing in the front panel and on the video monitor, check the connection to your iPod (see page 30).

Status message	Cause	Remedy	See page
Loading...	This unit is in the middle of recognizing the connection with your iPod.		
	This unit is in the middle of acquiring song lists from your iPod.		
Connect error	There is a problem with the signal path from your iPod to this unit.	Turn off this unit and reconnect the Yamaha iPod universal dock to the DOCK terminal of this unit.	30
		Try resetting your iPod.	—
Unknown iPod	The iPod being used is not supported by this unit.	Only iPod (Click and Wheel), iPod nano, and iPod mini are supported.	—
iPod connected	Your iPod is properly stationed in a Yamaha iPod universal dock (such as the YDS-10, sold separately) connected to the DOCK terminal of this unit, and the connection between your iPod and this unit is complete.		
Disconnected	Your iPod was removed from a Yamaha iPod universal dock (such as YDS-10 sold separately) connected to the DOCK terminal of this unit.	Station your iPod back in a Yamaha iPod universal dock (such as YDS-10 sold separately) connected to the DOCK terminal of this unit.	30
Unable to play	This unit cannot play back the songs currently stored on your iPod.	Check that the songs currently stored on your iPod are playable.	—
		Store some other playable music files on your iPod.	—

■ Auto Setup

Before Auto Setup

Error message	Cause	Remedy	See page
Connect MIC!	Optimizer microphone is not connected.	Connect the supplied optimizer microphone to the OPTIMIZER MIC jack on the front panel.	37
Unplug Phones!	Headphones are connected.	Unplug the headphones.	—
No Setup Menu!	All setup menu are set to “Skip”.	Set the desired menu item to “Check”.	39
Memory Guard!	“Memory Guard” is set to “On”.	Set “Memory Guard” to “Off”.	98

During Auto Setup

Error message	Cause	Remedy	See page
E01:No Front SP	Front L/R channel signals are not detected.	Check the front L/R speaker connections.	15
E02:No Sur. SP	A surround channel signal is not detected.	Check the surround speaker connections.	15
E03:No PRNS SP	A presence channel signal is not detected.	Check the presence speaker connections.	15
E04:SBR→SBL	Only right surround back channel signal is detected.	Connect the surround back speaker to the SURROUND BACK SINGLE terminal if you only have one surround back speaker.	15
E05:Noisy	Background noise is too loud.	Try running “Auto Setup” in a quiet environment.	—
		Turn off noisy electric equipment like air conditioners or move them away from the optimizer microphone.	—
E06:Check Sur.	Surround back speakers are connected, though surround L/R speakers are not.	Connect surround speakers when you use surround back speakers.	15
E07:No MIC	The optimizer microphone was unplugged during the “Auto Setup” procedure.	Connect the supplied optimizer microphone to the OPTIMIZER MIC jack on the front panel.	37
E08:No Signal	The optimizer microphone does not detect test tones.	Check the microphone setting.	37
		Check the speaker connections and placement.	15
E09:User Cancel	The “Auto Setup” procedure was cancelled due to user activity.	Run “Auto Setup” again.	37
E10:Internal Err.	An internal error occurred.	Run “Auto Setup” again.	37

After Auto Setup

Warning message	Cause	Remedy	See page
W1:Out of Phase	Speaker polarity is not correct. This message may appear depending on the speakers even when the speakers are connected correctly.	Check the speaker connections for proper polarity (+ or –).	15
W2:Over Distance	The distance between the speaker and the listening position is over 24 m (80 ft).	Bring the speaker closer to the listening position.	—
W3:Level Error	The difference of volume level among speakers is excessive.	Readjust the speaker installation so that all speakers are set in locations with similar conditions.	—
		Check the speaker connections.	15
		Use speakers of similar quality.	—
		Adjust the output volume of the subwoofer.	37
W4:SP Mismatch	The result of the wiring check of “Auto Setup” is different from “Speaker Set” in “Manual Setup”.	Use “Speaker Set” in “Manual Setup” to adjust the speaker settings manually.	91

Notes

- If the “ERROR” or “WARNING” screens appears, check the cause of the problem, then run “Auto Setup” again.
- If warning “W2” or “W3” appears, the adjustment are made, however the adjustments may not be optimal.
- Depending on the speakers, warning “W1” may appears even if the speakers connections are correct.
- If error “E10” occurs repeatedly, please contact a qualified Yamaha service center.

Resetting the system

Use this feature to reset all the parameters of this unit to the initial factory settings.

Notes

- This procedure completely resets all the parameters of this unit including the “SET MENU” parameters. However, the advanced setup menu parameters will not be initialized.
- The initial factory settings are activated next time you turn on this unit.



To cancel the initialization procedure at any time without making any changes, press **Ⓐ MASTER ON/OFF** on the front panel to release it outward to the OFF position.

1 Press **Ⓐ MASTER ON/OFF** on the front panel to release it outward to the OFF position to turn off this unit.

2 Press and hold **Ⓟ STRAIGHT** and then press **Ⓐ MASTER ON/OFF** inward to the ON position to turn on this unit.

This unit turns on, and “ADVANCED SETUP” appears in the front panel display.



3 Rotate the **Ⓞ PROGRAM** selector to select “INITIALIZE”.

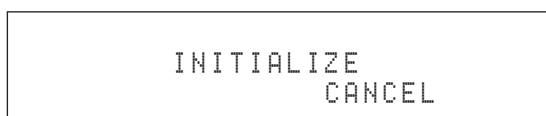

4 Press **Ⓟ STRAIGHT** repeatedly to select “ALL”.



- Select “CANCEL” to cancel the initialization procedure without making any changes.
- You can initialize the video parameters or sound field program parameters separately. See page 126 for details.

5 Press **Ⓐ MASTER ON/OFF** to release it outward to the OFF position to confirm your selection and turn off this unit.

Glossary

■ Audio and video synchronization (lip sync)

Lip sync, an abbreviation for lip synchronization, is a technical term that involves both a problem and a capability of maintaining audio and video signals synchronized during post-production and transmission. Whereas the audio and video latency requires complex end-user adjustments, HDMI version 1.3 incorporates an automatic audio and video syncing capability that allows devices to perform this synchronization automatically and accurately without user interaction.

■ Bi-amplification connection

A bi-amplification connection uses two amplifiers for a speaker. One amplifier is connected to the woofer section of a loudspeaker while the other is connected to the combined mid and tweeter section. With this arrangement each amplifier operates over a restricted frequency range. This restricted range presents each amplifier with a much simpler job and each amplifier is less likely to influence the sound in some way. The internal crossover of the speaker consists of a LPF (low pass filter) and a HPF (high pass filter). As its name implies, the LPF passes frequencies below a cutoff and rejects frequencies above the cutoff frequency. Likewise, the HPF passes frequencies above its cutoff.

■ Component video signal

With the component video signal system, the video signal is separated into the Y signal for the luminance and the P_B and P_R signals for the chrominance. Color can be reproduced more faithfully with this system because each of these signals is independent. The component signal is also called the “color difference signal” because the luminance signal is subtracted from the color signal. A monitor with component input jacks is required in order to output component signals.

■ Composite video signal

With the composite video signal system, the video signal is composed of three basic elements of a video picture: color, brightness and synchronization data. A composite video jack on a video component transmits these three elements combined.

■ Deep Color

Deep Color refers to the use of various color depths in displays, up from the 24-bit depths in previous versions of the HDMI specification. This extra bit depth allows HDTVs and other displays go from millions of colors to billions of colors and eliminate on-screen color banding for smooth tonal transitions and subtle gradations between colors. The increased contrast ratio can represent many times more shades of gray between black and white. Also Deep Color increases the number of available colors within the boundaries defined by the RGB or YCbCr color space.

■ Dialogue normalization

Dialogue Normalization is a feature of Dolby Digital or DTS, which is used to keep the programs at the same average listening level so that the user does not have to change the volume control between Dolby Digital or DTS programs.

■ Dolby Digital

Dolby Digital is a digital surround sound system that gives you completely independent multi-channel audio. With 3 front channels (front L/R and center), and 2 surround stereo channels, Dolby Digital provides 5 full-range audio channels. With an additional channel especially for bass effects, called LFE (Low Frequency Effect), the system has a total of 5.1-channels (LFE is counted as 0.1 channel). By using 2-channel stereo for the surround speakers, more accurate moving sound effects and surround sound environment are possible than with Dolby Surround. The wide dynamic range from maximum to minimum volume reproduced by the 5 full-range channels and the precise sound orientation generated using digital sound processing provide listeners with unprecedented excitement and realism. With this unit, any sound environment from monaural up to a 5.1-channel configuration can be freely selected for your enjoyment.

■ Dolby Digital EX

Dolby Digital EX creates 6 full-bandwidth output channels from 5.1-channel sources. This is done using a matrix decoder that derives 3 surround channels from the 2 in the original recording. For the best results, Dolby Digital EX should be used with movie sound tracks recorded with Dolby Digital Surround EX. With this additional channel, you can experience more dynamic and realistic moving sound especially with scenes with “fly-over” and “fly-around” effects.

■ Dolby Digital Plus

Dolby Digital Plus is an advanced audio technology developed for high-definition programming and media including HD broadcasts, HD DVD, and Blu-ray Disc. Selected as a mandatory audio standard for HD DVD and as an optional audio standard for Blu-ray Disc, this technology delivers multichannel sound with discrete channel output. Supporting bitrates up to 6.0 Mbps, Dolby Digital Plus can carry up to 7.1 discrete audio channels simultaneously. Supported by HDMI version 1.3 and designed for the optical disc players and AV receivers/amplifiers of the future, Dolby Digital Plus also remains fully compatible with the existing multichannel audio systems that incorporate Dolby Digital.

■ Dolby Pro Logic II

Dolby Pro Logic II is an improved technique used to decode vast numbers of existing Dolby Surround sources. This new technology enables a discrete 5-channel playback with 2 front left and right channels, 1 center channel, and 2 surround left and right channels instead of only 1 surround channel for conventional Pro Logic technology. There are three modes available: “Music mode” for music sources, “Movie mode” for movie sources and “Game mode” for game sources.

■ Dolby Pro Logic IIx

Dolby Pro Logic IIx is a new technology enabling discrete multi-channel playback from 2-channel or multi-channel sources. There are three modes available: “Music mode” for music sources, “Movie mode” for movie sources (for 2-channel sources only) and “Game mode” for game sources.

■ Dolby Surround

Dolby Surround uses a 4-channel analog recording system to reproduce realistic and dynamic sound effects: 2 front left and right channels (stereo), a center channel for dialog (monaural), and a surround channel for special sound effects (monaural). The surround channel reproduces sound within a narrow frequency range. Dolby Surround is widely used with nearly all video tapes and laser discs, and in many TV and cable broadcasts as well. The Dolby Pro Logic decoder built into this unit employs a digital signal processing system that automatically stabilizes the volume on each channel to enhance moving sound effects and directionality.

■ Dolby TrueHD

Dolby TrueHD is an advanced lossless audio technology developed for high-definition disc-based media including HD DVD and Blu-ray Disc. Selected as a mandatory audio standard for HD DVD and as an optional audio standard for Blu-ray Disc, this technology delivers sound that is bit-for-bit identical to the studio master, offering a high-definition home theater experience. Supporting bitrates up to 18.0 Mbps, Dolby TrueHD can carry up to 8 discrete channels of 24-bit/96 kHz audio simultaneously. Supported by HDMI version 1.3 and designed for the optical disc players and AV receivers/amplifiers of the future, Dolby TrueHD also remains fully compatible with the existing multichannel audio systems and retains the metadata capability of Dolby Digital, allowing dialog normalization and dynamic range control.

■ DSD

Direct Stream Digital (DSD) technology stores audio signals on digital storage media, such as Super Audio CDs. Using DSD, signals are stored as single bit values at a high-frequency sampling rate of 2.8224 MHz, while noise shaping and oversampling are used to reduce distortion, a common occurrence with very high quantization of audio signals. Due to the high sampling rate, better audio quality can be achieved than that offered by the PCM format used for normal audio CDs.

■ DTS 96/24

DTS 96/24 offers an unprecedented level of audio quality for multi-channel sound on DVD video, and is fully backward-compatible with all DTS decoders. “96” refers to a 96 kHz sampling rate compared to the typical 48 kHz sampling rate. “24” refers to 24-bit word length. DTS 96/24 offers sound quality transparent to the original 96/24 master, and 96/24 5.1-channel sound with full-quality full-motion video for music programs and motion picture soundtracks on DVD video.

■ DTS Digital Surround

DTS digital surround was developed to replace the analog soundtracks of movies with a 6.1-channel digital sound track, and is now rapidly gaining popularity in movie theaters around the world. DTS, Inc. has developed a home theater system so that you can enjoy the depth of sound and natural spatial representation of DTS digital surround in your home. This system produces practically distortion-free 6-channel sound (technically, front left and right, center, surround left and right, and LFE 0.1 (subwoofer) channels for a total of 5.1 channels). This unit incorporates a DTS-ES decoder that enables 6.1-channel reproduction by adding the surround back channel to the existing 5.1-channel format.

■ DTS Express

DTS Express is an advanced audio technology for the optional feature on Blu-ray Disc or HD DVD, which offers high-quality, low bit rate audio optimized for network streaming, and Internet applications. DTS Express is used for the Secondary Audio feature of Blu-ray Disc or the Sub Audio feature of HD DVD. These features deliver audio commentaries (for example, the additional commentaries made by the director of a film) on demand by the users via the Internet, etc. DTS Express signals are mixed down with the main audio stream on the player component, and the component sends the mixed audio stream to the AV receivers/amplifiers via digital coaxial, digital optical, or analog connections.

■ DTS-HD Master Audio

DTS-HD Master Audio is an advanced lossless audio technology developed for high-definition disc-based media including HD DVD and Blu-ray Disc. Selected as a mandatory audio standard for both HD DVD and Blu-ray Disc, this technology delivers sound that is bit-for-bit identical to the studio master, offering a high-definition home theater experience. Supporting bitrates up to 18.0 Mbps for HD DVD and up to 24.5 Mbps for Blu-ray Disc, DTS-HD Master Audio can carry up to 7.1 discrete channels of 24-bit/96 kHz audio simultaneously. Supported by HDMI version 1.3 and designed for the optical disc players and AV receivers/amplifiers of the future, DTS-HD Master Audio also remains fully compatible with the existing multichannel audio systems that incorporate DTS Digital Surround.

■ DTS-HD High Resolution Audio

DTS-HD High Resolution Audio is an high resolution audio technology developed for high-definition disc-based media including HD DVD and Blu-ray Disc. Selected as an optional audio standard for both HD DVD and Blu-ray Disc, this technology delivers sound that is virtually indistinguishable from the original, offering a high-definition home theater experience. Supporting bitrates up to 3.0 Mbps for HD DVD and 6.0 Mbps for Blu-ray Disc, DTS-HD High Resolution Audio can carry up to 7.1 discrete channels of 24-bit/96 kHz audio simultaneously. Supported by HDMI version 1.3 and designed for the optical disc players and AV receivers/amplifiers of the future, DTS-HD High Resolution Audio also remains fully compatible with the existing multichannel audio systems that incorporate DTS Digital Surround.

■ HDMI

HDMI (High-Definition Multimedia Interface) is the first industry-supported, uncompressed, all-digital audio/video interface. Providing an interface between any source (such as a set-top box or AV receiver) and an audio/video monitor (such as a digital television), HDMI supports standard, enhanced or high-definition video as well as multi-channel digital audio using a single cable. HDMI transmits all ATSC HDTV standards and supports 8-channel digital audio, with bandwidth to spare to accommodate future enhancements and requirements. When used in combination with HDCP (High-bandwidth Digital Content Protection), HDMI provides a secure audio/video interface that meets the security requirements of content providers and system operators. For further information on HDMI, visit the HDMI website at "<http://www.hdmi.org/>".

■ LFE 0.1 channel

This channel reproduces low-frequency signals. The frequency range of this channel is from 20 Hz to 120 Hz. This channel is counted as 0.1 because it only enforces a low-frequency range compared to the full-range reproduced by the other 5/6 channels in Dolby Digital or DTS 5.1/6.1-channel systems.

■ MP3

One of the audio compression methods used by MPEG. It employs the irreversible compression method, which achieves a high compression rate by thinning out the data of hardly audible part to the human ears. It is said to be capable of compressing the data quantity by about 1/11 (128 kbps) while maintaining a similar audio quality to music CD.

■ Neo:6

Neo:6 decodes the conventional 2-channel sources for 6-channel playback by the specific decoder. It enables playback with the full-range channels with higher separation just like digital discrete signal playback. There are two modes available: "Music mode" for music sources and "Cinema mode" for movie sources.

■ Neural-THX Surround

“Neural-THX®” Surround is taking surround sound to the next level. This revolutionary new technology delivers the rich envelopment and discrete image detail of surround sound in a format that is fully compatible with stereo. Neural-THX Surround reduces the bandwidth needed for broadcasters to deliver true, multi-channel surround presentations, and enables 7.1-channel support for gaming and movies. By unmasking the audio details, typically lost by other playback systems, audiences will experience the deep ambience and subtle details of movies, music and games. And with this technology being used by sound designers during content creation, as well as embedded into playback devices, Neural-THX Surround promises a listening experience that is true to the original mix. Neural-THX Surround has been chosen as the official surround sound broadcast format for XM Satellite Radio’s “XM HD Surround”, as well as other leading FM/HD radio stations worldwide. For additional information, please visit <http://www.neuralsurround.com/>.

■ PCM (Linear PCM)

Linear PCM is a signal format under which an analog audio signal is digitized, recorded and transmitted without using any compression. This is used as a method of recording CDs and DVD audio. The PCM system uses a technique for sampling the size of the analog signal per very small unit of time. Standing for “Pulse Code Modulation”, the analog signal is encoded as pulses and then modulated for recording.

■ Sampling frequency and number of quantized bits

When digitizing an analog audio signal, the number of times the signal is sampled per second is called the sampling frequency, while the degree of fineness when converting the sound level into a numeric value is called the number of quantized bits. The range of rates that can be played back is determined based on the sampling rate, while the dynamic range representing the sound level difference is determined by the number of quantized bits. In principle, the higher the sampling frequency, the wider the range of frequencies that can be played back, and the higher the number of quantized bits, the more finely the sound level can be reproduced.

■ S-video signal

With the S-video signal system, the video signal normally transmitted using a pin cable is separated and transmitted as the Y signal for the luminance and the C signal for the chrominance through the S-video cable. Using the S VIDEO jack eliminates video signal transmission loss and allows recording and playback of even more beautiful images.

■ WAV

Windows standard audio file format, which defines the method of recording the digital data obtained by converting audio signals. It does not specify the compression (coding) method so a desired compression method can be used with it. By default, it is compatible with the PCM method (no compression) and some compression methods including the ADPCM method.

■ WMA

An audio compression method developed by Microsoft Corporation. It employs the irreversible compression method, which achieves a high compression rate by thinning out the data of hardly audible part to the human ears. It is said to be capable of compressing the data quantity by about 1/22 (64 kbps) while maintaining a similar audio quality to music CD.

Sound field program information

■ Elements of a sound field

What really creates the rich, full tones of a live instrument are the multiple reflections from the walls of the room. In addition to making the sound live, these reflections enable us to tell where the player is situated as well as the size and shape of the room in which we are sitting.

There are two distinct types of sound reflections that combine to make up the sound field in addition to the direct sound coming straight to our ears from the player's instrument.

Early reflections

Reflected sounds reach our ears extremely rapidly (50 ms to 100 ms after the direct sound), after reflecting from one surface only (for example, from a wall or the ceiling).

Early reflections actually add clarity to the direct sound.

Reverberations

These are caused by reflections from more than one surface (for example, from the walls, and the ceiling) so numerous that they merge together to form a continuous sonic afterglow. They are non-directional and lessen the clarity of the direct sound.

Direct sound, early reflections and subsequent reverberations taken together help us to determine the subjective size and shape of the room, and it is this information that the digital sound field processor reproduces in order to create sound fields.

If you could create the appropriate early reflections and subsequent reverberations in your listening room, you would be able to create your own listening environment. The acoustics in your room could be changed to those of a concert hall, a dance floor, or a room with virtually any size at all. This ability to create sound fields at will is exactly what Yamaha has done with the digital sound field processor.

■ CINEMA DSP

Since the Dolby Surround and DTS systems were originally designed for use in movie theaters, their effect is best felt in a theater having many speakers designed for acoustic effects. Since home conditions, such as room size, wall material, number of speakers, and so on, can differ so widely, it is inevitable that there are differences in the sound heard. Based on a wealth of actually measured data, Yamaha CINEMA DSP provides the audiovisual experience of a movie theater in the listening room of your own home by using the Yamaha original sound field technology combined with various digital audio systems.

■ CINEMA DSP 3D

The actually measured sound field data contain the information of the height of the sound images. CINEMA DSP 3D feature achieves the reproduction of the accurate height of the sound images so that it creates the accurate and intensive stereoscopic sound fields in a listening room.

■ SILENT CINEMA

Yamaha has developed a natural, realistic sound effect DSP algorithm for headphones. Parameters for headphones have been set for each sound field so that accurate representations of all the sound field programs can be enjoyed on headphones.

■ Virtual CINEMA DSP

Yamaha has developed a Virtual CINEMA DSP algorithm that allows you to enjoy DSP sound field surround effects even without any surround speakers by using virtual surround speakers. It is even possible to enjoy Virtual CINEMA DSP using a minimal two-speaker system that does not include a center speaker.

■ Compressed Music Enhancer

The Compressed Music Enhancer feature of this unit enhances your listening experience by regenerating the missing harmonics in a compression artifact. As a result, flattened complexity due to the loss of high-frequency fidelity as well as lack of bass due to the loss of low-frequency bass is compensated, providing improved performance of the overall sound system.

■ Sound output from each speaker

Sound output from each speaker depends on the type of audio signals being input. Refer to the diagrams in the table below to understand the speaker layout for each sound field program. For details about the sound output from each speaker in sound field programs, refer to "Sound output in each sound field program" in "APPENDIX" at the end of this manual.

Note

Be advised that there may be no or not enough sound output from speakers depending on the type of input source being played back. Furthermore, there may be some channels that can only be used partially when they are adjusted to specific aspects of movies, such as special sound effects, etc.



Except for "2ch Stereo", "7ch Stereo", and "STRAIGHT", you can select a decoder to output sound from the surround back speakers (see page 45).

Parametric equalizer information

This unit employs Yamaha Parametric Room Acoustic Optimizer (YPAO) technology, together with the Parametric EQ settings (see page 85), to optimize the frequency characteristics of its parametric equalizer to match your listening environment. YPAO uses a combination of the following three parameters (Frequency, Gain and Q factor) to provide highly precise adjustment of the frequency characteristics.

■ Frequency

This parameter is adjustable in one-third octave increments between 32 Hz and 16 kHz.

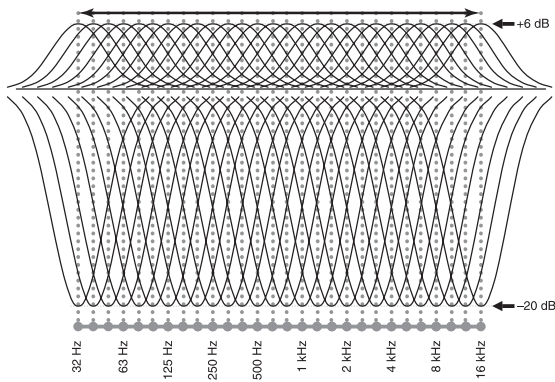

■ Gain

This parameter is adjustable in increments of 0.5 dB between -20 and +6 dB.

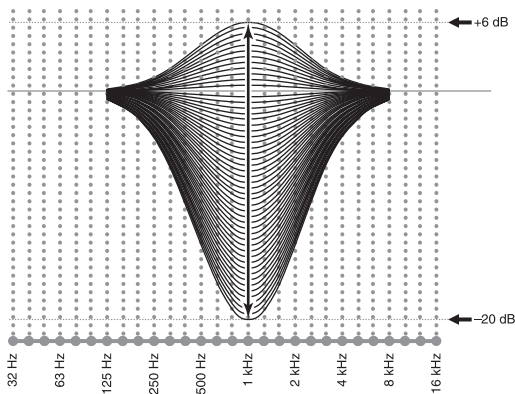

■ Q factor

The width of the specified frequency band is referred to as the Q factor. This parameter is adjustable between the values 0.5 and 10.

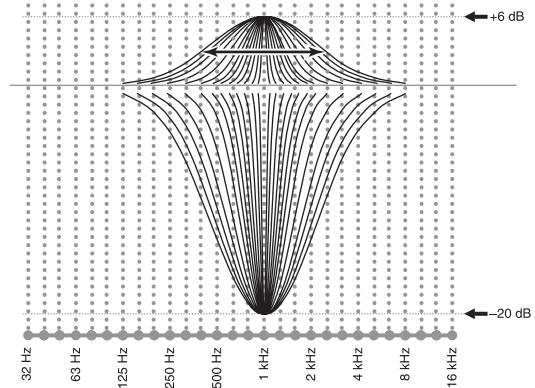

YPAO adjusts frequency characteristics to suit your listening requirements using a combination of the above three parameters (Frequency, Gain and Q factor) for each equalizer band in this unit's parametric equalizer. This unit has 7 equalizer bands for each channel.

The use of multiple equalizer bands enables more precise adjustments of frequency characteristics (as in Figure 2). This is not possible using only a single equalizer band (as in Figure 1).

Figure 1

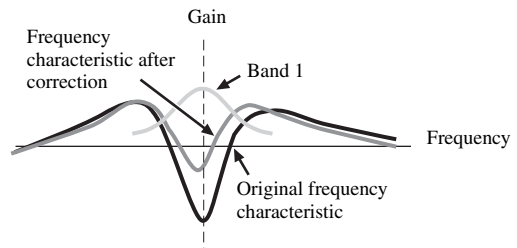
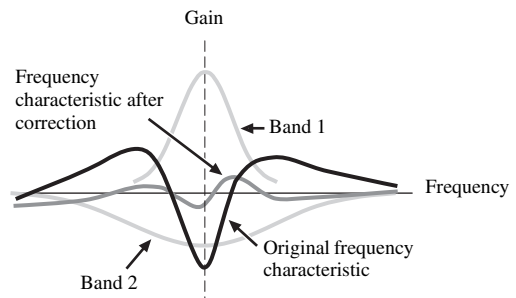

Figure 2



Specifications

AUDIO SECTION

- Minimum RMS Output Power for Front, Center, Surround, Surround back
20 Hz to 20 kHz, 0.04% THD, 8 Ω 140 W
- Dynamic Power (IHF)
Front L/R 8/6/4/2 Ω 170/205/265/345 W
- Maximum Useful Output Power (JEITA)
[Asia, General, China and Korea models]
1 kHz, 10% THD, 8 Ω 185 W
- Maximum Output Power [U.K. and Europe models]
1 kHz, 0.7% THD, 4 Ω 200 W
- Dynamic Headroom
8 Ω 0.84 dB
- IEC Output Power [U.K. and Europe models]
Front L/R 1 kHz, 0.04% THD, 8 Ω 145 W
- Damping Factor (IHF)
Front L/R 20 Hz to 20 kHz, 8 Ω 150 or more
- Input Sensitivity/Input Impedance
PHONO 3.5 mV/47 k Ω
CD, etc. 200 mV/47 k Ω
MULTI CH INPUT 200 mV/47 k Ω
- Maximum Input Voltage
PHONO (1 kHz, 0.1% THD) 60 mV or more
CD, etc. (1 kHz, 0.5% THD) 2.4 V or more
- Rated Output Voltage/Output Impedance
OUT (REC) 200 mV/900 Ω
PRE OUT 1.0 V/1.2 k Ω
SUBWOOFER 2.0 V/1.2 k Ω
ZONE 2/ZONE 3 OUT 1.0 V/1.4 k Ω
- Headphone Jack Rated Output/Impedance
CD, etc. (1 kHz, 40 mV, 8 Ω) 150 mV/100 Ω
- Frequency Response
CD to Front L/R, Pure Direct 10 Hz to 100 kHz, +0/-3 dB
- RIAA Equalization Deviation
PHONO (20 Hz to 20 kHz) 0 \pm 0.5 dB
- Total Harmonic Distortion
PHONO to OUT (REC)
(20 Hz to 20 kHz, 1 V) 0.02% or less
CD, etc. to Front L/R
(20 Hz to 20 kHz, 70 W, 8 Ω) 0.04% or less
- Signal to Noise Ratio (IHF-A Network)
PHONO (5 mV) to Front L/R
[Australia, U.K. and Europe models] 81 dB or more
[Other models] 86 dB or more
CD, etc. (250 mV) to Front L/R 100 dB or more
- Residual Noise (IHF-A Network)
Front L/R 150 μ V or less
- Channel Separation (1 kHz/10 kHz)
PHONO (shortened) to Front L/R 60 dB/55 dB or more
CD, etc. (5.1 k Ω shortened) to Front L/R ... 60 dB/45 dB or more

- Tone Control (Front L/R, Center, Subwoofer)
BASS Boost/Cut \pm 6 dB/50 Hz
BASS Turnover Frequency 350 Hz
TREBLE Boost/Cut \pm 6 dB/20 kHz
TREBLE Turnover Frequency 3.5 kHz
- Zone 2/Zone 3 Tone Control
BASS Boost/Cut \pm 10 dB/100 Hz
BASS Turnover Frequency 450 Hz
TREBLE Boost/Cut \pm 10 dB/10 kHz
TREBLE Turnover Frequency 2.0 kHz
- Filter Characteristics ($f_c=40/60/80/90/100/110/120/160/200$ Hz)
H.P.F. (Front, Center, Surround, Surround Back, Presence: Small)
..... 12 dB/oct.
L.P.F. (Subwoofer) 24 dB/oct.

VIDEO SECTION

- Video Format [MONITOR OUT] (Wall Paper)
[U.S.A., Canada, General and Korea models] NTSC/PAL
[U.K., Europe, Australia, Asia and China models]
..... PAL/NTSC
- Video Format (Video Conversion)
..... NTSC/PAL
- Signal Level
Composite 1 V_{p-p}/75 Ω
S-video 1 V_{p-p}/75 Ω (Y), 0.286 V_{p-p}/75 Ω (C)
Component 1 V_{p-p}/75 Ω (Y), 0.7 V_{p-p}/75 Ω (P_B/P_R)
- Maximum Input Level (Video Conversion Off)
..... 1.5 V_{p-p} or more
- Signal to Noise Ratio (Video Conversion Off)
..... 60 dB or more
- Frequency Response [MONITOR OUT]
Component (Video Conversion Off)
..... 5 Hz to 100 MHz, \pm 3 dB
- Video Format [ZONE OUT] (Gray Back)
[U.S.A., Canada, General and Korea models] NTSC
[U.K., Europe, Australia, Asia and China models] PAL

FM SECTION

- Tuning Range
[U.S.A. and Canada models] 87.5 to 107.9 MHz
[Asia and General models] 87.5/87.50 to 108.0/108.00 MHz
[Other models] 87.50 to 108.00 MHz
- 50 dB Quieting Sensitivity (IHF)
Mono/Stereo 2.0/25 μ V (17.3/39.2 dBf)
- Usable Sensitivity (IHF) 1.0 μ V (11.2 dBf)
- Selectivity (400 kHz) 70 dB
- Signal to Noise Ratio (IHF)
Mono/Stereo 76 dB/70 dB
- Harmonic Distortion (1 kHz)
Mono/Stereo 0.2/0.3%
- Stereo Separation (1 kHz)
Stereo 42 dB
- Frequency Response
Stereo 20 Hz to 15 kHz, +0.5, -2 dB
- Antenna Input (unbalanced) 75 Ω

AM SECTION

- Tuning Range
 - [U.S.A. and Canada models] 530 to 1710 kHz
 - [Asia and General models] 530/531 to 1710/1611 kHz
 - [Other models] 531 to 1611 kHz
- Usable Sensitivity 300 μ V/m

GENERAL

- Power Supply
 - [U.S.A. and Canada models] AC 120 V, 60 Hz
 - [General and Asia models] AC 110/120/220/230–240 V, 50/60 Hz
 - [China model] AC 220 V, 50 Hz
 - [Korea model] AC 220 V, 60 Hz
 - [Australia model] AC 240 V, 50 Hz
 - [U.K. and Europe models] AC 230 V, 50 Hz
- Power Consumption
 - [U.S.A. and Canada models] 500 W/630 VA
 - [Other models] 500 W
- Standby Power Consumption
 - [U.S.A. and Canada models] 0.1 W or less
 - [General model] (AC 240 V, 50 Hz) 0.33 W or less
 - [Other models] 0.1 W or less
- Maximum Power Consumption [General model only]
 - 6ch, 10% THD 1100 W
- AC Outlets
 - [U.S.A. and Canada models] 2 (Total 100 W/0.8 A maximum)
 - [Asia, General and China models] 2 (Total 50 W maximum)
 - [Australia model] 1 (100 W maximum)
 - [U.K. model] 1 (100 W/0.4 A maximum)
 - [Europe model] 2 (Total 100 W/0.4 A maximum)
- Dimensions (W x H x D) 435 x 171 x 438.5 mm
(17-1/8 x 6-3/4 x 17-1/4 in)
- Weight 17.4 kg (38 lbs 6 oz)

* Specifications are subject to change without notice.

■ HDMI signal compatibility

Audio signals

Audio signal types	Audio signal formats	Compatible media
2ch Linear PCM	2ch, 32-192 kHz, 16/20/24 bit	CD, DVD-Video, DVD-Audio, etc.
Multi-ch Linear PCM	8ch, 32-192 kHz, 16/20/24 bit	DVD-Audio, etc.
DSD	2/5.1ch, 2.8224 MHz, 1 bit	SACD, etc.
Bitstream	Dolby Digital, DTS	DVD-Video, etc.
Bitstream (High definition audio)	Dolby TrueHD, Dolby Digital Plus, DTS-HD Master Audio, DTS-HD High Resolution Audio	Blu-ray Disc, HD DVD, etc.



- If the input source component can decode the bitstream audio signals of audio commentaries, you can play back the audio sources with the audio commentaries mixed down by using the following connections:
 - multi-channel analog audio input (see page 29)
 - DIGITAL INPUT OPTICAL (or COAXIAL)
- Refer to the supplied instruction manuals of the input source component, and set the component appropriately.

Notes

- When CPPM copy-protected DVD audio is played back, video and audio signals may not be output depending on the type of the DVD player.
- This unit is not compatible with HDCP-incompatible HDMI or DVI components.
- To decode audio bitstream signals on this unit, set the input source component appropriately so that the component outputs the bitstream audio signals directly (does not decode the bitstream signals on the component). Refer to the supplied instruction manuals for details.
- This unit is not compatible with the audio commentary features (for example, the special audio contents downloaded via Internet) of Blu-ray Disc or HD DVD. This unit does not play back the audio commentaries of the Blu-ray Disc or HD DVD contents.

Video signals

This unit is compatible with the video signals of the following resolutions:

Video signal format

- 480i/576i
- 480p/576p
- 720p
- 1080i
- 1080p

Refresh rate

- 59.94(60)/50 Hz



This unit also accepts 30 or 36-bit Deep Color video signals.

The HDMI interface of this unit is based on the following standards:

- HDMI Version 1.3a (High-Definition Multimedia Interface Specification Version 1.3a) licensed by HDMI Licensing, LLC.
- HDCP (High-bandwidth Digital Content Protection System) licensed by Digital Content Protection, LLC.

Index

■ Numerics

- 2ch Stereo Direct,
 - Sound field parameter 79
- 2ch STEREO, Sound field programs 49
- 2-channel stereo direct,
 - Sound field parameter 79
- 3D indicator 36
- 7ch Enhancer Level,
 - Sound field parameter 79
- 7ch Enhancer, Sound field program 49
- 7ch Stereo Center Level,
 - Sound field parameter 79
- 7ch Stereo Presence L Level,
 - Sound field parameter 79
- 7ch Stereo Presence R Level,
 - Sound field parameter 79
- 7ch Stereo Sur. Back Level,
 - Sound field parameter 79
- 7ch Stereo Surround L Level,
 - Sound field parameter 79
- 7ch Stereo Surround R Level,
 - Sound field parameter 79
- 7ch STEREO, Sound field programs 49
- 7-channel Compressed Music Enhancer effect level, Sound field parameter 79
- 7-channel stereo center speaker level,
 - Sound field parameter 79
- 7-channel stereo presence left speaker level, Sound field parameter 79
- 7-channel stereo presence right speaker level, Sound field parameter 79
- 7-channel stereo surround back speaker level, Sound field parameter 79
- 7-channel stereo surround left speaker level, Sound field parameter 79
- 7-channel stereo surround right speaker level, Sound field parameter 79
- 96/24 indicator 35

■ A

- AC OUTLET(S) 32
- Action Game, Sound field programs 47
- Adaptive DRC, Volume 84
- Adaptive DSP effect level, Volume 84
- Adaptive DSP Lvl, Volume 84
- Adaptive dynamic range control,
 - Volume 84
- Advanced setup 122
- Advanced sound configurations 71
- Adventure, Sound field programs 49
- Albums, network menu 64
- ALL CH SEARCH 58
- All Channel Search mode, XM tuning 58
- AM antenna connection 32
- AM tuning 53
- AMP, Operation mode selector 34
- Antenna Level, Input select 81
- Antenna level, Input select 81
- Artists, network menu 64

- Audio and video synchronization,
 - Sound 87
- Audio cable plugs 20
- Audio components connection 27
- Audio Info., Input signal information 99
- Audio information, Input signal information 99
- Audio input jack select, Input menu 82
- Audio input jacks selection 42
- AUDIO jacks 20
- Audio jacks 20
- AUDIO SELECT 42
- Audio Select, Input menu 82
- Audio Select, Option 98
- Audio signal flow 22
- Auto Bypass, Tone control 87
- Auto bypass, Tone control 87
- AUTO indicator 36
- Auto Setup 37
- Auto,
 - Audio and video synchronization 87
- Automatic audio delay adjustment 87
- Automatic preset tuning,
 - FM/AM tuning 54
- Automatic tuning, FM/AM tuning 53

■ B

- Back ground video, Input select 83
- Basic, Manual Setup 91
- Basic, Manual setup 91
- Bass control, Tone control 86
- Bass Cross Over, Speaker settings 93
- Bass cross over, Speaker settings 93
- Bass Out, Speaker settings 92
- Bass out, Speaker settings 92
- Bass, Tone control 86
- Battery charge indicator 35
- BGV, Input select 83
- BI-AMP, Advanced setup 126
- Bi-AMP, Advanced setup 126
- Blu-ray Disc player connection 24
- Bookmarks, network menu 64

■ C

- Cable plugs 20
- CAT SEARCH, XM tuning 58
- CD player connection 27
- Cellar Club, Sound field programs 47
- CENTER PRE OUT jack connection 28
- Center speaker, Speaker settings 92
- Center, Speaker settings 92
- Chamber, Sound field programs 46
- Channel Mute, Sound 88
- Channel mute, Sound 88
- Church in Freiburg,
 - Sound field programs 46
- CINEMA DSP indicator 36
- CLASSICAL, Sound field programs 46
- Component I/P, Video 89

- Component interlace/progressive conversion, Video 89
- COMPONENT VIDEO jacks 20
- Compressed Music Enhancer 49
- Connection, AM antenna 32
- Connection, audio components 27
- Connection, Blu-ray Disc player 24
- Connection, CD player 27
- Connection, CENTER PRE OUT jack 28
- Connection, DVD player 25
- Connection, DVD recorder 26
- Connection, external decoder 29
- Connection, FM antenna 32
- Connection, FRONT PRE OUT jack 28
- Connection, iPod 30
- Connection, Multi-format player 29
- Connection, network 31
- Connection, Power cable 32
- Connection,
 - PRESENCE PRE OUT jack 28
- Connection, projector 23
- Connection, PVR 26
- Connection, set-top box 26
- Connection,
 - SUBWOOFER PRE OUT jack 28
- Connection, SURROUND BACK PRE OUT jack 28
- Connection,
 - SURROUND PRE OUT jack 28
- Connection, turntable 27
- Connection, TV monitor 23
- Connection, VCR 26
- Control, Tone control 86
- Conversion, Video 89

■ D

- Decoder descriptions 71
- Decoder indicators 36
- Decoder Mode, Input menu 82
- Decoder mode, Input menu 82
- Decoder Mode, Option 98
- Decoder parameter descriptions 80
- Decoder Type, Sound field parameter 76
- Decoder Type, Sound field parameter 76
- Default audio input jack select, Option 98
- Default decoder mode, Option 98
- Default extended surround setting,
 - Option 98
- Default Gateway, Network settings 94
- Default gateway, Network settings 94
- DHCP setting, Network settings 94
- DHCP, Network settings 94
- Dialogue Lift, Sound field parameter 75
- Dialogue lift, Sound field parameter 75
- DIGITAL COAXIAL jacks 20
- DIGITAL OPTICAL jacks 20
- Dimmer, Front panel display setting 96
- Dimmer, Front panel display setting 96
- Direct number access mode,
 - XM tuning 58

- Distance, Auto setup parameter 39, 40
 DNS Server (P), Network settings 94
 DNS Server (S), Network settings 94
 DOCK indicator 35
 Drama, Sound field programs 49
 DSP effect level,
 Sound field parameter 74
 DSP indicators 36
 DSP Level, Sound field parameter 74
 DTS Neo:6 Music center image,
 Decoder parameter 80
 DVD player connection 25
 DVD recorder connection 26
 Dynamic Range, Sound 85
 Dynamic range, Sound 85
- **E**
- Each speaker settings, Channel mute 88
 ENHANCER indicator 36
 ENTERTAINMENT,
 Sound field programs 47
 Equalizing, Auto setup parameter 39, 40
 EXTD Surround, Decoder parameter 80
 EXTD Surround, Option 98
 EXTD Surround, Sound 88
 Extended surround mode,
 Decoder parameter 80
 Extended surround, Sound 88
 External amplifier connection 28
 External decoder connection 29
- **F**
- Files/Directories, USB menu 64
 FM antenna connection 32
 FM tuning 53
 Front Input,
 Multi channel assignment 83
 Front left and right channels input jacks,
 Multi channel assignment 83
 Front Panel Disp., Option 96
 Front panel display message scroll,
 Front panel display setting 96
 Front panel display setting, Option 96
 Front panel door 34
 FRONT PRE OUT connection 28
 Front, Speaker settings, Front speakers,
 Speaker settings 92
- **G**
- Genres, network menu 64
 Graphic user interface (GUI) screen 73
 GUI LANGUAGE, Advanced setup 126
 GUI language, Advanced setup 126
 GUI screen position, Video 90
- **H**
- Hall in Amsterdam,
 Sound field programs 46
 Hall in Munich, Sound field programs 46
 Hall in Vienna, Sound field programs 46
 HDMI 21
 HDMI aspect ratio, Video 90
 HDMI Aspect, Video 90
- HDMI Auto, Audio and video
 synchronization 87
 HDMI automatic lip sync mode 87
 HDMI indicator 35
 HDMI monitor check,
 Advanced setup 126
 HDMI Resolution, Video 90
 HDMI Set, Option 98
 HDMI settings, Option 98
 HDMI video signal resolution, Video 90
 Headphone dynamic range 85
 Headphone low-frequency effect level 85
 Headphones 42
 Headphones indicator 36
 Headphones, dynamic range 85
 Headphones,
 Low frequency effect level 85
 Help, network menu 64
 HiFi DSP indicator 36
- **I**
- I/O Assignment, Input menu 82
 Information, NET/USB 95
 Infrared window 34
 Init. Delay, Sound field parameter 76
 Initial delay, Sound field parameter 76
 Initial Volume, Volume 84
 Initial volume, Volume 84
 INITIALIZE, Advanced setup 126
 Initialize, Sound field parameter 80
 Input channel and speaker indicators 35
 Input channel indicators 35
 Input Channels,
 Multi channel assignment 83
 Input channels,
 Multi channel assignment 83
 Input Select, GUI menu 81
 Input select, GUI menu 81
 Input signal indicators 36
 Input signal information, GUI menu 98
 Input source indicators 35
 Input/output assignment, Input menu 82
 Internet radio 67
 Internet Radio, network menu 64
 IP Address, Network settings 94
 IP address, Network settings 94
 iPod Charge on the standby mode,
 iPod settings 96
 iPod connection 30
 iPod settings, Option 96
 iPod use 62
 iPod, Option 96
- **J**
- Jacks 20
- **L**
- LAN connection 31
 Language, GUI menu 99
 Language, GUI menu 99
 Level, Auto setup parameter 39, 40
 LFE Level, Sound 85
 Lipsync, Sound 87
 LIVE/CLUB, Sound field programs 46
- Liveness, Sound field parameter 77
 Liveness, Sound field parameter 77
 Locations, network menu 64
 Low-frequency effect level, Sound 85
- **M**
- MAC Address, Network information 95
 MAC address, Network information 95
 Macro programming, remote control 111
 Manual audio delay adjustment 87
 Manual preset tuning, FM/AM tuning 54
 Manual tuning, FM/AM tuning 53
 Manual,
 Audio and video synchronization 87
 MASTER ON/OFF 33
 Max Volume, Volume 84
 Maximum volume, Volume 84
 Memory Guard, Option 98
 Memory guard, Option 98
 MEMORY indicator 36
 Mode, Channel mute 88
 Mode, Channel mute 88
 MONITOR CHECK,
 Advanced setup 126
 Mono Movie, Sound field programs 49
 MOVIE, Sound field programs 48
 Multi CH Assign, Input menu 83
 MULTI CH INPUT
 component selection 42
 MULTI CH INPUT jacks 29
 Multi channel assignment, Input menu 83
 Multi-format player connection 29
 Multi-channel source playback
 in 2-channel stereo 52
 Multi-channel sources playback
 with headphones 50
 Multi-information display 35
 MULTI-ZONE configuration,
 Zone2, Zone3 117
 MUSIC ENHANCER,
 Sound field category 49
 Music Video, Sound field programs 48
 MUTE 43
 MUTE indicator 35
 Muting 43
 Muting Type, Volume 84
 Muting type, Volume 84
- **N**
- Neo:6 Cinema, Decoder type 72
 Neo:6 Music Center Image,
 Decoder parameter 80
 Neo:6 Music, Decoder type 72
 NET/USB, Manual setup 94
 NET/USB, Manual setup 94
 Network connection 31
 Network feature 64
 Network information, NET/USB 95
 Network menu 64
 Network settings, NET/USB 94
 Network status, Network information 95
 Network, NET/USB 94
 neural indicator 36
 Neural THX, Decoder type 72

- New Stations, network menu 64
- **O**
- On Screen, Video 90
- On-screen display time, Video 90
- On-screen display, Option 96
- Operation mode selector 34
- OPTIMIZER MIC jack 37
- Optimizer microphone 37
- Option, Manual setup 96
- Option, Manual setup 96
- Other components controlling
by Remote control 106
- Other components controlling,
Remote control 106
- **P**
- Parameter initialization,
Advanced setup 126
- Parametric EQ, Sound 85
- Parametric equalizer information 143
- Parametric equalizer level,
Auto setup parameter 39, 40
- Parametric equalizer, Sound 85
- PC server 66
- PC/MusicCAST, network feature 64
- PHONES jack 42
- Play Style, NET/USB 95
- Playback basic procedure 41
- Playback styles, NET/USB 95
- Playlists, network menu 64
- PLII Game, Decoder type 71
- PLII Movie, Decoder type 71, 72
- PLII Music, Decoder type 71
- PLIIX Game, Decoder type 71
- PLIIX Movie, Decoder type 71, 72
- PLIIX Music and PLII Music Center
Width, Decoder parameter 80
- PLIIX Music and PLII Music Dimension,
Decoder parameter 80
- PLIIX Music, Decoder type 71
- Podcasts, network menu 64
- Popular Stations, network menu 64
- Position, Video 90
- Power cable connection 32
- PR/SB Priority, Speaker settings 93
- Presence and surround back speaker
indicators 35
- PRESENCE PRE OUT
jack connection 28
- Presence speakers, Speaker settings 92
- Presence, Speaker settings 92
- Presence/surround back speaker priority,
Speaker settings 93
- Preset channel setting, XM tuning 59
- Preset Search mode, XM tuning 58
- Preset stations exchange,
FM/AM tuning 55
- Preset stations selection 55
- Primary DNS server, Network settings 94
- Pro Logic IIX Music and Pro Logic II Music
center width, Decoder parameter 80
- Pro Logic IIX Music and Pro Logic II Music
Dimension, Decoder parameter 80
- PRO LOGIC, Decoder type 71
- Projector connection 23
- PURE DIRECT 51
- Pure hi-fi sound 51
- PVR connection 26
- **R**
- RC AMP ID, Advanced setup 123
- RC TUNER ID, Advanced setup 124
- RC XM ID, Advanced setup 125
- Recall Play, network menu 64
- Recital/Opera, Sound field programs 48
- RECOUT indicator 35
- Remote control AMP ID,
Advanced setup 123
- Remote control code default settings 107
- Remote control codes settings 107
- Remote control TUNER ID,
Advanced setup 124
- Remote control XM ID,
Advanced setup 125
- REMOTE IN jack 30
- REMOTE OUT jack 30
- REMOTE SENSOR, Advanced setup 122
- Remote sensor, Advanced setup 122
- Rename, Input menu 83
- Rename, Input menu 83
- Repeat 63
- Repeat iPod playback 63
- Repeat, Playback styles 95
- Repeat, Playback styles 95
- Resetting the system 137
- Rev. Delay, Sound field parameter 78
- Rev. Level, Sound field parameter 78
- Rev. Time, Sound field parameter 77
- Reverberation delay, Sound field
parameter 78
- Reverberation level,
Sound field parameter 78
- Reverberation time,
Sound field parameter 77
- Roleplaying Game,
Sound field programs 47
- Room Size, Sound field parameter 76
- Room size, Sound field parameter 76
- RS-232C STANDBY,
Advanced setup 123
- **S**
- S VIDEO jacks 20
- SB. Init. Delay,
Sound field parameter 76
- SB. Liveness, Sound field parameter 77
- SB. Room Size,
Sound field parameter 76
- Sci-Fi, Sound field programs 48
- Scroll, Front panel display setting 96
- Secondary DNS server,
Network settings 94
- Selection, Audio input jacks 42
- Selection, MULTI CH INPUT
component 42
- Server, network menu 64
- Set-top box connection 26
- Setup, Network settings 94
- Setup, Network settings 94
- Short message display, Video 90
- Short Message, Video 90
- Shortcut buttons,
Network/USB feature 68
- Shuffle 63
- Shuffle iPod playback 63
- Shuffle, Playback styles 95
- Shuffle, Playback styles 95
- Signal Info., GUI menu 98
- SILENT CINEMA 50
- SILENT CINEMA indicator 36
- Size, Auto setup parameter 39, 40
- SLEEP indicator 36
- Sleep timer 43
- Songs, network menu 64
- Sound field indicators 36
- Sound field parameter descriptions 76
- Sound field programs 45
- Sound field programs
with headphones 50
- Sound field programs
without surround speakers 50
- Sound, Manual Setup 85
- Sound, Manual setup 85
- SOURCE, Operation mode selector 34
- Speaker distance,
Auto setup parameter 39, 40
- Speaker Distance, Basic 93
- Speaker distance, Basic 93
- Speaker dynamic range 85
- SPEAKER IMP., Advanced setup 122
- Speaker impedance setting 33
- Speaker impedance, Advanced setup 122
- Speaker level adjusting 52
- Speaker Level, Basic 94
- Speaker level, Basic 94
- Speaker low-frequency effect level 85
- Speaker Set, Basic 91
- Speaker settings, Basic 91
- Speaker size,
Auto setup parameter 39, 40
- Speaker wiring,
Auto setup parameter 39, 40
- Speakers Dynamic range 85
- Speakers, Low-frequency effect level 85
- Specifications 144
- Spectacle, Sound field programs 48
- Sports, Sound field programs 47
- Standard, Sound field programs 48
- Standby Charge, iPod settings 96
- Standby mode, Zone2, Zone3 119
- Status, Network information 95
- STEREO indicator 36
- Stereo program parameter descriptions 79
- STEREO, Sound field programs 49
- Stereo/Surround menu, GUI menu 74
- Stereo/Surround, GUI menu 74
- STRAIGHT 50
- Straight Compressed Music Enhancer effect
level, Sound field parameter 79
- Straight Enhancer Level,
Sound field parameter 79

- Straight Enhancer,
Sound field program 49
- STRAIGHT mode 50
- Subnet Mask, Network settings 94
- Subnet mask, Network settings 94
- Subwoofer phase, Speaker settings 93
- SUBWOOFER PRE OUT
jack connection 28
- Supplied accessories 4
- Support Audio, HDMI settings 98
- Support audio, HDMI settings 98
- SUR. DECODE, Decoder category 71
- Sur. Init. Delay,
Sound field parameter 76
- Sur. Liveness, Sound field parameter 77
- Sur. Room Size,
Sound field parameter 76
- Surround back initial delay,
Sound field parameter 76
- Surround back left/right speakers,
Speaker settings 92
- Surround back liveness,
Sound field parameter 77
- SURROUND BACK PRE OUT
jack connection 28
- Surround back room size,
Sound field parameter 76
- Surround Back, Speaker settings 92
- Surround initial delay,
Sound field parameter 76
- Surround left/right speakers,
Speaker settings 92
- Surround liveness,
Sound field parameter 77
- SURROUND PRE OUT
jack connection 28
- Surround room size,
Sound field parameter 76
- Surround, Speaker settings 92
- SWFR Phase, Speaker settings 93
- System ID, Network information 95
- System Memory 100
- System memory 100
- System, Network information 95
- **T**
- Test Tone, Basic 91
- Test tone, Basic 91
- Test Tone, Parametric EQ 86
- Test tone, Parametric EQ 86
- The Bottom Line,
Sound field programs 47
- The Roxy Theatre,
Sound field programs 47
- Tonal quality adjusting 51
- Tone Control, Sound 86
- Tone control, Sound 86
- Tone control, Tone control 86
- TRANSMIT indicator 34
- Treble control, Tone control 87
- Treble, Tone control 87
- Troubleshooting 127
- TUNED indicator 36
- Tuner frequency step,
Advanced setup 126
- TUNER FRQ STEP, Advanced setup 126
- Tuner indicators 36
- Turning off 33
- Turning on 33
- Turntable connection 27
- TV controlling by Remote control 105
- TV controlling, Remote control 105
- TV FORMAT, Advanced setup 126
- TV format, Advanced setup 126
- TV monitor connection 23
- TV, Operation mode selector 34
- **U**
- Unit, Speaker distance 94
- Unit, Speaker distance 94
- Unprocessed input sources 50
- USB feature 64
- USB memory device 68
- USB menu 64
- USB portable audio player 68
- USB, USB menu 64
- **V**
- VCR connection 26
- VIDEO AUX jacks 30
- Video conversion, Video 89
- Video Info., Input signal information 99
- Video information, Input signal
information 99
- VIDEO jacks 20
- Video jacks 20
- Video Manual setup 89
- Video signal flow 22
- Video sources in the background 43
- Video, Manual setup 89
- Village Vanguard,
Sound field programs 46
- Virtual CINEMA DSP 50
- VIRTUAL indicator 36
- VOLTAGE SELECTOR 5
- VOLUME level indicator 35
- Volume level,
Auto setup parameter 39, 40
- Volume Manual setup 84
- Volume Trim, Input menu 82
- Volume trimming, Input menu 82
- Volume, Manual setup 84
- **W**
- Wake on RS-232C access,
Advanced setup 123
- Wall Paper, Video 91
- Wall paper, Video 91
- Warehouse Loft,
Sound field programs 46
- Wiring, Auto setup parameter 39, 40
- **X**
- XM Mini-Tuner Home Dock 56
- XM satellite radio activation 57
- XM Satellite Radio display 60
- XM satellite radio tuning 56
- **Y**
- Yamaha MCX-2000 66
- YPAO indicator 36
- **Z**
- Zone 2 amplifier, Zone 2 setting 97
- Zone 2 initial volume,
Zone 2 setting 97
- Zone 2 maximum volume,
Zone 2 setting 97
- Zone 2 setting, Option 97
- Zone 2 volume, Zone 2 setting 97
- Zone 3 amplifier, Zone 3 setting 97
- Zone 3 Initial volume, Zone 3 setting 97
- Zone 3 maximum volume,
Zone 3 setting 97
- Zone 3 setting, Option 97
- Zone 3 volume, Zone 3 setting 97
- Zone OSD, Option 96
- Zone2 Amplifier, Zone 2 setting 97
- Zone2 Initial Vol., Zone 2 setting 97
- Zone2 Max Vol., Zone 2 setting 97
- Zone2 Set, Option 97
- Zone2 Volume, Zone 2 setting 97
- ZONE2/ZONE3 indicators 36
- Zone3 Amplifier, Zone 3 setting 97
- Zone3 Initial Vol., Zone 3 setting 97
- Zone3 Max Vol., Zone 3 setting 97
- Zone3 Set, Option 97
- Zone3 Volume, Zone 3 setting 97

“**Ⓜ** MASTER ON/OFF” or
“**Ⓛ** DVD” (example) indicates the
name of the parts on the front panel
or the remote control. Refer to the
attached sheet or the pages at the
end of this manual for the
information about each position of
the parts.

■ Front panel

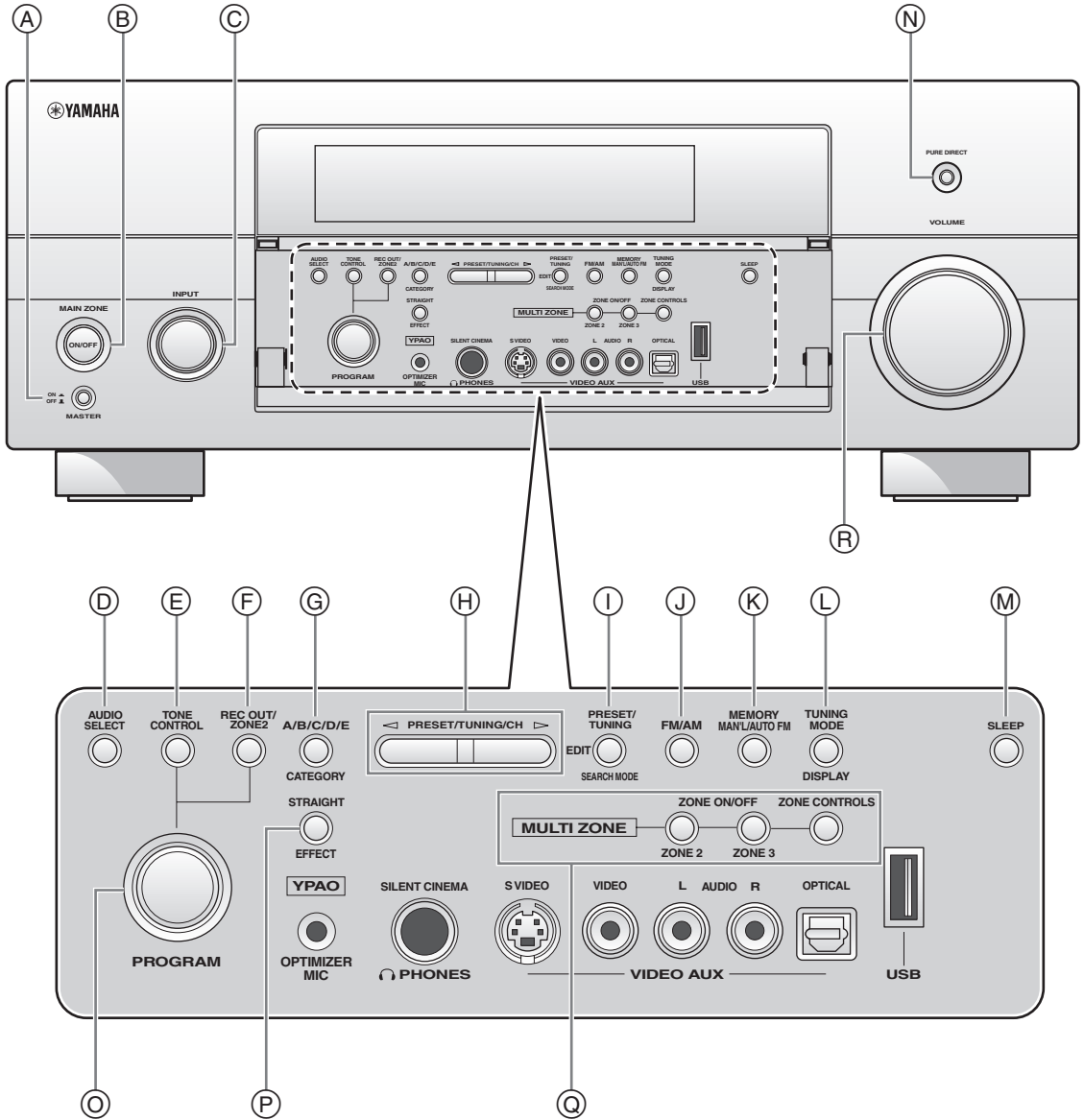

■ Remote control

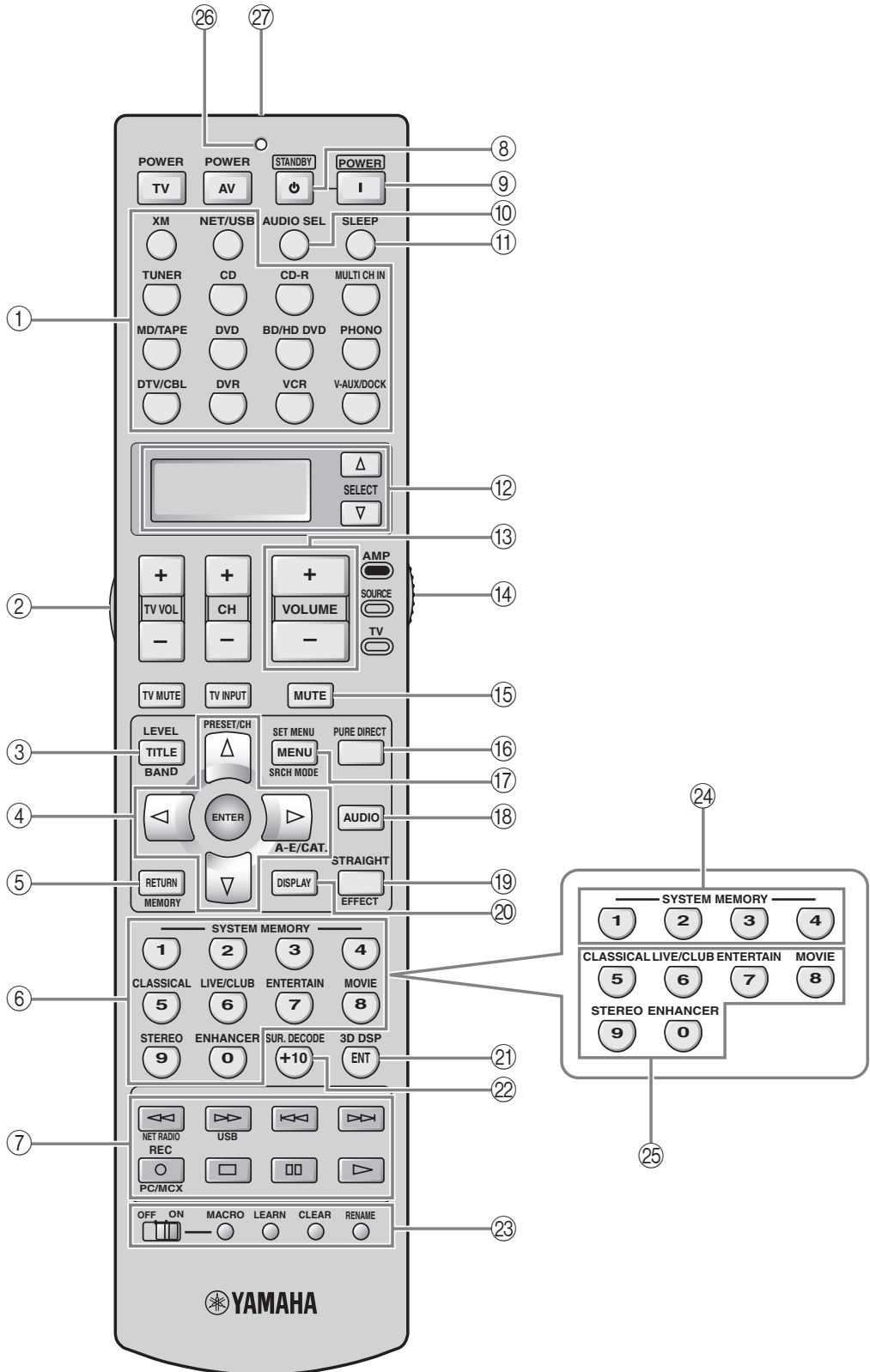

Sound output in each sound field program

- L Front left speaker
- C Center speaker
- R Front right speaker
- SL Surround left speaker
- SR Surround right speaker
- SBL Surround back left speaker
- SBR Surround back right speaker
- PL Presence left speaker
- PR Presence right speaker
- Speaker from which sound is being output
- Speaker from which no sound is being output

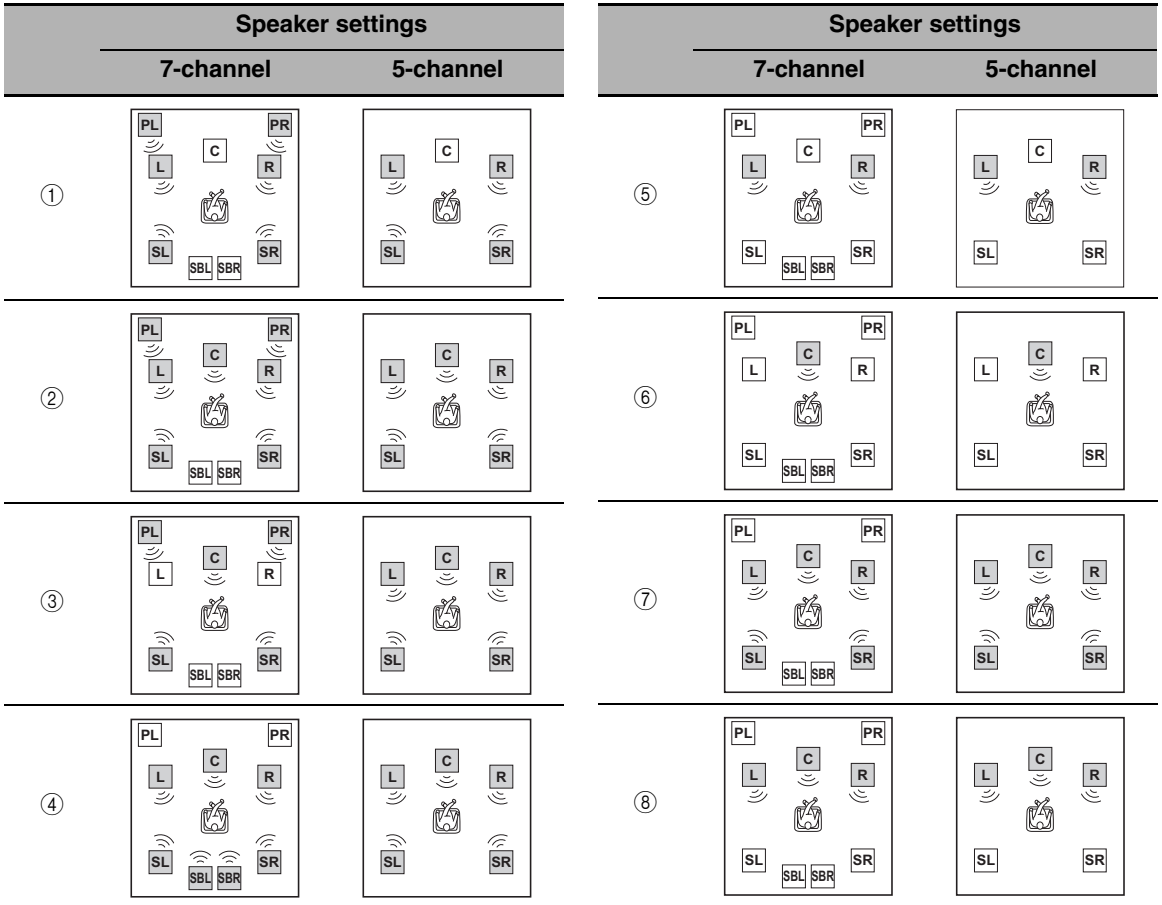

*1 DOLBY DIGITAL / DOLBY DIGITAL / **DTS** / **DTS** / (neural): OFF

*2 DOLBY DIGITAL / DOLBY DIGITAL / **DTS** / (neural): ON or discrete 6.1/7.1-channel audio signals are input.

Program	3D	PR/SB Priority	Input audio source			
			2-channel (monaural)	2-channel (stereo)	5.1-channel*1	6.1/7.1- channel*2
CLASSICAL Hall in Munich Hall in Vienna Hall in Amsterdam	ON	Presence/ Surround Back	①	①	②	②
	OFF	Presence	①	①	②	④
LIVE/CLUB Village Vanguard Warehouse Loft Cellar Club The Roxy Theatre The Bottom Line	OFF	Surround Back	①	①	②	④
		Presence	③	②	②	④
ENTERTAINMENT Sports Music Video Recital/Opera Action Game Roleplaying Game	ON	Presence/ Surround Back	②	②	②	②
	OFF	Surround Back	⑦	④	②	④
MOVIE STANDARD Spectacle Sci-Fi Adventure Drama	ON	Presence/ Surround Back	②	②	②	②
	OFF	Presence	③	②	②	④
MOVIE Mono Movie	ON	Presence/ Surround Back	②	②	②	②
	OFF	Surround Back	③	②	②	④
STEREO 2ch Stereo	--	Presence/ Surround Back	⑤	⑤	⑤	⑤
STEREO 7ch Stereo MUSIC ENHANCER 7ch Enhancer	--	Presence/ Surround Back	④	④	④	④
SUR.DECODE Surround Decoder (Pro Logic) (PLII Movie) (PLII Game)	--	Presence/ Surround Back	⑥	⑦	⑦	④
SUR.DECODE Surround Decoder (PLII Music)	--	Presence/ Surround Back	⑧	⑦	⑦	④
SUR.DECODE Surround Decoder (PLIIx Movie) (PLIIx Game) (Neo:6 Cinema) (Neural THX)	--	Presence/ Surround Back	⑥	④	⑦	④
SUR.DECODE Surround Decoder (PLIIx Music) (Neo:6 Music)	--	Presence/ Surround Back	⑧	④	⑦	④
STRAIGHT Pure Direct MUSIC ENHANCER Straight Enhancer	--	Presence/ Surround Back	⑤	⑤	⑦	④

GPL/LGPL

■ GNU GENERAL PUBLIC LICENSE

Version 2, June 1991

Copyright (C) 1989, 1991 Free Software Foundation, Inc. 59 Temple Place, Suite 330, Boston, MA 02111-1307 USA Everyone is permitted to copy and distribute verbatim copies of this license document, but changing it is not allowed.

Preamble

The licenses for most software are designed to take away your freedom to share and change it. By contrast, the GNU General Public License is intended to guarantee your freedom to share and change free software—to make sure the software is free for all its users. This General Public License applies to most of the Free Software Foundation's software and to any other program whose authors commit to using it. (Some other Free Software Foundation software is covered by the GNU Library General Public License instead.) You can apply it to your programs, too.

When we speak of free software, we are referring to freedom, not price. Our General Public Licenses are designed to make sure that you have the freedom to distribute copies of free software (and charge for this service if you wish), that you receive source code or can get it if you want it, that you can change the software or use pieces of it in new free programs; and that you know you can do these things.

To protect your rights, we need to make restrictions that forbid anyone to deny you these rights or to ask you to surrender the rights. These restrictions translate to certain responsibilities for you if you distribute copies of the software, or if you modify it.

For example, if you distribute copies of such a program, whether gratis or for a fee, you must give the recipients all the rights that you have. You must make sure that they, too, receive or can get the source code. And you must show them these terms so they know their rights.

We protect your rights with two steps: (1) copyright the software, and (2) offer you this license which gives you legal permission to copy, distribute and/or modify the software.

Also, for each author's protection and ours, we want to make certain that everyone understands that there is no warranty for this free software. If the software is modified by someone else and passed on, we want its recipients to know that what they have is not the original, so that any problems introduced by others will not reflect on the original authors' reputations.

Finally, any free program is threatened constantly by software patents. We wish to avoid the danger that redistributors of a free program will individually obtain patent licenses, in effect making the program proprietary. To prevent this, we have made it clear that any patent must be licensed for everyone's free use or not licensed at all.

The precise terms and conditions for copying, distribution and modification follow.

TERMS AND CONDITIONS FOR COPYING, DISTRIBUTION AND MODIFICATION

0. This License applies to any program or other work which contains a notice placed by the copyright holder saying it may be distributed under the terms of this General Public License. The "Program", below, refers to any such program or work, and a "work based on the Program" means either the Program or any derivative work under copyright law: that is to say, a work containing the Program or a portion of it, either verbatim or with modifications and/or translated into another language. (Hereinafter, translation is included without limitation in the term "modification".) Each licensee is addressed as "you".

Activities other than copying, distribution and modification are not covered by this License; they are outside its scope. The act of running the Program is not restricted, and the output from the Program is covered only if its contents constitute a work based on the Program (independent of having been made by running the Program). Whether that is true depends on what the Program does.

1. You may copy and distribute verbatim copies of the Program's source code as you receive it, in any medium, provided that you conspicuously and appropriately publish on each copy an appropriate copyright notice and disclaimer of warranty; keep intact all the notices that refer to this License and to the absence of any warranty; and give any other recipients of the Program a copy of this License along with the Program.

You may charge a fee for the physical act of transferring a copy, and you may at your option offer warranty protection in exchange for a fee.

2. You may modify your copy or copies of the Program or any portion of it, thus forming a work based on the Program, and copy and distribute such modifications or work under the terms of Section 1 above, provided that you also meet all of these conditions:
 - a) You must cause the modified files to carry prominent notices stating that you changed the files and the date of any change.
 - b) You must cause any work that you distribute or publish, that in whole or in part contains or is derived from the Program or any part thereof, to be licensed as a whole at no charge to all third parties under the terms of this License.
 - c) If the modified program normally reads commands interactively when run, you must cause it, when started running for such interactive use in the most ordinary way, to print or display an announcement including an appropriate copyright notice and a notice that there is no warranty (or else, saying that you provide a warranty) and that users may redistribute the program under

these conditions, and telling the user how to view a copy of this License. (Exception: if the Program itself is interactive but does not normally print such an announcement, your work based on the Program is not required to print an announcement.)

These requirements apply to the modified work as a whole. If identifiable sections of that work are not derived from the Program, and can be reasonably considered independent and separate works in themselves, then this License, and its terms, do not apply to those sections when you distribute them as separate works. But when you distribute the same sections as part of a whole which is a work based on the Program, the distribution of the whole must be on the terms of this License, whose permissions for other licensees extend to the entire whole, and thus to each and every part regardless of who wrote it.

Thus, it is not the intent of this section to claim rights or contest your rights to work written entirely by you; rather, the intent is to exercise the right to control the distribution of derivative or collective works based on the Program.

In addition, mere aggregation of another work not based on the Program with the Program (or with a work based on the Program) on a volume of a storage or distribution medium does not bring the other work under the scope of this License.

3. You may copy and distribute the Program (or a work based on it, under Section 2) in object code or executable form under the terms of Sections 1 and 2 above provided that you also do one of the following:
 - a) Accompany it with the complete corresponding machine-readable source code, which must be distributed under the terms of Sections 1 and 2 above on a medium customarily used for software interchange; or,
 - b) Accompany it with a written offer, valid for at least three years, to give any third party, for a charge no more than your cost of physically performing source distribution, a complete machine-readable copy of the corresponding source code, to be distributed under the terms of Sections 1 and 2 above on a medium customarily used for software interchange; or,
 - c) Accompany it with the information you received as to the offer to distribute corresponding source code. (This alternative is allowed only for noncommercial distribution and only if you received the program in object code or executable form with such an offer, in accord with Subsection b above.)

The source code for a work means the preferred form of the work for making modifications to it. For an executable work, complete source code means all the source code for all modules it contains, plus any associated interface definition files, plus the scripts used to control compilation and installation of the executable. However, as a special exception, the source code distributed need not include anything that is normally distributed (in either source or binary form) with the major components (compiler, kernel, and so on) of the operating system on which the executable runs, unless that component itself accompanies the executable.

If distribution of executable or object code is made by offering access to copy from a designated place, then offering equivalent access to copy the source code from the same place counts as distribution of the source code, even though third parties are not compelled to copy the source along with the object code.

4. You may not copy, modify, sublicense, or distribute the Program except as expressly provided under this License. Any attempt otherwise to copy, modify, sublicense or distribute the Program is void, and will automatically terminate your rights under this License. However, parties who have received copies, or rights, from you under this License will not have their licenses terminated so long as such parties remain in full compliance.
5. You are not required to accept this License, since you have not signed it. However, nothing else grants you permission to modify or distribute the Program or its derivative works. These actions are prohibited by law if you do not accept this License. Therefore, by modifying or distributing the Program (or any work based on the Program), you indicate your acceptance of this License to do so, and all its terms and conditions for copying, distributing or modifying the Program or works based on it.
6. Each time you redistribute the Program (or any work based on the Program), the recipient automatically receives a license from the original licensor to copy, distribute or modify the Program subject to these terms and conditions. You may not impose any further restrictions on the recipients' exercise of the rights granted herein. You are not responsible for enforcing compliance by third parties to this License.
7. If, as a consequence of a court judgment or allegation of patent infringement or for any other reason (not limited to patent issues), conditions are imposed on you (whether by court order, agreement or otherwise) that contradict the conditions of this License, they do not excuse you from the conditions of this License. If you cannot distribute so as to satisfy simultaneously your obligations under this License and any other pertinent obligations, then as a consequence you may not distribute the Program at all. For example, if a patent license would not permit royalty-free redistribution of the Program by all those who receive copies directly or indirectly through you, then the only way you could satisfy both it and this License would be to refrain entirely from distribution of the Program.

If any portion of this section is held invalid or unenforceable under any particular circumstance, the balance of the section is intended to apply and the section as a whole is intended to apply in other circumstances.

It is not the purpose of this section to induce you to infringe any patents or other property right claims or to contest validity of any such claims; this section has the sole purpose of protecting the integrity of the free software distribution system, which is implemented by public license practices. Many people have made generous contributions to the wide range of software distributed through that system in reliance on consistent application of that system; it is up to the author/donor to decide if he or she is willing to distribute software through any other system and a licensee cannot impose that choice.

This section is intended to make thoroughly clear what is believed to be a consequence of the rest of this License.

8. If the distribution and/or use of the Program is restricted in certain countries either by patents or by copyrighted interfaces, the original copyright holder who places the Program under this License may add an explicit geographical distribution limitation excluding those countries, so that distribution is permitted only in or among countries not thus excluded. In such case, this License incorporates the limitation as if written in the body of this License.
9. The Free Software Foundation may publish revised and/or new versions of the General Public License from time to time. Such new versions will be similar in spirit to the present version, but may differ in detail to address new problems or concerns.

Each version is given a distinguishing version number. If the Program specifies a version number of this License which applies to it and “any later version”, you have the option of following the terms and conditions either of that version or of any later version published by the Free Software Foundation. If the Program does not specify a version number of this License, you may choose any version ever published by the Free Software Foundation.

10. If you wish to incorporate parts of the Program into other free programs whose distribution conditions are different, write to the author to ask for permission. For software which is copyrighted by the Free Software Foundation, write to the Free Software Foundation; we sometimes make exceptions for this. Our decision will be guided by the two goals of preserving the free status of all derivatives of our free software and of promoting the sharing and reuse of software generally.

NO WARRANTY

11. BECAUSE THE PROGRAM IS LICENSED FREE OF CHARGE, THERE IS NO WARRANTY FOR THE PROGRAM, TO THE EXTENT PERMITTED BY APPLICABLE LAW. EXCEPT WHEN OTHERWISE STATED IN WRITING THE COPYRIGHT HOLDERS AND/OR OTHER PARTIES PROVIDE THE PROGRAM “AS IS” WITHOUT WARRANTY OF ANY KIND, EITHER EXPRESSED OR IMPLIED, INCLUDING, BUT NOT LIMITED TO, THE IMPLIED WARRANTIES OF MERCHANTABILITY AND FITNESS FOR A PARTICULAR PURPOSE. THE ENTIRE RISK AS TO THE QUALITY AND PERFORMANCE OF THE PROGRAM IS WITH YOU. SHOULD THE PROGRAM PROVE DEFECTIVE, YOU ASSUME THE COST OF ALL NECESSARY SERVICING, REPAIR OR CORRECTION.
12. IN NO EVENT UNLESS REQUIRED BY APPLICABLE LAW OR AGREED TO IN WRITING WILL ANY COPYRIGHT HOLDER, OR ANY OTHER PARTY WHO MAY MODIFY AND/OR REDISTRIBUTE THE PROGRAM AS PERMITTED ABOVE, BE LIABLE TO YOU FOR DAMAGES, INCLUDING ANY GENERAL, SPECIAL, INCIDENTAL OR CONSEQUENTIAL DAMAGES ARISING OUT OF THE USE OR INABILITY TO USE THE PROGRAM (INCLUDING BUT NOT LIMITED TO LOSS OF DATA OR DATA BEING RENDERED INACCURATE OR LOSSES SUSTAINED BY YOU OR THIRD PARTIES OR A FAILURE OF THE PROGRAM TO OPERATE WITH ANY OTHER PROGRAMS), EVEN IF SUCH HOLDER OR OTHER PARTY HAS BEEN ADVISED OF THE POSSIBILITY OF SUCH DAMAGES.

END OF TERMS AND CONDITIONS

How to Apply These Terms to Your New Programs

If you develop a new program, and you want it to be of the greatest possible use to the public, the best way to achieve this is to make it free software which everyone can redistribute and change under these terms.

To do so, attach the following notices to the program. It is safest to attach them to the start of each source file to most effectively convey the exclusion of warranty; and each file should have at least the “copyright” line and a pointer to where the full notice is found.

<one line to give the program’s name and a brief idea of what it does.>

Copyright (C) <year> <name of author>

This program is free software; you can redistribute it and/or modify it under the terms of the GNU General Public License as published by the Free Software Foundation; either version 2 of the License, or (at your option) any later version.

This program is distributed in the hope that it will be useful, but WITHOUT ANY WARRANTY; without even the implied warranty of MERCHANTABILITY or FITNESS FOR A PARTICULAR PURPOSE. See the GNU General Public License for more details.

You should have received a copy of the GNU General Public License along with this program; if not, write to the Free Software Foundation, Inc., 59 Temple Place, Suite 330, Boston, MA 02111-1307 USA.

Also add information on how to contact you by electronic and paper mail.

If the program is interactive, make it output a short notice like this when it starts in an interactive mode:

Gnomovision version 69, Copyright (C) year name of author Gnomovision comes with ABSOLUTELY NO WARRANTY; for details type ‘show w’. This is free software, and you are welcome to redistribute it under certain conditions; type ‘show c’ for details.

The hypothetical commands ‘show w’ and ‘show c’ should show the appropriate parts of the General Public License. Of course, the commands you use may be called something other than ‘show w’ and ‘show c’; they could even be mouse-clicks or menu items—whatever suits your program.

You should also get your employer (if you work as a programmer) or your school, if any, to sign a “copyright disclaimer” for the program, if necessary. Here is a sample; alter the names:

Yoyodyne, Inc., hereby disclaims all copyright interest in the program ‘Gnomovision’ (which makes passes at compilers) written by James Hacker.

<signature of Ty Coon>, 1 April 1989

Ty Coon, President of Vice

This General Public License does not permit incorporating your program into proprietary programs. If your program is a subroutine library, you may consider it more useful to permit linking proprietary applications with the library. If this is what you want to do, use the GNU Library General Public License instead of this License.

■ GNU LESSER GENERAL PUBLIC LICENSE

Version 2.1, February 1999

Copyright (C) 1991, 1999 Free Software Foundation, Inc.
59 Temple Place, Suite 330, Boston, MA 02111-1307 USA

Everyone is permitted to copy and distribute verbatim copies of this license document, but changing it is not allowed.

[This is the first released version of the Lesser GPL. It also counts as the successor of the GNU Library Public License, version 2, hence the version number 2.1.]

Preamble

The licenses for most software are designed to take away your freedom to share and change it. By contrast, the GNU General Public Licenses are intended to guarantee your freedom to share and change free software—to make sure the software is free for all its users.

This license, the Lesser General Public License, applies to some specially designated software packages—typically libraries—of the Free Software Foundation and other authors who decide to use it. You can use it too, but we suggest you first think carefully about whether this license or the ordinary General Public License is the better strategy to use in any particular case, based on the explanations below.

When we speak of free software, we are referring to freedom of use, not price. Our General Public Licenses are designed to make sure that you have the freedom to distribute copies of free software (and charge for this service if you wish); that you receive source code or can get it if you want it; that you can change the software and use pieces of it in new free programs; and that you are informed that you can do these things.

To protect your rights, we need to make restrictions that forbid distributors to deny you these rights or to ask you to surrender these rights. These restrictions translate to certain responsibilities for you if you distribute copies of the library or if you modify it.

For example, if you distribute copies of the library, whether gratis or for a fee, you must give the recipients all the rights that we gave you. You must make sure that they, too, receive or can get the source code. If you link other code with the library, you must provide complete object files to the recipients, so that they can relink them with the library after making changes to the library and recompiling it. And you must show them these terms so they know their rights.

We protect your rights with a two-step method: (1) we copyright the library, and (2) we offer you this license, which gives you legal permission to copy, distribute and/or modify the library.

To protect each distributor, we want to make it very clear that there is no warranty for the free library. Also, if the library is modified by someone else and passed on, the recipients should know that what they have is not the original version, so that the original author’s reputation will not be affected by problems that might be introduced by others.

Finally, software patents pose a constant threat to the existence of any free program. We wish to make sure that a company cannot effectively restrict the users of a free program by obtaining a restrictive license from a patent holder. Therefore, we insist that any patent license obtained for a version of the library must be consistent with the full freedom of use specified in this license.

Most GNU software, including some libraries, is covered by the ordinary GNU General Public License. This license, the GNU Lesser General Public License, applies to certain designated libraries, and is quite different from the ordinary General Public License. We use this license for certain libraries in order to permit linking those libraries into non-free programs.

When a program is linked with a library, whether statically or using a shared library, the combination of the two is legally speaking a combined work, a derivative of the original library. The ordinary General Public License therefore permits such linking only if the entire combination fits its criteria of freedom. The Lesser General Public License permits more lax criteria for linking other code with the library.

We call this license the “Lesser” General Public License because it does Less to protect the user’s freedom than the ordinary General Public License. It also provides other free software developers Less of an advantage over competing non-free programs. These disadvantages are the reason we use the ordinary General Public License for many libraries.

However, the Lesser license provides advantages in certain special circumstances.

For example, on rare occasions, there may be a special need to encourage the widest possible use of a certain library, so that it becomes a de-facto standard. To achieve this, non-free programs must be allowed to use the library. A more frequent case is that a free library does the same job as widely used non-free libraries. In this case, there is little to gain by limiting the free library to free software only, so we use the Lesser General Public License.

In other cases, permission to use a particular library in non-free programs enables a greater number of people to use a large body of free software. For example, permission to use the GNU C Library in non-free programs enables many more people to use the whole GNU operating system, as well as its variant, the GNU/Linux operating system.

Although the Lesser General Public License is less protective of the users' freedom, it does ensure that the user of a program that is linked with the Library has the freedom and the wherewithal to run that program using a modified version of the Library.

The precise terms and conditions for copying, distribution and modification follow. Pay close attention to the difference between a "work based on the library" and a "work that uses the library". The former contains code derived from the library, whereas the latter must be combined with the library in order to run.

TERMS AND CONDITIONS FOR COPYING, DISTRIBUTION AND MODIFICATION

0. This License Agreement applies to any software library or other program which contains a notice placed by the copyright holder or other authorized party saying it may be distributed under the terms of this Lesser General Public License (also called "this License"). Each licensee is addressed as "you".

A "library" means a collection of software functions and/or data prepared so as to be conveniently linked with application programs (which use some of those functions and data) to form executables.

The "Library", below, refers to any such software library or work which has been distributed under these terms. A "work based on the Library" means either the Library or any derivative work under copyright law; that is to say, a work containing the Library or a portion of it, either verbatim or with modifications and/or translated straightforwardly into another language. (Hereinafter, translation is included without limitation in the term "modification".)

"Source code" for a work means the preferred form of the work for making modifications to it. For a library, complete source code means all the source code for all modules it contains, plus any associated interface definition files, plus the scripts used to control compilation and installation of the library.

Activities other than copying, distribution and modification are not covered by this License; they are outside its scope. The act of running a program using the Library is not restricted, and output from such a program is covered only if its contents constitute a work based on the Library (independent of the use of the Library in a tool for writing it). Whether that is true depends on what the Library does and what the program that uses the Library does.

1. You may copy and distribute verbatim copies of the Library's complete source code as you receive it, in any medium, provided that you conspicuously and appropriately publish on each copy an appropriate copyright notice and disclaimer of warranty; keep intact all the notices that refer to this License and to the absence of any warranty; and distribute a copy of this License along with the Library.

You may charge a fee for the physical act of transferring a copy, and you may at your option offer warranty protection in exchange for a fee.

2. You may modify your copy or copies of the Library or any portion of it, thus forming a work based on the Library, and copy and distribute such modifications or work under the terms of Section 1 above, provided that you also meet all of these conditions:

- The modified work must itself be a software library.
- You must cause the files modified to carry prominent notices stating that you changed the files and the date of any change.
- You must cause the whole of the work to be licensed at no charge to all third parties under the terms of this License.
- If a facility in the modified Library refers to a function or a table of data to be supplied by an application program that uses the facility, other than as an argument passed when the facility is invoked, then you must make a good faith effort to ensure that, in the event an application does not supply such function or table, the facility still operates, and performs whatever part of its purpose remains meaningful.

(For example, a function in a library to compute square roots has a purpose that is entirely well-defined independent of the application. Therefore, Subsection 2d requires that any application-supplied function or table used by this function must be optional: if the application does not supply it, the square root function must still compute square roots.)

These requirements apply to the modified work as a whole. If identifiable sections of that work are not derived from the Library, and can be reasonably considered independent and separate works in themselves, then this License, and its terms, do not apply to those sections when you distribute them as separate works. But when you distribute the same sections as part of a whole which is a work based on the Library, the distribution of the whole must be on the terms of this License, whose permissions for other licensees extend to the entire whole, and thus to each and every part regardless of who wrote it.

Thus, it is not the intent of this section to claim rights or contest your rights to work

written entirely by you; rather, the intent is to exercise the right to control the distribution of derivative or collective works based on the Library.

In addition, mere aggregation of another work not based on the Library with the Library (or with a work based on the Library) on a volume of a storage or distribution medium does not bring the other work under the scope of this License.

3. You may opt to apply the terms of the ordinary GNU General Public License instead of this License to a given copy of the Library. To do this, you must alter all the notices that refer to this License, so that they refer to the ordinary GNU General Public License, version 2, instead of to this License. (If a newer version than version 2 of the ordinary GNU General Public License has appeared, then you can specify that version instead if you wish.) Do not make any other change in these notices.

Once this change is made in a given copy, it is irreversible for that copy, so the ordinary GNU General Public License applies to all subsequent copies and derivative works made from that copy.

This option is useful when you wish to copy part of the code of the Library into a program that is not a library.

4. You may copy and distribute the Library (or a portion or derivative of it, under Section 2) in object code or executable form under the terms of Sections 1 and 2 above provided that you accompany it with the complete corresponding machine-readable source code, which must be distributed under the terms of Sections 1 and 2 above on a medium customarily used for software interchange.

If distribution of object code is made by offering access to copy from a designated place, then offering equivalent access to copy the source code from the same place satisfies the requirement to distribute the source code, even though third parties are not compelled to copy the source along with the object code.

5. A program that contains no derivative of any portion of the Library, but is designed to work with the Library by being compiled or linked with it, is called a "work that uses the Library". Such a work, in isolation, is not a derivative work of the Library, and therefore falls outside the scope of this License.

However, linking a "work that uses the Library" with the Library creates an executable that is a derivative of the Library (because it contains portions of the Library), rather than a "work that uses the library". The executable is therefore covered by this License. Section 6 states terms for distribution of such executables.

When a "work that uses the Library" uses material from a header file that is part of the Library, the object code for the work may be a derivative work of the Library even though the source code is not. Whether this is true is especially significant if the work can be linked without the Library, or if the work is itself a library. The threshold for this to be true is not precisely defined by law.

If such an object file uses only numerical parameters, data structure layouts and accessors, and small macros and small inline functions (ten lines or less in length), then the use of the object file is unrestricted, regardless of whether it is legally a derivative work. (Executables containing this object code plus portions of the Library will still fall under Section 6.)

Otherwise, if the work is a derivative of the Library, you may distribute the object code for the work under the terms of Section 6. Any executables containing that work also fall under Section 6, whether or not they are linked directly with the Library itself.

6. As an exception to the Sections above, you may also combine or link a "work that uses the Library" with the Library to produce a work containing portions of the Library, and distribute that work under terms of your choice, provided that the terms permit modification of the work for the customer's own use and reverse engineering for debugging such modifications.

You must give prominent notice with each copy of the work that the Library is used in it and that the Library and its use are covered by this License. You must supply a copy of this License. If the work during execution displays copyright notices, you must include the copyright notice for the Library among them, as well as a reference directing the user to the copy of this License. Also, you must do one of these things:

- Accompany the work with the complete corresponding machine-readable source code for the Library including whatever changes were used in the work (which must be distributed under Sections 1 and 2 above); and, if the work is an executable linked with the Library, with the complete machine-readable "work that uses the Library", as object code and/or source code, so that the user can modify the Library and then relink to produce a modified executable containing the modified Library. (It is understood that the user who changes the contents of definitions files in the Library will not necessarily be able to recompile the application to use the modified definitions.)
- Use a suitable shared library mechanism for linking with the Library. A suitable mechanism is one that (1) uses at run time a copy of the library already present on the user's computer system, rather than copying library functions into the executable, and (2) will operate properly with a modified version of the library, if the user installs one, as long as the modified version is interface-compatible with the version that the work was made with.
- Accompany the work with a written offer, valid for at least three years, to give the same user the materials specified in Subsection 6a, above, for a charge no more than the cost of performing this distribution.

- d) If distribution of the work is made by offering access to copy from a designated place, offer equivalent access to copy the above specified materials from the same place.
- e) Verify that the user has already received a copy of these materials or that you have already sent this user a copy.

For an executable, the required form of the “work that uses the Library” must include any data and utility programs needed for reproducing the executable from it. However, as a special exception, the materials to be distributed need not include anything that is normally distributed (in either source or binary form) with the major components (compiler, kernel, and so on) of the operating system on which the executable runs, unless that component itself accompanies the executable.

It may happen that this requirement contradicts the license restrictions of other proprietary libraries that do not normally accompany the operating system. Such a contradiction means you cannot use both them and the Library together in an executable that you distribute.

7. You may place library facilities that are a work based on the Library side-by-side in a single library together with other library facilities not covered by this License, and distribute such a combined library, provided that the separate distribution of the work based on the Library and of the other library facilities is otherwise permitted, and provided that you do these two things:
 - a) Accompany the combined library with a copy of the same work based on the Library, uncombined with any other library facilities. This must be distributed under the terms of the Sections above.
 - b) Give prominent notice with the combined library of the fact that part of it is a work based on the Library, and explaining where to find the accompanying uncombined form of the same work.
8. You may not copy, modify, sublicense, link with, or distribute the Library except as expressly provided under this License. Any attempt otherwise to copy, modify, sublicense, link with, or distribute the Library is void, and will automatically terminate your rights under this License. However, parties who have received copies, or rights, from you under this License will not have their licenses terminated so long as such parties remain in full compliance.
9. You are not required to accept this License, since you have not signed it. However, nothing else grants you permission to modify or distribute the Library or its derivative works. These actions are prohibited by law if you do not accept this License. Therefore, by modifying or distributing the Library (or any work based on the Library), you indicate your acceptance of this License to do so, and all its terms and conditions for copying, distributing or modifying the Library or works based on it.
10. Each time you redistribute the Library (or any work based on the Library), the recipient automatically receives a license from the original licensor to copy, distribute, link with or modify the Library subject to these terms and conditions. You may not impose any further restrictions on the recipients' exercise of the rights granted herein. You are not responsible for enforcing compliance by third parties with this License.
11. If, as a consequence of a court judgment or allegation of patent infringement or for any other reason (not limited to patent issues), conditions are imposed on you (whether by court order, agreement or otherwise) that contradict the conditions of this License, they do not excuse you from the conditions of this License. If you cannot distribute so as to satisfy simultaneously your obligations under this License and any other pertinent obligations, then as a consequence you may not distribute the Library at all. For example, if a patent license would not permit royalty-free redistribution of the Library by all those who receive copies directly or indirectly through you, then the only way you could satisfy both it and this License would be to refrain entirely from distribution of the Library.

If any portion of this section is held invalid or unenforceable under any particular circumstance, the balance of the section is intended to apply, and the section as a whole is intended to apply in other circumstances.

It is not the purpose of this section to induce you to infringe any patents or other property right claims or to contest validity of any such claims; this section has the sole purpose of protecting the integrity of the free software distribution system which is implemented by public license practices. Many people have made generous contributions to the wide range of software distributed through that system in reliance on consistent application of that system; it is up to the author/donor to decide if he or she is willing to distribute software through any other system and a licensee cannot impose that choice.

This section is intended to make thoroughly clear what is believed to be a consequence of the rest of this License.

12. If the distribution and/or use of the Library is restricted in certain countries either by patents or by copyrighted interfaces, the original copyright holder who places the Library under this License may add an explicit geographical distribution limitation excluding those countries, so that distribution is permitted only in or among countries not thus excluded. In such case, this License incorporates the limitation as if written in the body of this License.
13. The Free Software Foundation may publish revised and/or new versions of the Lesser General Public License from time to time. Such new versions will be similar in spirit to the present version, but may differ in detail to address new problems or concerns.

Each version is given a distinguishing version number. If the Library specifies a version number of this License which applies to it and “any later version”, you have the option of following the terms and conditions either of that version or of any later version published by the Free Software Foundation. If the Library does not specify a license version number, you may choose any version ever published by the Free Software Foundation.

14. If you wish to incorporate parts of the Library into other free programs whose distribution conditions are incompatible with these, write to the author to ask for permission. For software which is copyrighted by the Free Software Foundation, write to the Free Software Foundation; we sometimes make exceptions for this. Our decision will be guided by the two goals of preserving the free status of all derivatives of our free software and of promoting the sharing and reuse of software generally.

NO WARRANTY

15. BECAUSE THE LIBRARY IS LICENSED FREE OF CHARGE, THERE IS NO WARRANTY FOR THE LIBRARY, TO THE EXTENT PERMITTED BY APPLICABLE LAW. EXCEPT WHEN OTHERWISE STATED IN WRITING THE COPYRIGHT HOLDERS AND/OR OTHER PARTIES PROVIDE THE LIBRARY “AS IS” WITHOUT WARRANTY OF ANY KIND, EITHER EXPRESSED OR IMPLIED, INCLUDING, BUT NOT LIMITED TO, THE IMPLIED WARRANTIES OF MERCHANTABILITY AND FITNESS FOR A PARTICULAR PURPOSE. THE ENTIRE RISK AS TO THE QUALITY AND PERFORMANCE OF THE LIBRARY IS WITH YOU. SHOULD THE LIBRARY PROVE DEFECTIVE, YOU ASSUME THE COST OF ALL NECESSARY SERVICING, REPAIR OR CORRECTION.
16. IN NO EVENT UNLESS REQUIRED BY APPLICABLE LAW OR AGREED TO IN WRITING WILL ANY COPYRIGHT HOLDER, OR ANY OTHER PARTY WHO MAY MODIFY AND/OR REDISTRIBUTE THE LIBRARY AS PERMITTED ABOVE, BE LIABLE TO YOU FOR DAMAGES, INCLUDING ANY GENERAL, SPECIAL, INCIDENTAL OR CONSEQUENTIAL DAMAGES ARISING OUT OF THE USE OR INABILITY TO USE THE LIBRARY (INCLUDING BUT NOT LIMITED TO LOSS OF DATA OR DATA BEING RENDERED INACCURATE OR LOSSES SUSTAINED BY YOU OR THIRD PARTIES OR A FAILURE OF THE LIBRARY TO OPERATE WITH ANY OTHER SOFTWARE), EVEN IF SUCH HOLDER OR OTHER PARTY HAS BEEN ADVISED OF THE POSSIBILITY OF SUCH DAMAGES.

END OF TERMS AND CONDITIONS

How to Apply These Terms to Your New Libraries

If you develop a new library, and you want it to be of the greatest possible use to the public, we recommend making it free software that everyone can redistribute and change. You can do so by permitting redistribution under these terms (or, alternatively, under the terms of the ordinary General Public License).

To apply these terms, attach the following notices to the library. It is safest to attach them to the start of each source file to most effectively convey the exclusion of warranty; and each file should have at least the “copyright” line and a pointer to where the full notice is found.

<one line to give the library's name and a brief idea of what it does.>

Copyright (C) <year> <name of author>

This library is free software; you can redistribute it and/or modify it under the terms of the GNU Lesser General Public License as published by the Free Software Foundation; either version 2.1 of the License, or (at your option) any later version.

This library is distributed in the hope that it will be useful, but WITHOUT ANY WARRANTY; without even the implied warranty of MERCHANTABILITY or FITNESS FOR A PARTICULAR PURPOSE. See the GNU Lesser General Public License for more details.

You should have received a copy of the GNU Lesser General Public License along with this library; if not, write to the Free Software Foundation, Inc., 59 Temple Place, Suite 330, Boston, MA 02111-1307 USA

Also add information on how to contact you by electronic and paper mail.

You should also get your employer (if you work as a programmer) or your school, if any, to sign a “copyright disclaimer” for the library, if necessary. Here is a sample; alter the names:

Yoodyne, Inc., hereby disclaims all copyright interest in the library ‘Frob’ (a library for tweaking knobs) written by James Random Hacker.

<signature of Ty Coon>, 1 April 1990

Ty Coon, President of Vice

That's all there is to it!

List of remote control codes

CABLE

ABC	0030, 0035
AMERICAST	0926
BELL SOUTH	0926
BIRMINGHAM CABLE COMMUNICATIONS	0303
BRITISH TELECOM	0030
CABLE & WIRELESS	1095
DAERYUNG	0035, 0504, 0904, 1904
DIRECTOR	0503
FILMNET	0470
GENERAL INSTRUMENT	0030, 0303, 0503, 0837,
GOLDSTAR	0171
HAMLIN	0036, 0300
JERROLD	0030, 0303, 0503, 0837
LG	0171
MNET	0470
MEMOREX	0027
MOTOROLA	0303, 0503, 0837, 1133
NTL	1095
NOOS	0844
ONO	1095
PVP STEREO VISUAL MATRIX	0030
PACE	0264, 1087, 1095
PANASONIC	0027, 0035, 0134
PARAGON	0027
PHILIPS	0332, 0344
PIONEER	0171, 0560, 0904, 1904
PULSAR	0027
QUASAR	0027
REGAL	0300, 0306
RUNCO	0027
SAGEM	0844
SAMSUNG	0027, 0171
SCIENTIFIC ATLANTA	0035, 0504, 0904, 1904
SONY	1033
STARCOM	0030
SUPERCABLE	0303
TS	0030
TELE+1	0470
TELEWEST	1095
TORX	0030
TOSHIBA	0027
TRANS PX	0303
UNITED CABLE	0030
ZENITH	0027, 0552, 0926

CD PLAYER

AIWA	0184
ARCAM	0184
AUDIO RESEARCH	0184
AUDIO TON	0184
AUDIOLAB	0184
AUDIOMECA	0184
CAIRN	0184

CALIFORNIA AUDIO LABS

	0056
CARVER	0184, 0206
CYRUS	0184
DKK	0027
DMX ELECTRONICS	0184
DENON	0900
DYNAMIC BASS	0206
EMERSON	0332
FISHER	0206
GENEXXA	0059, 0332
GOODMANS	0332
GRUNDIG	0184
HARMAN/KARDON	0184, 0200
HITACHI	0059
JVC	0099
KENWOOD	0055, 0064
KRELL	0184
LXI	0332
LINN	0184
MCS	0056
MAGNAVOX	0184, 0332
MARANTZ	0056, 0184
MATSUI	0184
MEMOREX	0332
MERIDIAN	0184
MICROMEGA	0184
MIRO	0027
MISSION	0184
MYRYAD	0184
NAD	0027
NSM	0184
NAIM	0184
OPTIMUS	0027, 0059, 0064, 0206, 0332
PANASONIC	0056
PHILIPS	0184
PIONEER	0059, 0332
POLK AUDIO	0184
PROTON	0184
QED	0184
QUAD	0184
QUASAR	0056
RCA	0059, 0206, 0332
REALISTIC	0206
REVOX	0184
ROTEL	0184
SAE	0184
SANSUI	0184, 0332
SANYO	0206
SCOTT	0332
SEARS	0332
SHARP	0064
SIMAUDIO	0184
SONIC FRONTIERS	0184
SONY	0027
SYMPHONIC	0332
TAG MCLAREN	0184
TANDY	0059
TECHNICS	0056
THORENS	0184
THULE	0184
UNIVERSUM	0184
VICTOR	0099
WARDS	0184
Yamaha	2300, 2301

CD RECORDER

KENWOOD	0653
MARANTZ	0653
PHILIPS	0653
Yamaha	2400

DVD PLAYER

ACOUSTIC SOLUTIONS	0757
ALBA	0744
AMSTRAD	0740
APEX DIGITAL	0699, 0744, 0782, 0821, 0823, 0857, 1127
BLAUPINKT	0744
BLUE PARADE	0598
BUSH	0740
CENTREX	0699
CLATRONIC	0815
CYBERHOME	0741
DVD2000	0548
DAEWOO	0811, 0797
DANSAI	0797
DECCA	0797
DENON	0517
DIAMOND	0795
DIGITREX	0699
EMERSON	0618
ENTERPRISE	0618
FISHER	0697
GE	0549, 0744
GO VIDEO	0742
GOLDSTAR	0768
GRADIENTE	0678
GREENHILL	0744
GRUNDIG	0566
HITACHI	0600, 0691
HITEKER	0699
JVC	0585, 0650
KLH	0744
KENWOOD	0517, 0561
KOSS	0678
LG	0768
LIMIT	0795
MAGNAVOX	0530, 0702
MARANTZ	0566
MEMOREX	0858
MICO	0750
MICROSOFT	0549
MINTEK	0744
MITSUBISHI	0548
MUSTEK	0757
NESA	0744
ONKYO	0530
ORITRON	0678
PALSONIC	0699
PANASONIC	0517, 0659, 1389
PHILIPS	0530, 0566, 0673, 0881
PIONEER	0552, 0598, 0658, 0659
POLK AUDIO	0566
PROSCAN	0549
QWESTAR	0678
RCA	0549, 0598, 0744
ROTEL	0650

SM ELECTRONIC	0757
SAMSUNG	0600
SANYO	0697
SHARP	0657
SHERWOOD	0797
SHINSONIC	0560
SLIM ART	0811
SONY	0560, 0891
SYLVANIA	0702
TATUNG	0797
TEAC	0598, 0744
TECHNICS	0517
THETA DIGITAL	0598
THOMSON	0549
TOSHIBA	0530
URBAN CONCEPTS	0530
XBOX	0549
Yamaha	0517, 0566, 0572, 2100
ZENITH	0530, 0618, 0768
ZEUS	0811

HD DVD PLAYER

TOSHIBA	2103
---------	------

DVD RECORDER

PANASONIC	2800, 2801, 2802
PHILIPS	2808
SHARP	2812, 2813
SONY	2809, 2810, 2811
Yamaha	2807

Blu-ray Disc player

PANASONIC	2800, 2801, 2802
SAMSUNG	2816

LD PLAYER

CARVER	0091
DENON	0086
MARANTZ	0091
MITSUBISHI	0086
NAD	0086
NAGSMI	0086
OPTIMUS	0086
PHILIPS	0091
PIONEER	0086
SALORA	0091
SONY	0228
TELEFUNKEN	0086
Yamaha	2200

MD RECORDER

KENWOOD	0708
ONKYO	0895
SHARP	0888
SONY	0517
Yamaha	2500, 2501, 2502

RECEIVER (TUNER)

ADC	0558
AIWA	0185, 1116, 1415, 1432, 1668
ALCO	1417
ANAM	1636
APEX DIGITAL	1284
AUDIOLAB	1216
AUDIOTRONIC	1216

AUDIOVOX 1417
BOSE 1256
CAMBRIDGE SOUNDWORKS
1397
CAPETRONIC 0558
CARVER 1116, 1216
CENTREX 1284
DENON 1387
FERGUSON 0558
FINE ARTS 1216
GRUNDIG 1216
HARMAN/KARDON
0137, 1331
INTEGRA 0162, 1325
JBL 0137, 1333
JVC 0101, 0558, 1401,
1522
KLH 1417, 1439
KENWOOD 1054, 1340
MCS 0066
MAGNAVOX 0558, 1116, 1216,
1296,
MARANTZ 0066, 1116, 1216,
1316
MICROMEGA 1216
MUSICMAGIC 1116
MYRYAD 1216
NAD 0347
NORCENT 1416
ONKYO 0162, 0869, 1325
OPTIMUS 0558, 1050
PANASONIC 0066, 1315, 1545,
1790
PHILIPS 1116, 1216, 1293,
1295, 1296, 1310,
1316
PIONEER 0041, 0558, 1050,
1411
POLK AUDIO 1316
PROSCAN 1281
QUASAR 0066
RCA 0558, 1050, 1281,
1417, 1636,
SABA 0558
SANSUI 1116
SCHNEIDER 0558
SONY 0185, 1085, 1185,
1685, 1785
STEREOPHONICS 1050
SUNFIRE 1340
TEAC 1417
TECHNICS 0066, 1335, 1336,
1545
TELEFUNKEN 0558
THOMSON 1281
THORENS 1216
UHER 0558
VENTURER 1417
VICTOR 0101
WARDS 0041, 0185
Yamaha 0203, 1203, 1358,
2601
(TUNER ID1) 2602
(TUNER ID2) 2603
(XM ID1) 2604
(XM ID2) 2605
(iPod) 2606

SATELLITE TUNER

@SAT 1327
ABSAT 0150
ALBA 0482
ALPHASTAR 0799
AMSTRAD 0874
ASTON 0169, 1156
ASTRO 0200
ATSAT 1327
AVALON 0423
BLAUPUNKT 0200
BRITISH SKY BROADCASTING
0874, 1202
CANAL DIGITAL 0880
CANAL SATELLITE 0880
CANAL+ 0880
CHAPARRAL 0243
CITYCOM 1203
CONNEXIONS 0423
CROSSDIGITAL 1136
CYRUS 0227
D-BOX 0750, 1154
DMT 1102
DNT 0227, 0423
DAERYUNG 0423
DAEWOO 1323
DIGENIUS 0326
DIRECTV 0274, 0419, 0593,
0666, 0751, 0776,
0846, 1103, 1136,
1169, 1776, 1883
DISH NETWORK SYSTEM
0802, 1032
DISHPRO 0802, 1032
DISTRATEL 0111
DREAM MULTIMEDIA
1264
ECHOSTAR 0194, 0423, 0637,
0802, 0880, 0898,
1032, 1113
ENGEL 1044
EXPRESSVU 0802
FTE 0890
FINLUX 0482
FRACARRO 0898
FUBA 0423
GE 0593
GOI 0802
GALAXIS 0890, 1138
GENERAL INSTRUMENT
0896
GOLD BOX 0880
GRUNDIG 0200, 0874
HTS 0802
HIRSCHMANN 0200, 0423
HITACHI 0482, 0846
HUGHES NETWORK SYSTEM
0776, 1169, 1776
HUMAX 0890, 1203
INVIDEO 0898
JVC 0802
KATHREIN 0150, 0200, 0227,
0276, 0685, 1248
KREISELMEYER 0200
LABGEAR 1323
LOGIX 1044
LORENZEN 0326
MAGNAVOX 0749, 0751
MANHATTAN 0482, 1044,
1110
MARANTZ 0227
MEDIASAT 0880
MEMOREX 0751
METRONIC 0111
MITSUBISHI 0776
MOTOROLA 0896
MYRYAD 0227
NEXT LEVEL 0896
NOKIA 0482, 0750, 0778,
1154, 1250, 1750
OCTALTV 1032

ORBITECH 1127
PACE 0482, 0874, 1202,
1350
PANASONIC 0274, 0728, 0874,
1347
PANDA 0482
PAYSAT 0751
PHILIPS 0160, 0227, 0482,
0749, 0751, 0776,
0880, 1103, 1169,
1776
PIONEER 0880
PROMAX 0482
PROSCAN 0419, 0593
RCA 0170, 0419, 0593,
0882
RFT 0227
RADIOSHACK 0896
RADIOLA 0227
RADIX 0423
SKY 0874, 0883, 1202
SM ELECTRONIC 1227
SABRE 0482
SAGEM 0847, 1141, 1280
SAMSUNG 1044, 1136, 1303,
1319
SAT CONTROL 1327
SATSTATION 1110
SCHWAIGER 1138
SEEMANN 0423
SIEMENS 0200
SONY 0666, 0874, 1666
STAR CHOICE 0896
STRONG 1327
TPS 0847, 1280
TANTEC 0482
TECHNISAT 1126, 1127
TELESTAR 1127
THOMSON 0482, 0880, 1073,
1318
TOPFIELD 1233
TOSHIBA 0776, 0817, 1776
ULTIMATETV 0419, 0666
UNIDEN 0749, 0751
UNIVERSUM 0200
VENTANA 0227
WISI 0200, 0423, 0482
XSAT 0150
ZEHNDER 1102
ZENITH 0883, 1883

TAPE DECK

AIWA 0056
CARVER 0056
GRUNDIG 0056
HARMAN/KARDON
0056
MAGNAVOX 0056
MARANTZ 0056
MYRYAD 0056
OPTIMUS 0054
PHILIPS 0056
PIONEER 0054
POLK AUDIO 0056
RCA 0054
REVOX 0056
SANSUI 0056
SONY 0270
THORENS 0056
WARDS 0054
Yamaha 2700,2701

TV

AGB 0543
AOC 0036, 0057, 0087,
0119, 0120, 0135,
0205, 0207, 0478
0131
ASA 0036
ACURA 0036
ADDISON 0119, 0135, 0680
ADMIRAL 0120, 0190, 0490
ADVENT 0788
AIKO 0119
AKAI 0036, 0057, 0235,
0388, 0543, 0729,
0839
AKURA 0291
ALBA 0036, 0064, 0398,
0695
AMERICA ACTION 0207
AMPRO 0778
AMSTRAD 0036, 0064, 0198,
0398, 0439, 0460,
0543
ANAM 0036, 0207, 0277
ANAM NATIONAL 0277, 0677
ANITECH 0036
APEX DIGITAL 0775, 0792,
0794
AUDIOSONIC 0064, 0136
BANG & OLUFSEN 0592
BASIC 0036
BAUR 0064, 0388, 0539
BAUYSONIC 0207
BEAUMARK 0205
BEKO 0397, 0513, 0741,
0742
BELL & HOWELL 0181
BEON 0064
BLAUPUNKT 0222
BLUE SKY 0695, 1064
BONDSTEC 0274
BRADFORD 0207
BRANDT 0136, 0362
BROKSONIC 0263, 0490
BUSH 0036, 0064, 0398,
0401, 0695, 1064
CCE 0064
CGE 0274
CTC 0274
CXC 0207
CANDLE 0057
CARNIVALE 0057
CARVER 0081, 0197
CASCADE 0036
CATHAY 0064
CELEBRITY 0027
CELERA 0792
CENTURION 0064
CHANGHONG 0792
CHING TAI 0036, 0119
CHUN YUN 0027, 0036, 0119,
0207
CHUNG HSIN 0080, 0135, 0207
CIMLINE 0036
CINERAL 0119, 0478
CITIZEN 0057, 0087, 0119
CLARION 0207
CLARIVOX 0064
CLATRONIC 0274, 0397
CONDOR 0347, 0397
CONRAC 0835

CONTEC	0036, 0207	GRANADA	0064, 0235, 0366, 0543	MAGNADYNE	0274, 0543	PHILIPS	0027, 0057, 0064, 0078, 0081, 0119, 0135, 0205, 0401, 0583, 0717, 1481
CRAIG	0207			MAGNAFON	0543		
CROSLEY	0081	GRANDIN	0637	MAGNAVOX	0057, 0081, 1281, 1481		
CROWN	0036, 0064, 0207, 0397, 0445	GRUNDIG	0064, 0222, 0514, 0583, 0614	MANESTH	0291, 0347	PHONOLA	0064
CURTIS MATHES	0057, 0074, 0081, 0087, 0120, 0172, 0181, 0193, 0478, 0729, 1174, 1374	GRUNPY	0207	MARANTZ	0057, 0064, 0081, 0583	PILOT	0057
		HCM	0036, 0439	MARK	0064	PIONEER	0136, 0190, 0193, 0314, 0706, 0787, 0893
		HALLMARK	0205	MATSUI	0036, 0064, 0235, 0398, 0514, 0543	PORTLAND	0119
DAEWOO	0036, 0057, 0064, 0119, 0135, 0181, 0197, 0205, 0207, 0401, 0478, 0650, 0661, 1688	HANKOOK	0057, 0205, 0207	MATSUSHITA	0277, 0677	PRANDONI-PRINCE	0543
		HANSEATIC	0064, 0347, 0388, 0455, 0583	MEDIATOR	0064	PRIMA	0788
		HANTAREX	0543	MEDION	0695, 0835, 1064	PRISM	0078
		HARMAN/KARDON	0081	MEGATRON	0172, 0205	PROFEX	0036, 0388
		HARVARD	0207	MEMOREX	0036, 0177, 0181, 0205, 0277, 0490, 1064	PROSCAN	0074
		HAVERMY	0120	METZ	0474	PROTECH	0036, 0064, 0274, 0291, 0445, 0695
DANSAI	0064	HELLO KITTY	0478	MICROMAXX	0835	PROTON	0036, 0057, 0205
DAYTON	0036	HINARI	0036, 0064	MICROSTAR	0835	PULSAR	0044
DE GRAAF	0235, 0575	HISAWA	0482	MIDLAND	0044, 0074, 0078	QUASAR	0078, 0277, 0677
DECCA	0064, 0543	HITACHI	0036, 0057, 0119, 0132, 0136, 0172, 0190, 0205, 0252, 0383, 0508, 0575, 0605, 1172, 1283	MINERVA	0514	QUELLE	0064, 0131, 0388, 0539
DENON	0172			MINOKA	0439	R-LINE	0064
DIGATRON	0064	HUA TUN	0036	MITSUBISHI	0057, 0120, 0135, 0177, 0181, 0205, 0207, 0263, 0277, 0539, 0863, 1277	RCA	0027, 0057, 0074, 0117, 0119, 0205, 0706, 1074, 1174, 1274, 1374, 1474, 1481, 1574
DIXI	0036, 0064	HUANYU	0401	MIVAR	0318, 0319, 0543, 0636	RFT	0455
DUMONT	0044	HYPSON	0064, 0291	MOTOROLA	0120	RADIOSHACK	0057, 0074, 0181, 0205, 0207
DWIN	0747, 0801	ICE	0291, 0398	MULTITECH	0036, 0207	RADIOMARELLI	0543
ECE	0064	ITS	0398	MYRYAD	0583	REALISTIC	0057, 0181, 0205, 0207
ELBE	0286	ITT	0190, 0388, 0575	NAD	0183, 0205, 0388, 0893	REDIFFUSION	0388
ELECTROBAND	0027	IMPERIAL	0274, 0397, 0445	NEC	0036, 0057, 0078, 0181, 0183, 0197, 0205, 0482, 0524, 1731	REOC	0741
ELIN	0064, 0575	INDIANA	0064	NEI	0064	REVOX	0064
ELITE	0347	INFINITY	0081	NTC	0119	REX	0190, 0286, 0291
ELTA	0036	INGELEN	0190	NECKERMANN	0064, 0583	ROADSTAR	0036, 0291, 0445
EMERSON	0181, 0205, 0207, 0263, 0388, 0490, 0650	INNO HIT	0543	NETSAT	0064	RUNCO	0044, 0057, 0524, 0630
ENVISION	0057, 0840	INNOVA	0064	NEWAVE	0036, 0119, 0120, 0205	SBR	0064
EPSON	0860	INTEQ	0044	NIKKAI	0064, 0291	SEG	0291, 0695
ERRES	0064	INTERFUNK	0064, 0190, 0274, 0388, 0539	NIKKO	0057, 0119, 0205	SEI	0543
ETHER	0036, 0057	INTERVISION	0064, 0291, 0404	NOKIA	0388, 0500, 0507, 0575, 0658	SKY	0064
ETRON	0036	JBL	0081	NORCENT	0775, 0851	SSS	0207
EUROPHON	0543	JCB	0027	NORDMENDE	0136, 0314, 0587	SABA	0136, 0190, 0314, 0362
FERGUSON	0064, 0100, 0136, 0265, 0314, 0362, 0587	JVC	0080, 0398, 0490, 0680, 0710	OCEANIC	0190, 0388	SACCS	0265
		JEAN	0036, 0078, 0119, 0183, 0263	ONWA	0207, 0460	SAGEM	0637
FIDELITY	0388	JENSEN	0788	OPTIMUS	0181, 0193, 0277, 0677	SAISHO	0036, 0291, 0543
FINLANDIA	0235, 0373	KEC	0207	OPTONICA	0120	SALORA	0190, 0380, 0388, 0575
FINLUX	0064, 0131, 0132, 0373, 0543	KTV	0057, 0207	ORION	0064, 0263, 0347, 0490, 0543	SAMBERS	0543
FIRSTAR	0036, 0263	KAISUI	0036	OSAKI	0291, 0439	SAMPO	0036, 0057, 0119, 0120, 0181, 0198, 0205, 0677, 1782
FIRSTLINE	0036, 0274, 0695	KAPSCH	0190	OTTO VERSAND	0064, 0347, 0539, 0583	SAMSUNG	0036, 0057, 0064, 0087, 0117, 0119, 0181, 0205, 0291, 0397, 0583, 0614, 0645, 0729, 0793, 0839, 0841
FISHER	0131, 0181, 0235, 0397	KARCHER	0637	PALLADIUM	0397, 0445	SANSEI	0478
FLINT	0482	KATHREIN	0583	PANAMA	0291	SANSUI	0490
FORMENTI	0064, 0347	KENDO	0064	PANASONIC	0064, 0078, 0081, 0190, 0277, 0677, 1437	SANYO	0131, 0181, 0207, 0235, 0366, 0826
FORTRESS	0120	KENWOOD	0057			SCHAUB LORENZ	0388
FRONTECH	0190, 0274, 0291	KNEISSEL	0286, 0462			SCHNEIDER	0064, 0274, 0398, 0695
FUJITSU	0710, 0836	KOLIN	0080, 0135, 0207			SCOTCH	0205
FUNAI	0207, 0198, 0291	KORPEL	0064			SCOTT	0205, 0207, 0263
FUTURETECH	0207	KOYODA	0036				
GE	0057, 0074, 0078, 0119, 0205, 0207, 0478, 0587, 1174, 1374, 1481	L&S ELECTRONIC	0835				
GEC	0064, 0543	LG	0057, 0064, 0087, 0135, 0205, 0741				
GATEWAY	1782, 1783	LXI	0074, 0081, 0181, 0183, 0205				
GELOSO	0036	LEYCO	0064, 0291				
GENEXXA	0190	LIESENK & TTER	0064				
GIBRALTER	0044, 0057	LOEWE	0539				
GOLDSTAR	0057, 0064, 0136, 0181, 0205, 0404	LUXOR	0383, 0388	PATHE CINEMA	0265, 0347		
GOODMANS	0064, 0398, 0401, 0661	M ELECTRONIC	0036, 0064, 0131, 0132, 0136, 0190, 0314, 0373, 0401, 0507	PAUSA	0036		
GOREMJE	0397			PENNEY	0057, 0074, 0078, 0087, 0183, 0205, 1374		
GRADIENTE	0080, 0197			PERDIO	0347		
GRAETZ	0190, 0388	MGA	0057, 0177, 0205	PHILCO	0057, 0064, 0081, 0172, 0205, 0207, 0274, 0490, 1688		
		MTC	0057, 0087, 0539				

SEARS	0074, 0081, 0181, 0183, 0198, 0205	UHER	0347	COMBITECH	0379	KAISUI	0099
SELECO	0190, 0286	UNIVERSUM	0064, 0131, 0132, 0291, 0373, 0397, 0519	CRAIG	0064, 0074, 0099, 0267	KENWOOD	0068, 0094
SEMIVOX	0207			CROWN	0099, 0305	KODAK	0062, 0064
SEMP	0183	VECTOR RESEARCH	0057	CURTIS MATHES	0062, 0068, 0087, 1062	KOLIN	0068, 0070
SHARP	0057, 0120, 0677	VESTEL	0064	CYBERNEX	0267	KORPEL	0099
SHEN YING	0036, 0119	VICTOR	0080, 0277, 0677, 0680	CYRUS	0108	LG	0064, 0069, 0072, 0507
SHENG CHIA	0036, 0120, 0263	VIDEOSAT	0274	DAEWOO	0072, 0131, 0305, 0669, 1305	LXI	0064
SIAREM	0543	VIDIKRON	0081	DANSAI	0099	LENCO	0305
SIEMENS	0064, 0222	VIDTECH	0205	DE GRAAF	0069	LEYCO	0099
SINUDYNE	0543	VIEWSONIC	1782	DECCA	0027, 0108	LLOYD'S	0027
SKANTIC	0383	VISION	0347	DENON	0069	LOEWE	0064, 0108, 1589
SKYGIANT	0207	VOXSON	0190	DUAL	0068	LOGIK	0099, 0267
SKYWORTH	0064	WALTHAM	0383	DUMONT	0027, 0108, 0131	LUXOR	0070, 0075, 0131
SOLAVOX	0190	WARDS	0057, 0081, 0205, 0893	DYNATECH	0027	M ELECTRONIC	0027
SONITRON	0235	WATSON	0064, 0347	ESC	0267, 0305	MEI	0062
SONOKO	0036, 0064	WAYCON	0183	ELCATECH	0099	MGA	0070, 0267
SONOLOR	0190, 0235	WHITE WESTINGHOUSE	0064, 0347, 0490, 0650	ELECTROHOME	0064	MGN TECHNOLOGY	0267
SONTEC	0064	Yamaha	0057, 0172, 0677, 0796, 0860, 2900 (projector), 2901 (projector), 2903, 2904 (projector)	ELECTROPHONIC	0064	MTC	0027, 0267
SONY	0027, 0677, 0861, 1127, 1532, 1678			EMEREX	0059	MAGNASONIC	1305
SOUNDESIGN	0205, 0207			EMERSON	0027, 0062, 0064, 0070, 0072, 0211, 0267, 0305, 1305, 1506	MAGNAVOX	0027, 0062, 0066, 0108, 1808
SOUNDWAVE	0064, 0445			FERGUSON	0068, 0347	MAGNIN	0267
SOWA	0078, 0087, 0119, 0183, 0205			FIDELITY	0027	MANESTH	0072, 0099
SQUAREVIEW	0198			FINLANDIA	0108, 0131	MARANTZ	0062, 0108
STANDARD	0036	YAPSHE	0277	FINLUX	0027, 0069, 0108, 0131	MARTA	0064
STARLITE	0207	YOKO	0064, 0291	FIRSTLINE	0064, 0070, 0072, 0099	MATSUI	0375, 0379
STERN	0190, 0286	ZENITH	0044, 0119, 0205, 0490	FISHER	0074, 0131	MATSUSHITA	0062
SUPREME	0027			FUJI	0060, 0062	MEDION	0375
SYLVANIA	0057, 0081, 0198			FUJITSU	0027, 0072	MEMOREX	0027, 0062, 0064, 0066, 0074, 0075, 0131, 0267, 0334, 0375, 1264
SYMPHONIC	0198, 0207			FUNAI	0027	MEMPHIS	0099
SYNCO	0027, 0087, 0119, 0120, 0205, 0478			GE	0062, 0087, 0267, 0834, 1062, 1087	METZ	0064, 0374, 1589
SYSLINE	0064			GEC	0108	MINOLTA	0069
T + A	0474			GARRARD	0027	MITSUBISHI	0068, 0070, 0094, 0108, 0834
TCM	0835			GENERAL	0072	MOTOROLA	0062, 0075
TMK	0205			GO VIDEO	0459	MULTITECH	0027, 0099
TNCI	0044			GOLDHAND	0099	MURPHY	0027
TVS	0490			GOLDSTAR	0064, 0252, 0507, 1264	MYRYAD	0108
TACICO	0036, 0119, 0205			GOODMANS	0027, 0064, 0099, 0305	NAD	0131
TAI YI	0036			GRADIENTE	0027	NEC	0062, 0064, 0068, 0075, 0094, 0131
TANDY	0120, 0190			GRAETZ	0068, 0131, 0267	NATIONAL	0253
TASHIKO	0119, 0677			GRANADA	0108, 0131	NECKERMANN	0108
TATUNG	0036, 0064, 0078, 0081, 0087, 0181, 0183, 0543			GRANDIN	0027, 0064, 0099	NESCO	0099
TEAC	0036, 0064, 0291, 0439, 0445, 0482, 0695, 1064			GRUNDIG	0099, 0108, 0253, 0374	NEWAVE	0064
TEC	0274			HCM	0099	NIKKO	0064
TECHNEMA	0347			HI-Q	0074	NOBLEX	0267
TECHNICS	0078, 0277, 0677			HANSEATIC	0064	NOKIA	0068, 0131, 0267
TECHWOOD	0078			HARLEY DAVIDSON	0027	NORDMENDE	0068, 0347
TECO	0036, 0078, 0119, 0120, 0205, 0291, 0680			HARMAN/KARDON	0108	OCEANIC	0027, 0068
TEKNIKA	0081, 0087, 0119, 0177, 0207			HARWOOD	0099	OKANO	0342, 0375
TELEFUNKEN	0136, 0289, 0362, 0652, 0729			HINARI	0099, 0267, 0379	OLYMPUS	0062, 0253
TELEMEISTER	0347			HITACHI	0027, 0064, 0068, 0069, 0267	OPTIMUS	0064, 0075, 0131, 0459
TELETECH	0036			HUGHES NETWORK SYSTEMS	0069	ORION	0211, 0375, 0379, 1506
TENSAI	0347			HYPSON	0099	OSAKI	0027, 0064, 0099
TERA	0057			ITT	0068, 0131, 0267	OTTO VERSAND	0108
THOMSON	0136, 0314, 0587, 0652, 1474			ITV	0064, 0305	PALLADIUM	0064, 0068, 0099
THORN	0064, 0131, 0388, 0539			IMPERIAL	0027	PANASONIC	0062, 0252, 0253, 0643, 1062, 1589
TOSHIBA	0087, 0181, 0183, 0535, 0645, 0677, 0859, 1283, 1383, 1683, 1731			INTERFUNK	0108	PATHE MARCONI	0068
TRIUMPH	0543			JVC	0068, 0072, 0094	PENNEY	0062, 0064, 0069, 0267, 1062, 1264
TUNTEX	0036, 0057, 0119			JENSEN	0068	PENTAX	0069
				KEC	0064, 0305	PERDIO	0027
				KLH	0099	PHILCO	0062
						PHILIPS	0062, 0108, 0645, 1108, 1208
						PHONOLA	0108

VCR

ASA	0064, 0108
ADMIRAL	0075
ADVENTURA	0027
AIKO	0305
AIWA	0027, 0064, 0334, 0375, 0379
AKAI	0068, 0342
AKIBA	0099
ALBA	0099, 0305, 0342, 0379
AMERICA ACTION	0305
AMERICAN HIGH	0062
AMSTRAD	0027
ANAM	0064, 0253, 0267, 0305, 0507
ANAM NATIONAL	0253, 1589
ANITECH	0099
ASHA	0267
ASUKA	0064
AUDIOVOX	0064, 0305
BAIRD	0027, 0068, 0131
BASIC LINE	0099, 0305
BEAUMARK	0267
BELL & HOWELL	0131
BLAUPUNKT	0253
BRANDT	0347
BRANDT ELECTRONIC	0068
BROKSONIC	0211, 0375, 1506
BUSH	0099, 0305, 0379
CCE	0099, 0305
CGE	0027
CALIX	0064
CANON	0062
CARVER	0108
CIMLINE	0099
CINERAL	0305
CITIZEN	0064, 0305, 1305
COLT	0099

PILOT	0064	TELEAVIA	0068
PIONEER	0069, 0094, 0108	TELEFUNKEN	0068, 0347
POLK AUDIO	0108	TENOSAL	0099
PROFITRONIC	0267	TENSAI	0027
PROLINE	0027	THOMAS	0027
PROSCAN	0087, 1087	THOMSON	0068, 0087, 0094,
PROTEC	0099		0347
PULSAR	0066	THORN	0068, 0131
PYE	0108	TIVO	0645, 0663
QUASAR	0062, 1062	TOSHIBA	0068, 0070, 0072,
QUELLE	0108		0094, 0108, 0872
RCA	0062, 0069, 0087,	TOTEVISION	0064, 0267
	0267, 0834, 1062,	UHER	0267
	1087	UNITECH	0267
RADIOSHACK	0027	UNIVERSUM	0027, 0064, 0108,
RADIOLA	0108		0267
RADIX	0064	VECTOR	0072
RANDEX	0064	VICTOR	0068, 0094
REALISTIC	0027, 0062, 0064,	VIDEO CONCEPTS	0072
	0074, 0075, 0131	VIDEOMAGIC	0064
REOC	0375	VIDEOSONIC	0267
REPLAYTV	0641, 0643	VILLAIN	0027
REX	0068	WARDS	0027, 0062, 0069,
ROADSTAR	0064, 0099, 0267,		0074, 0075, 0087,
	0305		0099, 0108, 0267
RUNCO	0066	WHITE WESTINGHOUSE	
SBR	0108		0099
SEG	0267	XR-1000	0027, 0062, 0099
SEI	0108	Yamaha	0068
STS	0069	YAMISHI	0099
SABA	0068, 0347	YOKAN	0099
SALORA	0070	YOKO	0267
SAMPO	0064, 0075	ZENITH	0027, 0060, 0066,
SAMSUNG	0072, 0267, 0459		1506
SANKY	0066, 0075		
SANSUI	0027, 0068, 0094,		
	1506		
SANYO	0074, 0131, 0267		
SAVILLE	0379		
SCHAUB LORENZ	0027, 0068,		
	0131		
SCHNEIDER	0027, 0099, 0108		
SCOTT	0070, 0072, 0211		
SEARS	0027, 0062, 0064,		
	0069, 0074, 0131,		
	1264		
SELECO	0068		
SEMP	0072		
SHARP	0075, 0834		
SHINTOM	0099, 0131		
SIEMENS	0064, 0108, 0131		
SILVA	0064		
SINGER	0072, 0099		
SINUDYNE	0108		
SONIC BLUE	0641, 0643		
SONTEC	0064		
SONY	0027, 0059, 0060,		
	0062, 0663, 1259		
SUNKAI	0375		
SUNSTAR	0027		
SUNTRONIC	0027		
SYLVANIA	0027, 0062, 0108,		
	0070, 1808		
SYMPHONIC	0027		
TMK	0267		
TANDY	0027, 0131		
TASHIKO	0027, 0064		
TATUNG	0027, 0068, 0072,		
	0094, 0108		
TEAC	0027, 0068, 0305,		
	0334, 0669		
TECHNICS	0062, 0253		
TECO	0062, 0064, 0068,		
	0075		
TEKNIKA	0027, 0062, 0064		



© 2007 YAMAHA CORPORATION All rights reserved.

YAMAHA ELECTRONICS CORPORATION, USA 6660 ORANGETHORPE AVE., BUENA PARK, CALIF. 90620, U.S.A.
YAMAHA CANADA MUSIC LTD. 135 MILNER AVE., SCARBOROUGH, ONTARIO M1S 3R1, CANADA
YAMAHA ELECTRONIK EUROPA G.m.b.H. SIEMENSSTR. 22-34, 25462 RELLINGEN BEI HAMBURG, GERMANY
YAMAHA ELECTRONIQUE FRANCE S.A. RUE AMBROISE CROIZAT BP70 CROISSY-BEAUBOURG 77312 MARNE-LA-VALLEE CEDEX02, FRANCE
YAMAHA ELECTRONICS (UK) LTD. YAMAHA HOUSE, 200 RICKMANSWORTH ROAD WATFORD, HERTS WD18 7GQ, ENGLAND
YAMAHA SCANDINAVIA A.B. J.A. WETTERGRENS GATA 1, BOX 30053, 400 43 VÄSTRA FRÖLUNDA, SWEDEN
YAMAHA MUSIC AUSTRALIA PTY, LTD. 17-33 MARKET ST., SOUTH MELBOURNE, 3205 VIC., AUSTRALIA

YAMAHA CORPORATION
Printed in Malaysia © WK69470

The circled numbers and alphabets correspond to those in the Owner's Manual.
Les nombres et lettres dans un cercle correspondent à ceux du mode d'emploi.

■ **Front panel/Face avant**

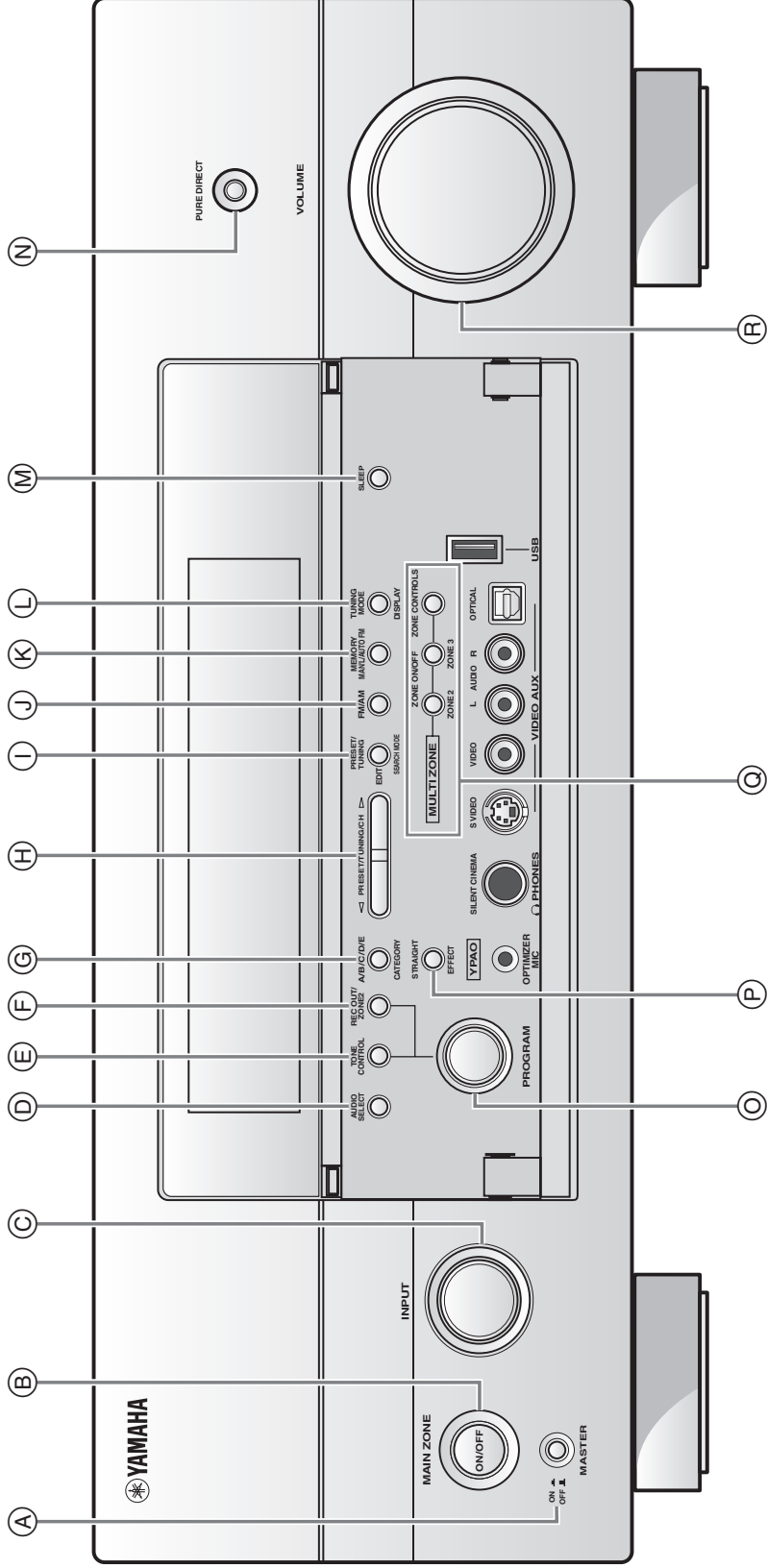

Remote control/Boîtier de télécommande

